

Einhell

GC-WW 6538

D	Originalbetriebsanleitung Hauswasserwerk	NL	Originele handleiding Watervoorzieningsinstallatie
GB	Original operating instructions Home waterworks	E	Manual de instrucciones original Sistema doméstico de bombeo de agua
F	Instructions d'origine Systemes domestiques de distri- bution d'eau	FIN	Alkuperäiskäyttöohje Kotitalousvesilaitos
I	Istruzioni per l'uso originali Centralina idrica	SLO	Originalna navodila za uporabo Hišni vodovod
DK/ N	Original betjeningsvejledning Husvandværk	GR	Πρωτότυπες Οδηγίες χρήσης Υδρονομική οικιακή εγκατάσταση
S	Original-bruksanvisning Hushållsvattenverk		



Art.-Nr.: 41.731.90

I.-Nr.: 11029

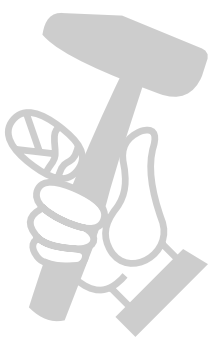
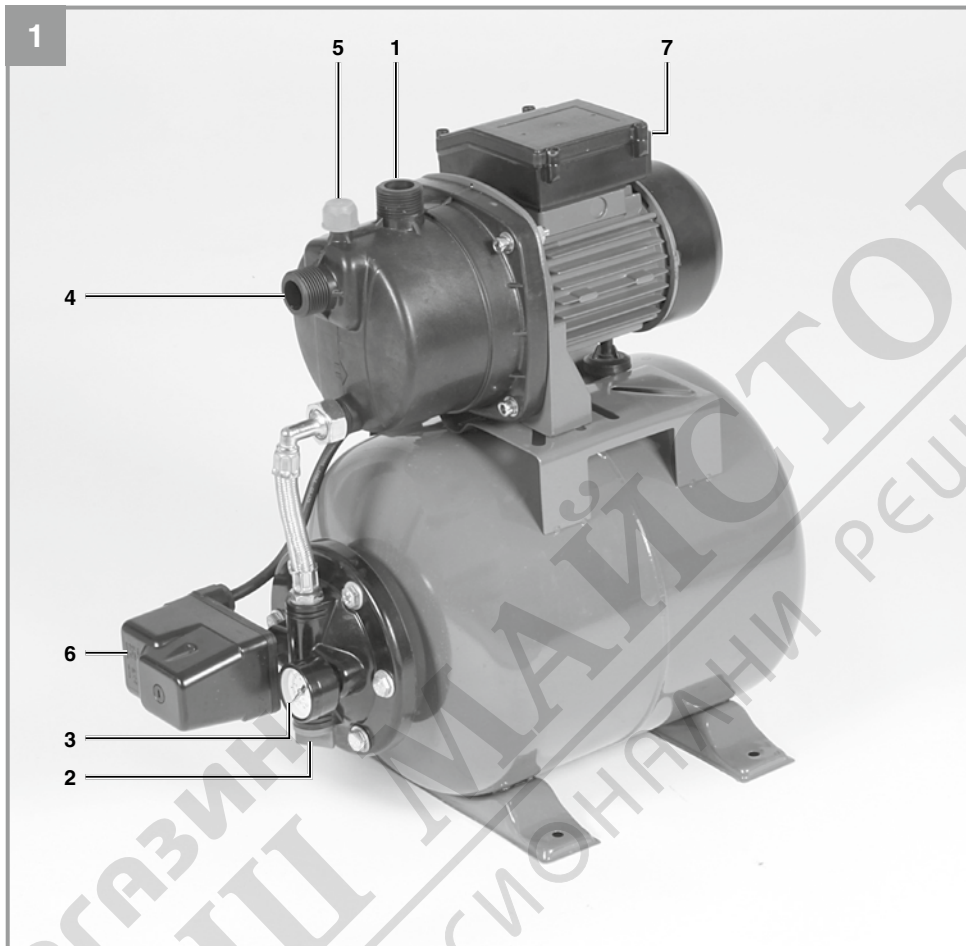

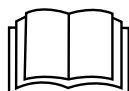

Danger! - Read the operating instructions to reduce the risk of injury

МАГАЗИН МАЙСТОРА
БАШ ПРОФЕСИОНАЛНИ РЕШЕНИЯ

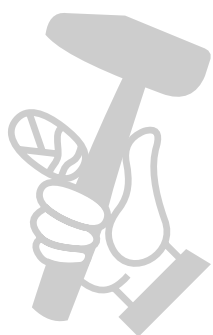

This equipment can be used by children of 8 years and older and by people with limited physical, sensory or mental capacities or those with no experience and knowledge if they are supervised or have received instruction in how to use the equipment safely and understand the dangers which result from such use. Children are not allowed to play with the equipment. Unless supervised, children are not allowed to clean the equipment and carry out user-level maintenance work.

Danger!

When using the equipment, a few safety precautions must be observed to avoid injuries and damage. Please read the complete operating instructions and safety regulations with due care. Keep this manual in a safe place, so that the information is available at all times. If you give the equipment to any other person, hand over these operating instructions and safety regulations as well. We cannot accept any liability for damage or accidents which arise due to a failure to follow these instructions and the safety instructions.

1. Safety regulations

The corresponding safety information can be found in the enclosed booklet.

Danger!

Read all safety regulations and instructions.

Any errors made in following the safety regulations and instructions may result in an electric shock, fire and/or serious injury.

Keep all safety regulations and instructions in a safe place for future use.

2. Layout and items supplied**2.1 Layout (Fig. 1)**

1. Pressure connector (R1 male thread)
2. Water drain screw
3. Pressure gauge
4. Suction connector (R1 male thread)
5. Water filler screw
6. Pressure switch
7. Power switch

2.2 Items supplied

Please check that the article is complete as specified in the scope of delivery. If parts are missing, please contact our service center or the sales outlet where you made your purchase at the latest within 5 working days after purchasing the product and upon presentation of a valid bill of purchase. Also, refer to the warranty table in the service information at the end of the operating instructions.

- Open the packaging and take out the equipment with care.
- Remove the packaging material and any packaging and/or transportation braces (if available).
- Check to see if all items are supplied.

- Inspect the equipment and accessories for transport damage.
- If possible, please keep the packaging until the end of the guarantee period.

Danger!

The equipment and packaging material are not toys. Do not let children play with plastic bags, foils or small parts. There is a danger of swallowing or suffocating!

- Domestic waterworks
- Original operating instructions
- Safety instructions

3. Proper use**Applications**

- Irrigation and watering of green areas, vegetable beds and gardens.
- Operation of lawn sprinklers.
- For drawing water from ponds, streams, rainwater butts, rainwater cisterns and springs
- For supplying service water

Transport media:

- For the pumping of clear water (fresh water), rainwater or light suds/service water.
- The maximum temperature of the fluid must not exceed +35°C if the equipment is operated permanently.
- Do not use the equipment to pump inflammable, gassing or explosive fluids.
- The pumping of aggressive liquids (acids, alkalis, silo seepage etc.) as well as liquids with abrasive substances (sand) must likewise be avoided.
- This equipment is not designed to convey drinking water.

The equipment is to be used only for its prescribed purpose. Any other use is deemed to be a case of misuse. The user / operator and not the manufacturer will be liable for any damage or injuries of any kind caused as a result of this.

Please note that our equipment has not been designed for use in commercial, trade or industrial applications. Our warranty will be voided if the machine is used in commercial, trade or industrial businesses or for equivalent purposes.

4. Technical data

Mains connection:..... 220-240 V ~ 50 Hz
 Power consumption:..... 650 W
 Pumping rate max. 3800 l/h
 Delivery head max. 36 m
 Delivery pressure max. 0.36 MPa (3.6 bar)
 Suction height max. 8 m
 Pressure connection: approx. 33.3 mm (R1 male thread)
 Suction connection: approx. 33.3 mm (R1 male thread)
 Water temperature max..... 35°C
 Tank capacity:..... 20 l
 Cut-in pressure approx.:..... 0.15 MPa (1.5 bar)
 Cut-out pressure approx.: 0.3 MPa (3 bar)
 Protection type:..... IPX4

5. Before starting the equipment

Before you connect the equipment to the mains supply make sure that the data on the rating plate are identical to the mains data.

As a basic principle, we recommend the use of a preliminary filter and a suction set with suction hose, intake cage and non-return valve, in order to prevent long priming periods and unnecessary damage to the pump as a result of stones and solid foreign bodies.

5.1 Connecting the intake line

- Fasten the suction hose (at least approx. 19 mm (¾") plastic hose with spiral reinforcement) to the suction connection approx. 33.3 mm (R1 male thread) of the equipment either directly or via a threaded nipple.
- The suction hose used should be equipped with an intake valve. If the intake valve cannot be used, a non-return valve should be installed in the intake line.
- Position the intake line so that it rises from the water withdrawal point to the equipment. Avoid positioning the intake line higher than the pump, as this would delay the escape of air bubbles from the intake line and impede the priming process.
- Install the intake and discharge lines in such a way that they do not exert any mechanical pressure on the equipment.

- The intake valve should be low enough in the water to ensure that if the water level falls, the unit will not run dry.
- A leaking intake line will draw in air and therefore not draw in any water.
- Prevent the intake of foreign bodies (sand, etc.). If necessary, install a coarse filter for this purpose.

5.2 Connecting the discharge line

- The discharge line (min. 19 mm (¾") must be connected to the 33.3 mm (R1 male thread) female thread discharge line connector of the equipment either directly or with the aid of a threaded nipple.
- With the right couplings it is also possible, of course, to use a 13 mm (½") delivery hose. The smaller delivery hose results in a lower delivery rate.
- During the priming operation, fully open any shut-off mechanisms (spray nozzles, valves, etc.) in the pressure line so that the air can escape without obstruction.

5.3 Electrical connections

- Connect the appliance to a 220-240 V ~ 50 Hz socket-outlet with earthing contact. Minimum fuse 10 ampere.
- A built-in thermostat protects the motor from overloading and blocking. The pump is switched off automatically by the thermostat if overheating occurs and is switched on again automatically after cooling.

6. Operation

- Install the equipment on a solid and level surface.
- Fill the pump housing with water via the water filler screw (5). Filling the intake line will accelerate the priming process.
- All the shut-off devices in the discharge line (spray nozzle, valves etc.) must be fully opened during intake in order to permit all air to escape from the intake line.
- Connect the mains cable.
- Switch on the equipment with the power switch (7) - water can be suctioned in for up to 5 minutes (maximum suction height).
- The equipment will shut down when the cut-out pressure of 3 bar is reached.
- After a loss of pressure due to water consumption the equipment will cut in again automatically (cut-in pressure approx. 1.5 bar).

- After finishing the work, switch off the equipment with the power switch (7).

7. Replacing the power cable

Danger!

If the power cable for this equipment is damaged, it must be replaced by the manufacturer or its after-sales service or similarly trained personnel to avoid danger.

8. Cleaning, maintenance and ordering of spare parts

The equipment is almost completely maintenance free. In order to ensure a long service life, however, we recommend that you regularly check and care for the product.

Danger!

The equipment must be disconnected from the power supply (pull the power plug) prior to performing any maintenance.

8.1 Servicing

- If the equipment becomes clogged, connect the discharge line to the water line and disconnect the suction hose. Open the water line. Switch on the equipment several times for approx. two seconds. This should resolve the majority of clog-related problems.
- Inside the pressure tank is an expandable water sack and an air compartment whose maximum pressure should lie at approx. 1.5 bar. Pumping water into the water sack causes the sack to expand so that the pressure in the air compartment rises to switch-off level. If the air pressure is too low, you should raise it. To do so, unscrew the plastic lid from the tank and top up the pressure to the correct level using a tyre pump with meter at the valve.
Important: Be sure to completely empty the water bag first using the water drain screw (2).
- Replacing the mains cable: Important: Disconnect the equipment from the power supply! A defective mains cable may only be replaced by a qualified electrician.
- There are no parts inside the equipment which require additional maintenance.

8.2 Ordering replacement parts:

Please quote the following data when ordering replacement parts:

- Type of machine
- Article number of the machine
- Identification number of the machine
- Replacement part number of the part required

For our latest prices and information please go to www.isc-gmbh.info

9. Disposal and recycling

The equipment is supplied in packaging to prevent it from being damaged in transit. The raw materials in this packaging can be reused or recycled. The equipment and its accessories are made of various types of material, such as metal and plastic. Never place defective equipment in your household refuse. The equipment should be taken to a suitable collection center for proper disposal. If you do not know the whereabouts of such a collection point, you should ask in your local council offices.

10. Storage

Store the equipment and accessories in a dark and dry place at above freezing temperature. The ideal storage temperature is between 5 and 30 °C. Store the electric tool in its original packaging.

- If the pump is not going to be used for a long time or has to be removed for the winter months, rinse it out with water, empty it completely and allow it to dry.
- The equipment must be completely drained before it is subjected to frost.
- After long stoppages, make sure the rotor turns correctly by briefly switching the pump on and off.

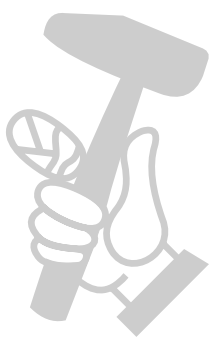

11. Troubleshooting guide

Faults	Cause	Remedy
Motor fails to start up	<ul style="list-style-type: none"> - No mains voltage - Pump rotor blocked -thermostat switched off 	<ul style="list-style-type: none"> - Check voltage - Dismantle and clean pump
No intake	<ul style="list-style-type: none"> - Intake valve not in water - Pump chamber without water connection - Air in intake line air-tight - Intake valve leaks - Strainer (intake valve) blocked - Max. suction height exceeded 	<ul style="list-style-type: none"> - Immerse intake valve in water - Fill water into intake - Make sure intake line is close - Clean intake valve - Clean strainer - Check suction height
Inadequate delivery rate	<ul style="list-style-type: none"> - Suction height too high - Strainer dirty - Water level falling rapidly - Pump performance diminished by contaminants part 	<ul style="list-style-type: none"> - Check suction height - Clean strainer - Place the suction hose at a deeper level - Clean pump and replace wearing
Thermostat switches pump off	<ul style="list-style-type: none"> - Motor overloaded - friction caused by foreign substances too high 	<ul style="list-style-type: none"> - Dismantle and clean pump. Prevent intake of foreign substances (filter)

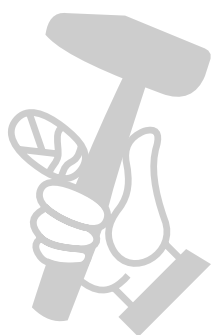



For EU countries only

Never place any electric power tools in your household refuse.

To comply with European Directive 2012/19/EC concerning old electric and electronic equipment and its implementation in national laws, old electric power tools have to be separated from other waste and disposed of in an environment-friendly fashion, e.g. by taking to a recycling depot.

Recycling alternative to the return request:

As an alternative to returning the equipment to the manufacturer, the owner of the electrical equipment must make sure that the equipment is properly disposed of if he no longer wants to keep the equipment. The old equipment can be returned to a suitable collection point that will dispose of the equipment in accordance with the national recycling and waste disposal regulations. This does not apply to any accessories or aids without electrical components supplied with the old equipment.

The reprinting or reproduction by any other means, in whole or in part, of documentation and papers accompanying products is permitted only with the express consent of the iSC GmbH.

Subject to technical changes

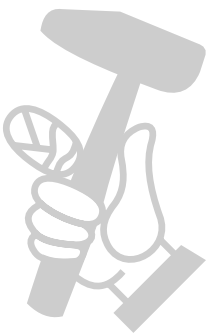

Service information

We have competent service partners in all countries named on the guarantee certificate whose contact details can also be found on the guarantee certificate. These partners will help you with all service requests such as repairs, spare and wearing part orders or the purchase of consumables.

Please note that the following parts of this product are subject to normal or natural wear and that the following parts are therefore also required for use as consumables.

Category	Example
Wear parts*	Coarse filter, filter cartridge, water bag (membrane)
Consumables*	
Missing parts	

* Not necessarily included in the scope of delivery!

In the event of defects or faults, please register the problem on the internet at www.isc-gmbh.info. Please ensure that you provide a precise description of the problem and answer the following questions in all cases:

- Did the equipment work at all or was it defective from the beginning?
- Did you notice anything (symptom or defect) prior to the failure?
- What malfunction does the equipment have in your opinion (main symptom)? Describe this malfunction.

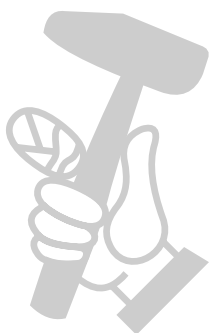

Warranty certificate

Dear Customer,

All of our products undergo strict quality checks to ensure that they reach you in perfect condition. In the unlikely event that your device develops a fault, please contact our service department at the address shown on this guarantee card. You can also contact us by telephone using the service number shown. Please note the following terms under which guarantee claims can be made:

1. These guarantee terms apply to consumers only, i.e. natural persons intending to use this product neither for their commercial activities nor for any other self-employed activities. These warranty terms regulate additional warranty services, which the manufacturer mentioned below promises to buyers of its new products in addition to their statutory rights of guarantee. Your statutory guarantee claims are not affected by this guarantee. Our guarantee is free of charge to you.
2. The warranty services cover only defects due to material or manufacturing faults on a product which you have bought from the manufacturer mentioned below and are limited to either the rectification of said defects on the product or the replacement of the product, whichever we prefer. Please note that our devices are not designed for use in commercial, trade or professional applications. A guarantee contract will not be created if the device has been used by commercial, trade or industrial business or has been exposed to similar stresses during the guarantee period.
3. The following are not covered by our guarantee:
 - Damage to the device caused by a failure to follow the assembly instructions or due to incorrect installation, a failure to follow the operating instructions (for example connecting it to an incorrect mains voltage or current type) or a failure to follow the maintenance and safety instructions or by exposing the device to abnormal environmental conditions or by lack of care and maintenance.
 - Damage to the device caused by abuse or incorrect use (for example overloading the device or the use of unapproved tools or accessories), ingress of foreign bodies into the device (such as sand, stones or dust, transport damage), the use of force or damage caused by external forces (for example by dropping it).
 - Damage to the device or parts of the device caused by normal or natural wear or tear or by normal use of the device.
4. The guarantee is valid for a period of 24 months starting from the purchase date of the device. Guarantee claims should be submitted before the end of the guarantee period within two weeks of the defect being noticed. No guarantee claims will be accepted after the end of the guarantee period. The original guarantee period remains applicable to the device even if repairs are carried out or parts are replaced. In such cases, the work performed or parts fitted will not result in an extension of the guarantee period, and no new guarantee will become active for the work performed or parts fitted. This also applies if an on-site service is used.
5. To make a claim under the guarantee, please register the defective device at: www.isc-gmbh.info. Please keep your bill of purchase or other proof of purchase for the new device. Devices that are returned without proof of purchase or without a rating plate shall not be covered by the guarantee, because appropriate identification will not be possible. If the defect is covered by our guarantee, then the item in question will either be repaired immediately and returned to you or we will send you a new replacement.

Of course, we are also happy offer a chargeable repair service for any defects which are not covered by the scope of this guarantee or for units which are no longer covered. To take advantage of this service, please send the device to our service address.

Also refer to the restrictions of this warranty concerning wear parts, consumables and missing parts as set out in the service information in these operating instructions.