

DEWALT

МАГАЗИН
БАШ МАЙСТОРА
ПРОФЕСИОНАЛНИ РЕШЕНИЯ

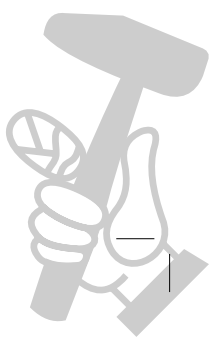

www.DEWALT.com

DCR020

Dansk (oversat fra original brugsvejledning)	3
Deutsch (übersetzt von den Originalanweisungen)	12
English (original instructions)	24
Español (traducido de las instrucciones originales)	34
Français (traduction de la notice d'instructions originale)	44
Italiano (tradotto dalle istruzioni originali)	54
Nederlands (vertaald vanuit de originele instructies)	65
Norsk (oversatt fra de originale instruksjonene)	75
Português (traduzido das instruções originais)	84
Suomi (käännetty alkuperäisestä käyttöohjeesta)	95
Svenska (översatt från de ursprungliga instruktionerna)	104
Türkçe (orijinal talimatlardan çevrilmiştir)	114
Ελληνικά (μετάφραση από τις πρωτότυπες οδηγίες)	124



Figure 1

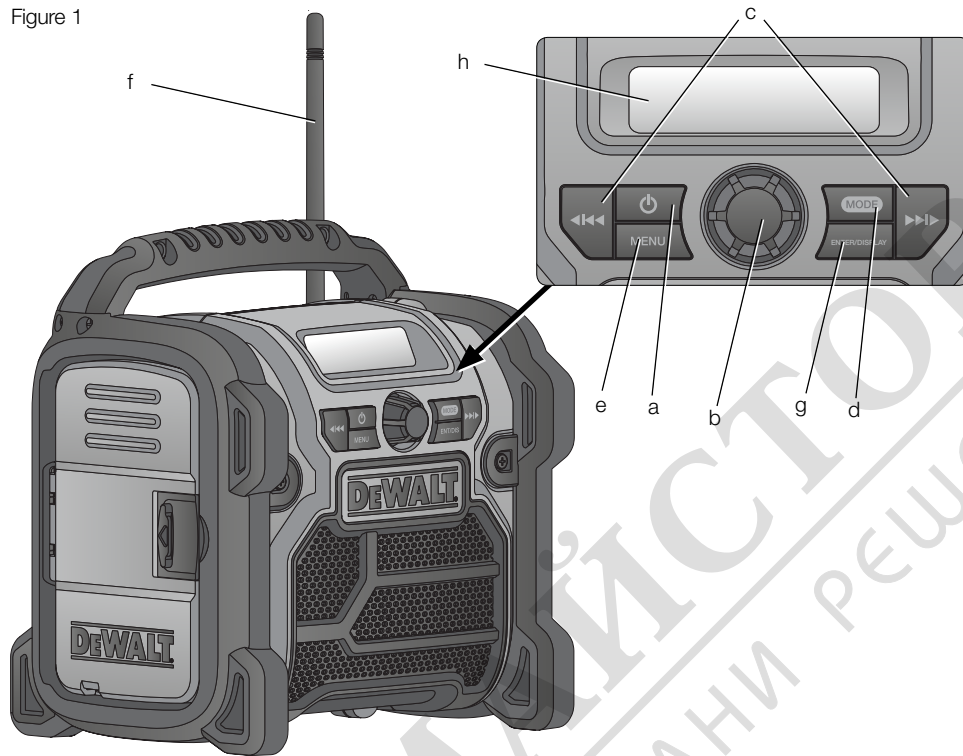

Figure 2

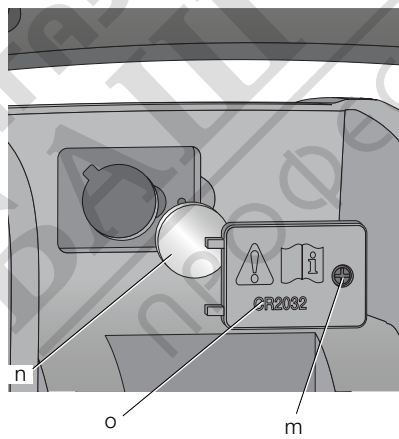

Figure 3

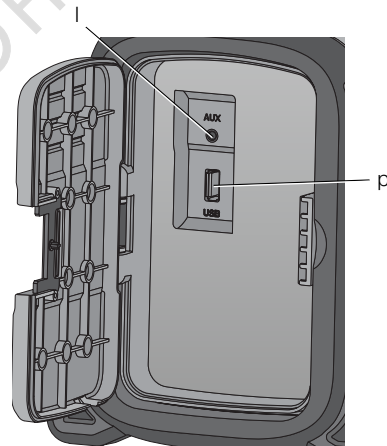
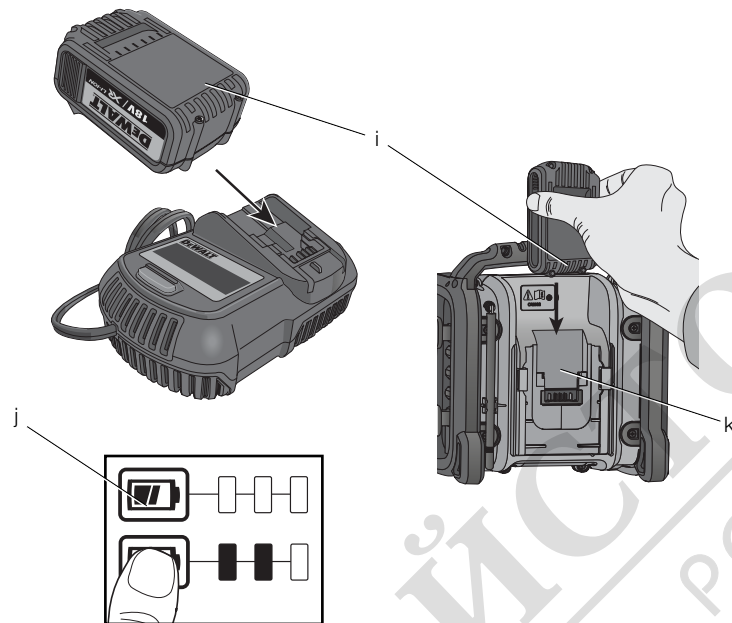

Figure 4



МАГАЗИН МАЙСТОР
БАШ МАЙСТОР
ПРОФЕСІОНАЛНИ РЕШЕННЯ



RADIO

DCR020

Congratulations!

You have chosen a DEWALT product. Years of experience, thorough product development and innovation make DEWALT one of the most reliable partners for professional power tool users.

Technical Data

														DCR020
Power source														AC/DC
Mains voltage														230
Battery voltage														10.8–18
Battery type														Li-Ion
Weight														2.9
Fuses:														
U.K. & Ireland	250 V											3 Amperes, in plugs		
Battery pack	DCB123	DCB125	DCB127	DCB140	DCB141	DCB142	DCB143	DCB144	DCB180	DCB181	DCB182	DCB183	DCB184	
Battery type	Li-Ion	Li-Ion	Li-Ion	Li-Ion	Li-Ion	Li-Ion	Li-Ion	Li-Ion	Li-Ion	Li-Ion	Li-Ion	Li-Ion	Li-Ion	
Voltage	V_{DC}	10.8	10.8	10.8	14.4	14.4	14.4	14.4	14.4	18	18	18	18	
Capacity	A_h	1.5	1.3	2.0	3.0	1.5	4.0	2.0	5.0	3.0	1.5	4.0	2.0	
Weight	kg	0.2	0.2	0.2	0.53	0.30	0.54	0.30	0.54	0.64	0.35	0.61	0.40	
Charger														
														DCB105
Mains voltage														230 V
Battery type														Li-Ion
Approx. charging time of battery packs	min	30 (1,5 Ah)			45 (2,0 Ah)			55 (3,0 Ah)			70 (4,0 Ah)		90 (5,0 Ah)	
Weight														0,49

Definitions: Safety Guidelines

The definitions below describe the level of severity for each signal word. Please read the manual and pay attention to these symbols.



DANGER: Indicates an imminently hazardous situation which, if not avoided, **will** result in **death or serious injury**.



WARNING: Indicates a potentially hazardous situation which, if not avoided, **could** result in **death or serious injury**.



CAUTION: Indicates a potentially hazardous situation which, if not avoided, **may** result in **minor or moderate injury**.

NOTICE: Indicates a practice **not related to personal injury** which, if not avoided, **may** result in **property damage**.



Denotes risk of electric shock.



Denotes risk of fire.

Safety Instructions for Radios

- **Do not abuse cord.** Never carry the radio by its cord. Never pull the cord to disconnect from the socket. Keep the cord away from heat, oil and sharp edges.

- **Remove the battery pack.** Switch off before leaving it unattended. Remove the battery pack when not in use, before changing accessories or attachments and before servicing.
- This appliance is intended to be used in moderate climates.
- This appliance is not intended for use by persons (including children) with reduced physical, sensory or mental capabilities, or lack of experience and knowledge, unless they have been given supervision or instruction concerning use of the appliance by a person responsible for their safety.
- Children should be supervised to ensure that they do not play with the appliance.
- Radio shall not be exposed to dripping or splashing; no objects filled with liquids, such as vases, shall be placed on it.
- No exposed flame sources, such as lighted candles, should be placed on the radio.
- Mains plug is used as the disconnect device; the disconnect device (plug) shall remain readily operable.

Markings on Radio

The following pictograms are shown on the radio:



Read instruction manual.

Important Safety Instructions for All Battery Chargers

SAVE THESE INSTRUCTIONS: This manual contains important safety and operating instructions for the DCB105 battery charger.

- Before using the charger, read all instructions and cautionary markings on charger, battery pack and product using the battery pack.



WARNING: Shock hazard. Do not allow any liquid to get inside charger. Electric shock may result.



CAUTION: Burn hazard. To reduce the risk of injury, charge only DEWALT rechargeable batteries. Other types of batteries may overheat and burst resulting in personal injury and property damage.



CAUTION: Children should be supervised to ensure that they do not play with the appliance.



CAUTION: Danger of explosion if internal battery is incorrectly replaced. Replace only with the same or equivalent type.

NOTICE: Under certain conditions, with the charger plugged in to the power supply, the charger can be shorted by foreign material. Foreign materials of a conductive nature such as, but not limited to, grinding dust, metal chips, steel wool, aluminum foil, or any buildup of metallic particles should be kept away from charger cavities. Always unplug the charger from the power supply when there is no battery pack in the cavity. Unplug charger before attempting to clean.

- **DO NOT attempt to charge the battery pack with any chargers other than the ones in this manual.** The charger and battery pack are specifically designed to work together.
- **These chargers are not intended for any uses other than charging DEWALT rechargeable batteries.** Any other uses may result in risk of fire, electric shock or electrocution.
- **Do not expose charger to rain or snow.**
- **Pull by plug rather than cord when disconnecting charger.** This will reduce risk of damage to electric plug and cord.
- **Make sure that cord is located so that it will not be stepped on, tripped over or otherwise subjected to damage or stress.**
- **Do not use an extension cord unless it is absolutely necessary.** Use of improper extension cord could result in risk of fire, electric shock or electrocution.
- **Do not place any object on top of charger or place the charger on a soft surface that might block the ventilation slots and result in excessive internal heat.** Place the charger in a position away from any heat source. The charger is ventilated through slots in the top and the bottom of the housing.
- **Do not operate charger with damaged cord or plug — have them replaced immediately.**
- **Do not operate charger if it has received a sharp blow, been dropped or otherwise damaged in any way.** Take it to an authorised service centre.

ENGLISH

- **Do not disassemble the charger; take it to an authorised service centre when service or repair is required.** Incorrect reassembly may result in a risk of electric shock, electrocution or fire.
- **Disconnect the charger from the outlet before attempting any cleaning. This will reduce the risk of electric shock.** Removing the battery pack will not reduce this risk.
- **NEVER attempt to connect 2 chargers together.**
- **The charger is designed to operate on standard 230 V household electrical power. Do not attempt to use it on any other voltage.** This does not apply to the vehicular charger.

SAVE THESE INSTRUCTIONS

Chargers

The DCB105 charger accepts 10.8 V, 14.4 V and 18 V Li-Ion (DCB123, DCB125, DCB127, DCB140, DCB141, DCB142, DCB143, DCB144, DCB180, DCB181, DCB182, DCB183 and DCB184) battery packs.

DEWALT chargers require no adjustment and are designed to be as easy as possible to operate.





Charging Procedure (fig. 4)

1. Plug the charger into an appropriate outlet before inserting the battery pack.
2. Insert the battery pack (i) into the charger, making sure the pack is fully seated in the charger. The red (charging) light will blink continuously indicating that the charging process has started.
3. The completion of charge will be indicated by the red light remaining ON continuously. The pack is fully charged and may be used at this time or left in the charger.

NOTE: To ensure maximum performance and life of Li-Ion batteries, charge the battery pack fully before first use.

Charging Process

Refer to the table below for the state of charge of the battery pack.

Charge indicators: DCB105	
	charging — — — — —
	fully charged —————
	hot/cold pack delay — • — • — • —
	replace battery pack ••••••••••••••

This charger will not charge a faulty battery pack. The charger will indicate faulty battery by refusing to light or by displaying problem pack or charger blink pattern.

NOTE: This could also mean a problem with a charger.

If the charger indicates a problem, take the charger and battery pack to be tested at an authorised service centre.

HOT/COLD PACK DELAY

When the charger detects a battery that is too hot or too cold, it automatically starts a Hot/Cold Pack Delay, suspending charging until the battery has reached an appropriate temperature. The charger then automatically switches to the pack charging mode. This feature ensures maximum battery life.

XR Li-Ion tools are designed with an Electronic Protection System that will protect the battery against overloading, overheating or deep discharge.

The tool will automatically turn off if the Electronic Protection System engages. If this occurs, place the Li-Ion battery on the charger until it is fully charged.

A cold battery pack will charge at about half the rate of a warm battery pack. The battery pack will charge at that slower rate throughout the entire charging cycle and will not return to maximum charge rate even if the battery warms.

Important Safety Instructions for All Battery Packs

When ordering replacement battery packs, be sure to include the catalog number and voltage.

The battery pack is not fully charged out of the carton. Before using the battery pack and charger, read the safety instructions below and then follow the charging procedures outlined.

READ ALL INSTRUCTIONS

- **Do not charge or use the battery pack in explosive atmospheres, such as in the presence of flammable liquids, gases or dust.** Inserting or removing the battery pack from the charger may ignite the dust or fumes.
- **Never force the battery pack into charger. Do not modify the battery pack in any way to fit into a non-compatible charger as battery pack may rupture causing serious personal injury.**
- **Charge the battery packs only in designated DEWALT chargers.**
- **DO NOT splash or immerse in water or other liquids.**

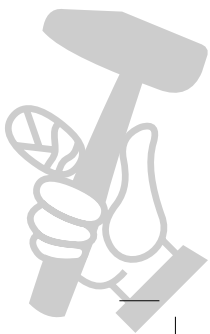

- **Do not store or use the tool and battery pack in locations where the temperature may reach or exceed 40 °C (105 °F) (such as outside sheds or metal buildings in summer).**
- Batteries shall not be exposed to excessive heat such as sunshine, fire or the like.
- For best results, make sure the battery pack is fully charged before use.



WARNING: Never attempt to open the battery pack for any reason. If the battery pack case is cracked or damaged, do not insert it into the charger. Do not crush, drop or damage battery pack. Do not use a battery pack or charger that has received a sharp blow, been dropped, run over or damaged in any way (e.g., pierced with a nail, hit with a hammer, stepped on). Electric shock or electrocution may result. Damaged battery packs should be returned to the service centre for recycling.



CAUTION: When not in use, place tool on its side on a stable surface where it will not cause a tripping or falling hazard. Some tools with large battery packs will stand upright on the battery pack but may be easily knocked over.

SPECIFIC SAFETY INSTRUCTIONS FOR LITHIUM ION (Li-Ion)

- **Do not incinerate the battery pack even if it is severely damaged or is completely worn out.** The battery pack can explode in a fire. Toxic fumes and materials are created when lithium ion battery packs are burned.
- **If battery contents come into contact with the skin, immediately wash the area with mild soap and water.** If the battery liquid gets into the eye, rinse water over the open eye for 15 minutes or until irritation ceases. If medical attention is needed, the battery electrolyte is composed of a mixture of liquid organic carbonates and lithium salts.
- **Contents of opened battery cells may cause respiratory irritation.** Provide fresh air. If symptoms persists, seek medical attention.



WARNING: Burn hazard. Battery liquid may be flammable if exposed to spark or flame.

Transportation

DEWALT batteries comply with all applicable shipping regulations as prescribed by industry and legal standards which include UN Recommendations on the Transport of Dangerous Goods; International Air Transport Association (IATA) Dangerous Goods Regulations, International Maritime Dangerous Goods (IMDG) Regulations, and the European Agreement Concerning The International Carriage of Dangerous Goods by Road (ADR). Lithium-ion cells and batteries have been tested to section 38.3 of the UN Recommendations on the Transport of Dangerous Goods Manual of Tests and Criteria.

In most instances, shipping a DEWALT battery pack will be excepted from being classified as a fully regulated Class 9 Hazardous material. In general, the two instances that require shipping Class 9 are:

1. Air shipping more than two DEWALT lithium-ion battery packs when the package contains only battery packs (no tools), and
2. Any shipment containing a lithium-ion battery with an energy rating greater than 100 watt hours (Wh). All lithium-ion batteries have the watt hour rating marked on the pack.

Regardless of whether a shipment is considered excepted or fully regulated, it is the shipper's responsibility to consult the latest regulations for packaging, labeling/marketing and documentation requirements.

Transporting batteries can possibly cause fire if the battery terminals inadvertently come in contact with conductive materials. When transporting batteries, make sure that the battery terminals are protected and well insulated from materials that could contact them and cause a short circuit.

The information provided in this section of the manual is provided in good faith and believed to be accurate at the time the document was created. However, no warranty, expressed or implied, is given. It is the buyer's responsibility to ensure that its activities comply with the applicable regulations.

Battery Pack

BATTERY TYPE

The DCR020 operates on 10.8 volt, 14.4 volt and 18 volt XR Li-Ion battery packs.

The DCB123, DCB125, DCB127, DCB140, DCB141, DCB142, DCB143, DCB144, DCB180, DCB181, DCB182, DCB183 and DCB184 battery packs may be used. Refer to **Technical Data** for more information.

Storage Recommendations

1. The best storage place is one that is cool and dry away from direct sunlight and excess heat or cold. For optimum battery performance and life, store battery packs at room temperature when not in use.
2. For long storage, it is recommended to store a fully charged battery pack in a cool, dry place out of the charger for optimal results.

NOTE: Battery packs should not be stored completely depleted of charge. The battery pack will need to be recharged before use.

Labels on Charger and Battery Pack

In addition to the pictographs used in this manual, the labels on the charger and the battery pack may show the following pictographs:



Read instruction manual before use.



See **Technical Data** for charging time.



Battery charging.



Battery charged.



Battery defective.



Hot/cold pack delay.



Do not probe with conductive objects.



Do not charge damaged battery packs.



Do not expose to water.



Have defective cords replaced immediately.



Charge only between 4 °C and 40 °C.



Only for indoor use.



Discard the battery pack with due care for the environment.

LI-ION



Charge DEWALT battery packs only with designated DEWALT chargers. Charging battery packs other than the designated DEWALT batteries with a DEWALT charger may make them burst or lead to other dangerous situations.



Do not incinerate the battery pack.

Package Contents

The package contains:

- 1 Radio
- 1 Instruction manual
 - Check for damage to the radio, parts or accessories which may have occurred during transport.
 - Take the time to thoroughly read and understand this manual prior to operation.

Description (fig. 1–4)



WARNING: Never modify the radio or any part of it. Damage or personal injury could result.

- a. Power button
 - b. Volume dial
 - c. Arrow buttons
 - d. Mode button
 - e. Menu button
 - f. Antenna
 - g. Enter/display button
 - h. LCD display
 - i. Battery pack
 - j. Fuel gauge button
 - k. Battery receptacle
 - l. Auxiliary port
 - m. Battery door screw
 - n. Coin cell battery
 - o. Coin cell battery door
 - p. USB port
- **Young children and the infirm.** This appliance is not intended for use by young children or infirm persons without supervision.

Electrical Safety

Always check that the battery pack voltage corresponds to the voltage on the rating plate. Also make sure that the voltage of your charger corresponds to that of your mains.



WARNING: Risk of electric shock. Use in dry locations only.

If the supply cord is damaged, it must be replaced by a specially prepared cord available through the DEWALT service organisation.

Mains Plug Replacement (U.K. & Ireland Only)

If a new mains plug needs to be fitted:

- Safely dispose of the old plug.
- Connect the brown lead to the live terminal in the plug.
- Connect the blue lead to the neutral terminal.



WARNING: No connection is to be made to the earth terminal.

Follow the fitting instructions supplied with good quality plugs. Recommended fuse: 3 A.

Using an Extension Cable

If an extension cable is required, use an approved 3-core extension cable suitable for the power input of this tool (see **Technical Data**). The minimum conductor size is 1.5 mm²; the maximum length is 30 m.

When using a cable reel, always unwind the cable completely.

ASSEMBLY AND ADJUSTMENTS

Inserting a Battery Pack (fig. 4)



WARNING: Use only DEWALT battery packs and chargers.

NOTE: Make sure your battery pack is fully charged. If the battery pack does not produce sufficient power, charge the battery pack following the instructions in the manual of the charger.

NOTE: To ensure maximum performance and life of Li-Ion batteries, charge the battery for a minimum of 10 hours before first use.

To install battery, insert the battery pack (i) into the receptacle until it is fully seated.

FUEL GAUGE BATTERY PACKS (FIG. 4)

Some DEWALT battery packs include a fuel gauge which consists of three green LED lights that indicate the level of charge remaining in the battery pack.

To actuate the fuel gauge, press and hold the fuel gauge button (j). A combination of the three green LED lights will illuminate designating the level of charge left. When the level of charge in the battery is below the usable limit, the fuel gauge will not illuminate and the battery will need to be recharged.

NOTE: The fuel gauge is only an indication of the charge left on the battery pack. It does not indicate tool functionality and is subject to variation based on product components, temperature and end-user application.

To Install the Coin Cell Battery (fig. 2)



WARNING: When replacing battery, replace it with the same brand and type. Observe correct polarity (+ and -) when replacing batteries. Do not store or carry batteries so that metal objects can contact exposed battery terminals.

Your radio is equipped with memory capacity in order to store the time and your selected memory channels. When the radio is OFF, this memory capacity is powered by one coin cell battery that is included with the radio.

1. Turn the radio off and unplug from the power source.
2. Unscrew the screw (m) on the battery door (o).
3. Press down on the battery door latch and pull to open.
4. Install the coin cell battery (n) according to the diagram inside the coin cell battery area.
5. Replace the battery door, insert screw and tighten.

NOTE: To reset the LCD display, clock and presets, remove the coin cell battery and re-install it. Follow this procedure if the screen seems to lock in place.

OPERATION

Instructions for Use



WARNING: Always observe the safety instructions and applicable regulations.



WARNING: Do not place the radio in locations where it may be exposed to dripping or splashing.

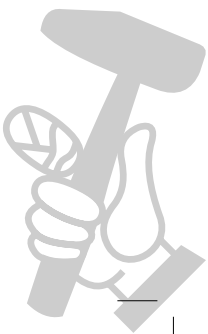

AC Operation

Unwrap power cord and plug into 230 V AC wall outlet.

Operating the Radio (fig. 1)

POWER/VOLUME ADJUSTMENT

1. To turn the radio on, press the power button (a).

NOTE: When the radio is first used it will enter DAB mode and automatically scan for stations. It will then set the time and start playing the first station it finds. If there is no time signal available please refer to **Programming The Clock** to manually set the time.

2. Turn the dial (b) clockwise to increase the volume. To decrease the volume, turn anti-clockwise.

MODE SELECTION

To choose one of the mode functions (DAB, FM, or AUX) push the mode button (d) until the desired function is found. For example, if the radio is on DAB, seen in upper left portion of LCD display (h), push the mode button twice to change to AUX.

DAB MODE - TUNING

When the unit is first switched on in DAB/DAB+ mode the radio will auto scan to find broadcast stations in the local area.

Use the left or right arrow buttons (c) to scroll through the stations.

NOTE: When moving locations or if reception was poor in the original scan (possible if the antenna was not up), this may result in an empty or incomplete list of available stations. Manually running an Auto Scan will find all available broadcast stations.

To Perform an Auto Scan:

1. Press the menu button (e), scroll through the options by pressing the right arrow button (c) until you reach *Auto Scan* and select this option by pressing the Enter/Display button (g).
2. Press the right arrow button to select the Yes option.
3. Press the Enter/Display button (g) to perform the Auto Scan.

Once Auto Scan is complete the radio will play the first station it finds.

To use presets please reference **To Program the Memory Buttons**.

DAB MODE – STATION PRUNE

Some stations once received by your radio which are no longer available may display with a ? after the station name.

To remove these stations from the station list, use the Prune function:

1. Press Menu (e) and scroll right to the *Prune* option.
2. Press Enter/Display (g) to select.

DAB MODE – DYNAMIC RANGE COMPRESSION (DRC)

This function reduces the difference between the loudest and quietest audio being broadcast. Effectively, this makes quiet sounds comparatively louder, and loud sounds comparatively quieter.

The following options are available:

- 0 - broadcast DRC will be ignored
- 1/2 - sets DRC at half the level transmitted
- 1 - uses the DRC level transmitted
- 2 - doubles the DRC level transmitted

NOTE: DRC only works if it is enabled by the broadcaster.

FM MODE – TUNING

To Tune: Push the right arrow to move the tuner up the frequency band, push the left arrow to move the tuner down the frequency band.

To Seek: Press and hold the right arrow button (c) once and release. The tuner frequency will increase to seek the first radio station with acceptable clarity and stop at that station. The right arrow button may be pressed again to continue seeking a radio station at higher frequencies. The left arrow button may be pressed to seek radio stations at lower frequencies. The seek function is available in FM mode.

PROGRAMMING THE CLOCK

The time and date can be updated manually or automatically synchronised with national time signals broadcast over DAB (where available).

To Synchronise the Clock Automatically: (DAB mode ONLY)

NOTE: When the radio is first used it will enter DAB mode and automatically scan for stations.

1. Press the Menu button (e).
2. Use the arrow buttons (c) to scroll to *Clock Adjust* and press the Enter/Display button (g).
3. Scroll to *Sync Time Now* press the Enter/Display button to select. This automatically synchronises clock with national time signals.

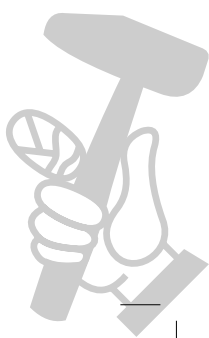

To Adjust the Clock Manually: (FM and DAB mode)

1. Press the Menu button (e).
2. Use the arrow buttons (c) to scroll to *Clock Adjust* on the LCD display and press the Enter/Display button (g).
3. Scroll to *Date & Time* and press the Enter/Display button (g).
4. Set the date and time using left and right arrow buttons (c).
5. Once the desired time is set press the Enter/Display (g) button to commit.

Other Clock Adjust menu options:

- Time format: Select a 12h or 24h time display format
- Date format: Select the date display format, MM/DD/YYYY, YYYY/MM/DD or DD/MM/YYYY.

Important Radio Notes (Fig. 3)

1. The radio will run for up to 14 hours on a fully charged 4.0 amp hour battery in good condition. Using batteries of lower voltage or capacity will result in less run time.
2. Reception will vary depending on location and strength of radio signal.
3. Certain generators may cause background noise.
4. To use the auxiliary port (l), plug the output jack from a CD or iPod®/MP3 player into the port. The sound from the external source plays through the speakers of the radio.
5. The USB power output port (p) is a connection port for powering low power devices such as mobile phones, CD and MP3 players. Note that the radio will not charge via the USB port when powered by batteries.

* iPod is a registered trademark of Apple Inc.

MAINTENANCE

Your DEWALT radio has been designed to operate over a long period of time with a minimum of maintenance. Continuous satisfactory operation depends upon proper care.

Service Notes

This product is not user serviceable. There are no user serviceable parts inside the radio. Servicing at an authorised service centre is required to avoid damage to static sensitive internal components.



Cleaning



WARNING: Never use solvents or other harsh chemicals for cleaning the non-metallic parts of the radio. These chemicals may weaken the materials used in these parts. Use a cloth dampened only with water and mild soap. Never let any liquid get inside the radio; never immerse any part of the radio into a liquid.

CHARGER CLEANING INSTRUCTIONS



WARNING: Shock hazard. Disconnect the charger from the AC outlet before cleaning. Dirt and grease may be removed from the exterior of the radio using a cloth or soft non-metallic brush. Do not use water or any cleaning solutions.

Optional Accessories



WARNING: Since accessories, other than those offered by DEWALT, have not been tested with this product, use of such accessories with this radio could be hazardous. To reduce the risk of injury, only DEWALT recommended accessories should be used with this product.

Consult your dealer for further information on the appropriate accessories.

Protecting the Environment



Separate collection. This product must not be disposed of with normal household waste.

Should you find one day that your DEWALT product needs replacement, or if it is of no further use to you, do not dispose of it with household waste. Make this product available for separate collection.



Separate collection of used products and packaging allows materials to be recycled and used again. Re-use of recycled materials helps prevent environmental pollution and reduces the demand for raw materials.

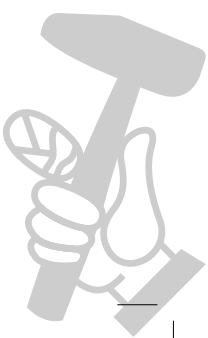

ENGLISH

Local regulations may provide for separate collection of electrical products from the household, at municipal waste sites or by the retailer when you purchase a new product.

DEWALT provides a facility for the collection and recycling of DEWALT products once they have reached the end of their working life. To take advantage of this service please return your product to any authorised repair agent who will collect them on our behalf.

You can check the location of your nearest authorised repair agent by contacting your local DEWALT office at the address indicated in this manual. Alternatively, a list of authorised DEWALT repair agents and full details of our after-sales service and contacts are available on the Internet at: **www.2helpU.com**.



Rechargeable Battery Pack

This long life battery pack must be recharged when it fails to produce sufficient power on jobs which were easily done before. At the end of its technical life, discard it with due care for our environment:

- Run the battery pack down completely, then remove it from the radio.
- Li-Ion cells are recyclable. Take them to your dealer or a local recycling station. The collected battery packs will be recycled or disposed of properly.



GUARANTEE

DEWALT is confident of the quality of its products and offers an outstanding guarantee for professional users of the product. This guarantee statement is in addition to and in no way prejudices your contractual rights as a professional user or your statutory rights as a private non-professional user. The guarantee is valid within the territories of the Member States of the European Union and the European Free Trade Area.

• 30 DAY NO RISK SATISFACTION GUARANTEE •

If you are not completely satisfied with the performance of your DEWALT tool, simply return it within 30 days, complete with all original components, as purchased, to the point of purchase, for a full refund or exchange. The product must have been subject to fair wear and tear and proof of purchase must be produced.

• ONE YEAR FREE SERVICE CONTRACT •

If you need maintenance or service for your DEWALT tool, in the 12 months following purchase, you are entitled to one service free of charge. It will be undertaken free of charge at an authorised DEWALT repair agent. Proof of purchase must be produced. Includes labour. Excludes accessories and spare parts unless failed under warranty.

• ONE YEAR FULL WARRANTY •

If your DEWALT product becomes defective due to faulty materials or workmanship within 12 months from the date of purchase, DEWALT guarantees to replace all defective parts free of charge or – at our discretion – replace the unit free of charge provided that:

- The product has not been misused;
- The product has been subject to fair wear and tear;
- Repairs have not been attempted by unauthorised persons;
- Proof of purchase is produced;
- The product is returned complete with all original components.

If you wish to make a claim, contact your seller or check the location of your nearest authorised DEWALT repair agent in the DEWALT catalogue or contact your DEWALT office at the address indicated in this manual. A list of authorised DEWALT repair agents and full details of our after-sales service is available on the Internet at: **www.2helpU.com**.

