

D	Originalbetriebsanleitung Universalsäge	E	Manual de instrucciones original Sierra universal
GB	Original operating instructions All Purpose Saw	FIN	Alkuperäiskäyttöohje Yleissaha
F	Instructions d'origine Scie universelle	RUS	Оригинальное руководство по эксплуатации Универсальная электропила
I	Istruzioni per l'uso originali Sega universale	SLO	Originalna navodila za uporabo Univerzalna žaga
DK/ N	Original betjeningsvejledning Universalsav	H	Eredeti használati utasítás Univerzálfűrész
S	Original-bruksanvisning Universalsåg	RO	Instrucțiuni de utilizare originale Ferăstrău universal
CZ	Originální návod k obsluze Univerzální pila	GR	Πρωτότυπες Οδηγίες χρήσης Πολυλειτουργικό πριόνι
SK	Originálny návod na obsluhu Univerzálna píla		
NL	Originele handleiding Universele zaag		

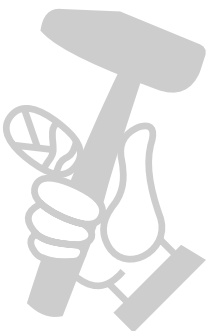

Art.-Nr.: 43.261.61

I.-Nr.: 21011

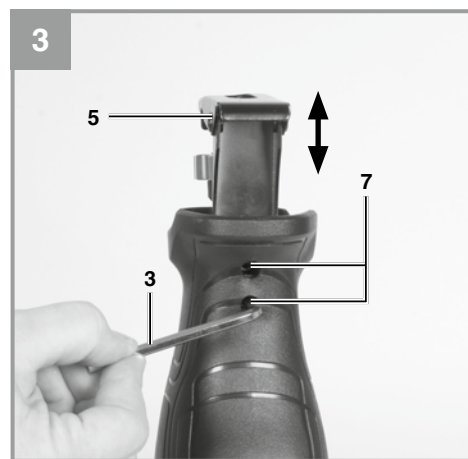
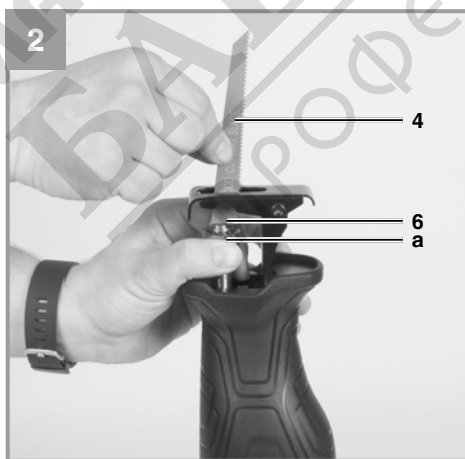
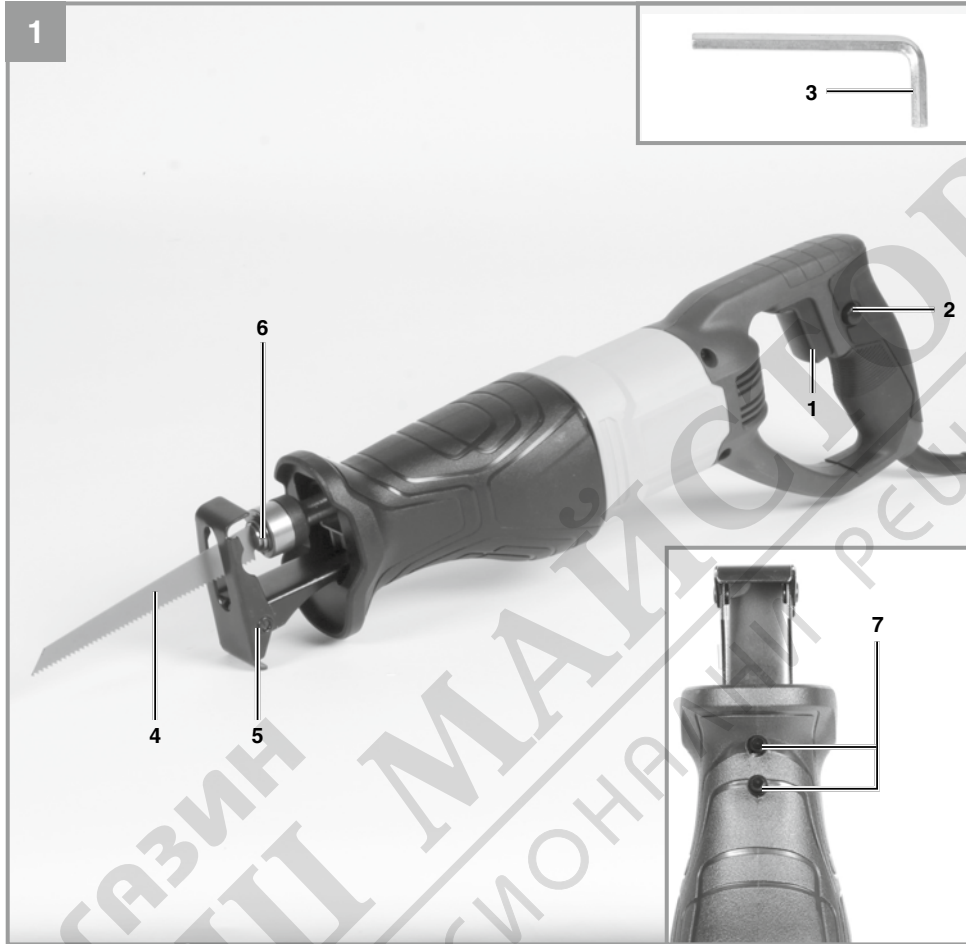



МАГАЗИН МАЙСТОРА®
БАШТАЙН
ПРОФЕСИОНАЛНИ РЕШЕНИЯ

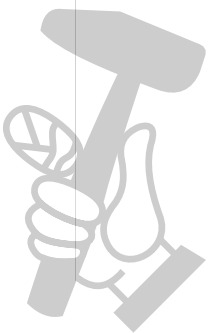



Danger! - Read the operating instructions to reduce the risk of injury



Caution! Wear ear-muffs. The impact of noise can cause damage to hearing.



Caution! Wear a breathing mask. Dust which is injurious to health can be generated when working on wood and other materials. Never use the device to work on any materials containing asbestos!



Caution! Wear safety goggles. Sparks generated during working or splinters, chips and dust emitted by the device can cause loss of sight.

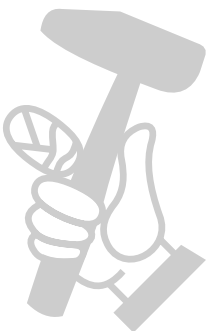

Danger!

When using the equipment, a few safety precautions must be observed to avoid injuries and damage. Please read the complete operating instructions and safety regulations with due care. Keep this manual in a safe place, so that the information is available at all times. If you give the equipment to any other person, hand over these operating instructions and safety regulations as well. We cannot accept any liability for damage or accidents which arise due to a failure to follow these instructions and the safety instructions.

1. Safety regulations

The corresponding safety information can be found in the enclosed booklet.

Warning!

Read all the safety information, instructions, illustrations and technical data provided on or with this power tool. Failure to adhere to the following instructions may result in electric shock, fire and/or serious injury.

Keep all the safety information and instructions in a safe place for future use.

2. Layout and items supplied**2.1 Layout (Fig. 1+3)**

1. ON/OFF switch
2. Locking knob
3. Hexagon key
4. Saw blade
5. Soleplate
6. Blade holder
7. Screws for soleplate

2.2 Items supplied

Please check that the article is complete as specified in the scope of delivery. If parts are missing, please contact our service center or the sales outlet where you made your purchase at the latest within 5 working days after purchasing the product and upon presentation of a valid bill of purchase. Also, refer to the warranty table in the service information at the end of the operating instructions.

- Open the packaging and take out the equipment with care.
- Remove the packaging material and any packaging and/or transportation braces (if available).

- Check to see if all items are supplied.
- Inspect the equipment and accessories for transport damage.
- If possible, please keep the packaging until the end of the guarantee period.

Danger!

The equipment and packaging material are not toys. Do not let children play with plastic bags, foils or small parts. There is a danger of swallowing or suffocating!

- Universal saw
- Saw blade
- Hexagon key
- Original operating instructions
- Safety instructions

3. Proper use

The multi-saw is designed for sawing wood, iron, non-ferrous metals and plastic. It should only be used with the appropriate saw blade.

The equipment is to be used only for its prescribed purpose. Any other use is deemed to be a case of misuse. The user / operator and not the manufacturer will be liable for any damage or injuries of any kind caused as a result of this.

Please note that our equipment has not been designed for use in commercial, trade or industrial applications. Our warranty will be voided if the machine is used in commercial, trade or industrial businesses or for equivalent purposes.

4. Technical data

Mains voltage:220-240 V~ 50 Hz
 Power: 690 W
 Stroke rate:0-2800 min⁻¹
 Stroke height: 20 mm
 Cutting depth in wood: 115 mm
 Cutting depth in iron: 10 mm
 Saw blade width: 0.8 - 1.5 mm
 Protection class: II/□
 Weight:2.2 kg

Danger!**Sound and vibration**

Sound and vibration values were measured in accordance with EN 62841.

L_{pA} sound pressure level	85.53 dB(A)
K_{pA} uncertainty	5 dB
L_{WA} sound power level	96.53 dB(A)
K_{WA} uncertainty	5 dB

Wear ear-muffs.

The impact of noise can cause damage to hearing.

Total vibration values (vector sum of three directions) determined in accordance with EN 62841.

Cutting wooden boards (front handle)

Vibration emission value $a_h = 23.448 \text{ m/s}^2$
Uncertainty $K = 1.5 \text{ m/s}^2$

Cutting wooden boards (rear handle)

Vibration emission value $a_h = 18.195 \text{ m/s}^2$
Uncertainty $K = 1.5 \text{ m/s}^2$

Cutting wooden beams (front handle)

Vibration emission value $a_h = 22.344 \text{ m/s}^2$
Uncertainty $K = 1.5 \text{ m/s}^2$

Cutting wooden beams (rear handle)

Vibration emission value $a_h = 16.039 \text{ m/s}^2$
Uncertainty $K = 1.5 \text{ m/s}^2$

The specified vibration value was established in accordance with a standardized testing method. It may change according to how the electric equipment is used and may exceed the specified value in exceptional circumstances.

The specified vibration value can be used to compare the equipment with other electric power tools.

The specified vibration value can be used for initial assessment of a harmful effect.

Keep the noise emissions and vibrations to a minimum.

- Only use appliances which are in perfect working order.
- Service and clean the appliance regularly.
- Adapt your working style to suit the appliance.
- Do not overload the appliance.
- Have the appliance serviced whenever necessary.

- Switch the appliance off when it is not in use.
- Wear protective gloves.

Caution!**Residual risks**

Even if you use this electric power tool in accordance with instructions, certain residual risks cannot be ruled out. The following hazards may arise in connection with the equipment's construction and layout:

1. Lung damage if no suitable protective dust mask is used.
2. Damage to hearing if no suitable ear protection is used.
3. Health damage caused by hand-arm vibrations if the equipment is used over a prolonged period or is not properly guided and maintained.

5. Before starting the equipment

Before you connect the equipment to the mains supply make sure that the data on the rating plate are identical to the mains data.

Warning!

Always pull the power plug before making adjustments to the equipment.

5.1 Changing the saw blade (Fig. 2)

Always switch off and unplug the multi-saw before working on the machine or changing the saw blade.

Turn the ring (a) on the blade holder (6) as shown in Fig. 2 until the blade (4) lets itself be slipped into the slot of the blade holder (6). Then allow the ring (a) to slide back again.

Now pull on the blade to check whether it is tightly seated in the holder.

5.2 Adjusting the soleplate (Fig. 3)**Warning!**

Pull out the power plug.

To adjust the soleplate, undo the two screws (7) using the supplied hexagon key (3). Set the required distance and retighten the two screws (7). Check that the soleplate is secure.

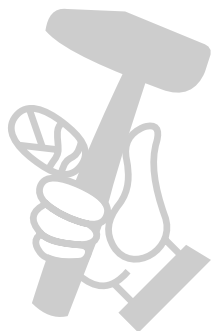

6. Operation

6.1 ON/OFF switch (Fig. 1/Item 1)

To switch on:

Press the ON/OFF switch

Infinitely variable stroke speed control is possible with the On/Off switch (1). The further you push the switch, the higher the stroke speed.

To switch off:

Release the ON/OFF switch

6.2 Locking button (Fig. 1/Item 2)

You can lock the ON/OFF switch (1) using the locking button (2) when the equipment is in operation. To switch off the equipment briefly hold down the ON/OFF switch (1).

6.3 Use as a jigsaw (Fig. 4)

Place the multi-saw on the material to be cut as shown in Fig. 4. Switch on the multi-saw and push it along against the material to be cut. Adapt your cutting speed to the material.

cleaning agents or solvents; these could attack the plastic parts of the equipment. Ensure that no water can seep into the device. The ingress of water into an electric tool increases the risk of an electric shock.

8.2 Carbon brushes

In case of excessive sparking, have the carbon brushes checked only by a qualified electrician.

Danger! The carbon brushes should not be replaced by anyone but a qualified electrician.

8.3 Maintenance

There are no parts inside the equipment which require additional maintenance.

8.4 Ordering spare parts and accessories

Please provide the following information when ordering spare parts:

- Type of unit
- Article number of the unit
- ID number of the unit
- Spare part number of the required spare part

For our latest prices and information please go to www.Einhell-Service.com

7. Replacing the power cable

Danger!

If the power cable for this equipment is damaged, it must be replaced by the manufacturer or its after-sales service or similarly trained personnel to avoid danger.

8. Cleaning, maintenance and ordering of spare parts

Danger!

Always pull out the mains power plug before starting any cleaning work.

8.1 Cleaning

- Keep all safety devices, air vents and the motor housing free of dirt and dust as far as possible. Wipe the equipment with a clean cloth or blow it with compressed air at low pressure.
- We recommend that you clean the device immediately each time you have finished using it.
- Clean the equipment regularly with a moist cloth and some soft soap. Do not use

9. Disposal and recycling

The equipment is supplied in packaging to prevent it from being damaged in transit. The raw materials in this packaging can be reused or recycled. The equipment and its accessories are made of various types of material, such as metal and plastic. Never place defective equipment in your household refuse. The equipment should be taken to a suitable collection center for proper disposal. If you do not know the whereabouts of such a collection point, you should ask in your local council offices.

10. Storage

Store the equipment and accessories in a dark and dry place at above freezing temperature. The ideal storage temperature is between 5 and 30 °C. Store the electric tool in its original packaging.



For EU countries only

Never place any electric power tools in your household refuse.

To comply with European Directive 2012/19/EC concerning old electric and electronic equipment and its implementation in national laws, old electric power tools have to be separated from other waste and disposed of in an environment-friendly fashion, e.g. by taking to a recycling depot.

Recycling alternative to the return request:

As an alternative to returning the equipment to the manufacturer, the owner of the electrical equipment must make sure that the equipment is properly disposed of if he no longer wants to keep the equipment. The old equipment can be returned to a suitable collection point that will dispose of the equipment in accordance with the national recycling and waste disposal regulations. This does not apply to any accessories or aids without electrical components supplied with the old equipment.

Please note that batteries and lamps (e.g. light bulbs) must be removed from the tool before it is disposed of.

The reprinting or reproduction by any other means, in whole or in part, of documentation and papers accompanying products is permitted only with the express consent of the Einhell Germany AG.

Subject to technical changes

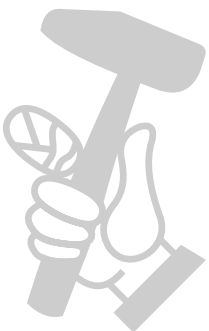

Service information

We have competent service partners in all countries named on the guarantee certificate whose contact details can also be found on the guarantee certificate. These partners will help you with all service requests such as repairs, spare and wearing part orders or the purchase of consumables.

Please note that the following parts of this product are subject to normal or natural wear and that the following parts are therefore also required for use as consumables.

Category	Example
Wear parts*	Carbon brushes
Consumables*	Saw blade
Missing parts	

* Not necessarily included in the scope of delivery!

In the effect of defects or faults, please register the problem on the internet at www.Einhell-Service.com. Please ensure that you provide a precise description of the problem and answer the following questions in all cases:

- Did the equipment work at all or was it defective from the beginning?
- Did you notice anything (symptom or defect) prior to the failure?
- What malfunction does the equipment have in your opinion (main symptom)? Describe this malfunction.

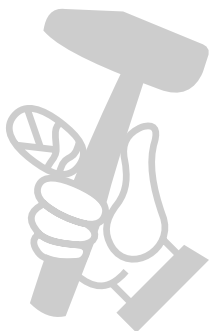

Warranty certificate

Dear Customer,

All of our products undergo strict quality checks to ensure that they reach you in perfect condition. In the unlikely event that this equipment develops a fault, please contact our service department at the address shown on this guarantee card. You can also contact us by telephone using the service number shown. Please note the following terms under which guarantee claims can be made:

1. These guarantee terms apply solely to consumers, i.e. natural persons, who do not want to use this product in connection with either their commercial or other self-employed activities. These guarantee terms regulate additional guarantee services which the undermentioned manufacturer promises to buyers of its new products in addition to their statutory rights of guarantee. Your statutory rights of guarantee are not affected by this guarantee. Our guarantee is free of charge to you.
2. The guarantee services cover only defects due to material or manufacturing faults on the new product which you have bought in the European Union from the undermentioned manufacturer and are limited to either the rectification of said defects or the replacement of the product, whichever we prefer. Please note that only equipment under the brand name "Professional" has been designed for use in commercial, trade or professional applications. For all other products the guarantee is invalidated if the equipment is used within the guarantee period in commercial, trade or industrial applications or for other equivalent activities.
3. Our guarantee does not cover:
 - Damage to the equipment caused by failure to comply with the installation/assembly instructions or by unprofessional installation; damage caused by failure to comply with the operating instructions (e.g. connection to the wrong mains voltage or current type); damage caused by failure to comply with the maintenance and safety regulations; damage caused by exposing the equipment to abnormal environmental conditions; damage resulting from poor care and maintenance.
 - Damage to the equipment caused by misuse or incorrect applications (e.g. overloading the equipment or using non-approved attachments or accessories); damage caused by foreign bodies (e.g. sand, stones, dust, ...) getting inside the equipment. Damage in transit; damage caused by force or external influences (e.g. by dropping the equipment).
 - Damage to the equipment or parts of the equipment which is owed to use-related, normal or otherwise natural wear. For example, batteries and battery packs are manufactured with a cycle limit for design-related reasons. Wear is negatively influenced in particular by load demands and charging speeds as well as exposure to heat, cold, vibration and impact.
4. The guarantee is valid for a period of 2 years starting from the purchase date of the equipment. Guarantee claims must be submitted before the end of the guarantee period and within two weeks of the defect being noticed. No guarantee claims will be accepted after the end of the guarantee period. The original guarantee period remains applicable to the equipment even if repairs are carried out or parts are replaced. In such cases, the work performed or parts fitted will not result in an extension of the guarantee period, and no new guarantee will become active for the work performed or for any replacement parts fitted. This also applies if on-site service is used.
5. To assert your guarantee claim, register the defective equipment at: www.Einhell-Service.com. You will need to provide proof of purchase of the new item of equipment. Equipment returned without such proof or without a rating plate are excluded from the guarantee services because of the lack of traceability. If the defect is covered by our guarantee, then either the item in question will be repaired immediately and returned to you or we will send you a new replacement.
6. If you have taken the equipment with you to a different EU country than where you bought it, we will arrange for a local service partner to provide the guarantee services. If you take the equipment outside the EU, the guarantee will not apply.

Of course, we are also happy to offer a chargeable repair service for any defects which are not covered or no longer covered by the scope of this guarantee. To take advantage of this service, please send the equipment to our service address. We draw attention to the restrictions of this guarantee concerning wear parts, consumables and missing parts as presented in the service information included in this operating manual.

Warrantor/ Service:

Einhell UK Ltd, Unit 10, 1st Floor, Champion's Business Park, Arroe Brook Road, Upton, Wirral, CH49 0UQ