

EN

HONDA

Owner's Manual

Original Instructions



Robotic Lawnmower

HRM1000/
1500/1500 Live/
2500/2500 Live



MiiMo

Service & Support

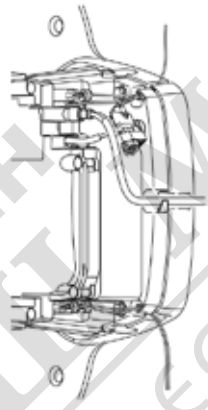
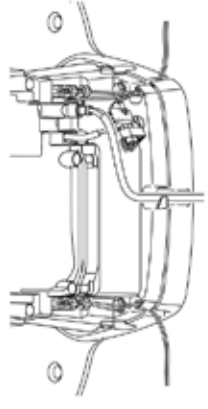
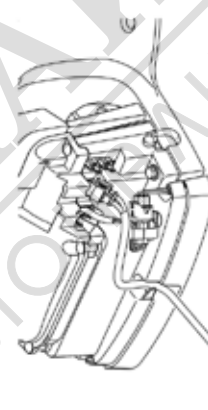
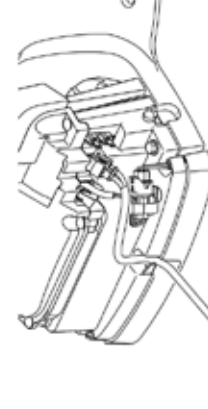
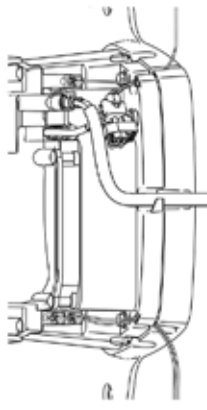
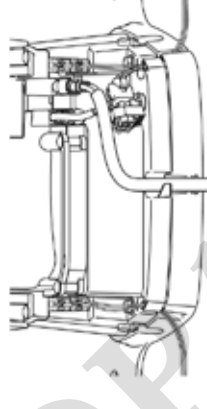


<https://www.hondapps.com/HME/>

Please refer to "5.Mii-monitor Preparation" how to install the Mii-monitor with mobile network (HRM1500 Live, HRM2500 Live) and Bluetooth® connectivity.



Some elements in the Owner's Manual have changed, please refer to the table below:

Model	HRM2500	HRM4000
Reference of the original Owner's Manual	00X32-VP7-7000	00X32-VP9-7000
Modification	<p>Page 28</p> 	<p>Page 22</p> 
	<p>Page 85</p> 	<p>Page 77</p> 
	<p>Page 111</p> 	<p>Page 96</p> 



3RVPA600
00X3R-VPA-6000



BAC DE TRI



FR
A DÉPOSER
EN MAGASIN
OU
A DÉPOSER
EN DÉCHÈTERIE



Points de collecte sur www.quefaire.com/echosets.fr

Specifications: Additional Technical Data to the Owner's Manual

Model / type	HRM1000 E/B/S	HRM1500 E/B/S	HRM1500 Live EC/BC/SC	HRM2500 E/B/S	HRM2500 Live EC/BC/SC	HRM4000 EC/BC/SC
--------------	------------------	------------------	-----------------------------	------------------	-----------------------------	---------------------

Frequency Band Support

Bluetooth	✓	✓	✓	✓	✓	✓
TCU 3G UMTS	Classic: 4.2+ERD/LE:4.2			✓	✓	✓
	Band 8 (900 MHz)				✓	✓
	Band 1 (2100 MHz)				✓	✓
	Band 3 (1800 MHz)				✓	✓
	Band 7 (2600 MHz)				✓	✓
TCU 4G LTE FDD/TDD	Band 8 (900 MHz)		✓		✓	✓
	Band 20 (800 MHz)				✓	✓
	Band 28 (700 MHz)				✓	✓
	Band 38 (2600 MHz)				✓	✓
TCU GNSS	GPS/QZSS: L1C/A, L5C BDS: B1I, B2a GLONASS: L1OF Galileo: E1, E5a		✓		✓	✓

Output power

Bluetooth	10 dBm	✓	✓	✓	✓	✓
TCU 3G UMTS	Power class 3				✓	✓
	24 dBm					
TCU 4G LTE FDD/TDD	Power class 3			✓	✓	✓
	23 dBm					

Congratulations on your selection of a Honda Robotic Lawnmower. We are confident that you will enjoy the benefit of your Honda Robotic Lawnmower as we take great pride in creating the finest quality lawn care products.

We want to help you get the best results from your new robotic lawnmower and to operate it safely. This manual contains all the information on how to do that; please read it carefully.

Your servicing dealer is dedicated to your satisfaction and will be pleased to answer your questions and concerns.

Honda Motor Co., Ltd. reserves the right to make changes at anytime without notice and without incurring any obligation.

No part of this publication may be reproduced without written permission.

This manual should be considered a permanent part of the robotic lawnmower and should remain with it if it is resold.

Pay special attention to statements preceded by the following words;

▲ WARNING

Indicates a high risk of severe personal injury or death if instructions are not followed.

▲ CAUTION

Indicates a possibility of personal injury or equipment damage if instructions are not followed.

NOTE:

Gives helpful information.

If a problem should arise, or if you have any questions about the robotic lawnmower, consult an authorised Honda dealer.

Honda robotic lawnmowers are designed to give safe and dependable service if operated according to instructions.

▲ WARNING

Operating a robotic lawnmower requires special attention to ensure the safety of the operator and the safety of others. Read and understand this Owner's Manual before operating the robotic lawnmower; failure to do so could result in personal injury or equipment damage.

How to identify your machine

The model of your robotic lawnmower is indicated on its "Identification label" by a series of letters.

Category	Series	Type
HRM	1000/	EC
	1500/	— E/EC = AC 230 V - EU plug
	2500	— B/BC = AC 240 V - UK plug
		— S/SC = AC 230 V - SW plug
		— Robotic lawnmower

* The illustrations may vary according to the type

Make sure to have your dealer fill in "LAWN DIAGRAM" (page 124) and "DEALER CHECKSHEET" (page 128) with details on the installation it has performed and the settings it has configured.

- Apple, the Apple logo, and iPhone are trademarks of Apple Inc., registered in the U.S. and other countries. App Store is a service mark of Apple Inc.
- Google Play, the Google Play logo, and Android are trademarks or registered trademarks of Google Inc.
- "QR Code" is registered trademark of DENSO WAVE INCORPORATED.
- Alexa and all related logos are trademarks of Amazon.com, Inc. or its affiliates.
- The *Bluetooth*® word mark and logos are registered trademark owned by Bluetooth SIG, Inc. and any use of such marks by Honda Motor Co., Ltd. is under license. Other trademarks and trade names are those of their respective owners.

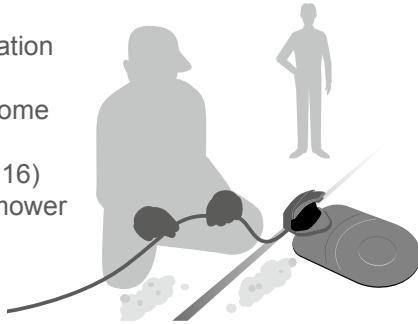
CONTENTS

Setting

Safety Instructions

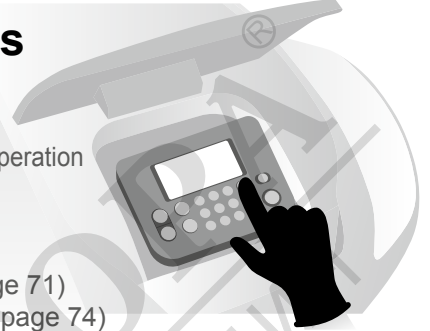
Preparation

- Component identification (☞ page 11)
- Control panel and Home screen (☞ page 13)
- Installation (☞ page 16)
- Setting up the lawnmower (☞ page 29)



Menu Settings

- Setting the work timer (☞ page 46)
- Setting the lawnmower operation (☞ page 52)
- Checking the system (☞ page 68)
- Viewing history (☞ page 71)
- Setting the system (☞ page 74)



Mii-monitor Preparation

(☞ page 79)

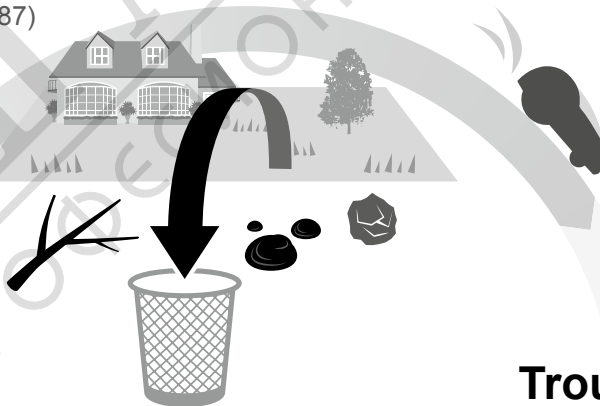


Operation

Usage

- Checking the mowing area (☞ page 84)
- Checking the lawnmower (☞ page 86)
- Turning on / off the power (☞ page 87)
- Operating the lawnmower in the Auto mode (☞ page 89)
- Operating the lawnmower in the Manual mode (☞ page 90)
- Adjusting the height of the blades (☞ page 93)

- Weekly checks (☞ page 94)
- Carrying the lawnmower (☞ page 95)



Troubleshooting

(☞ page 97)

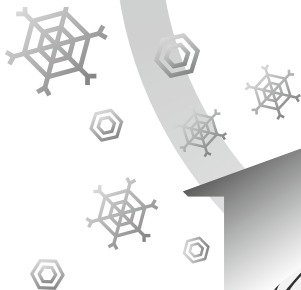
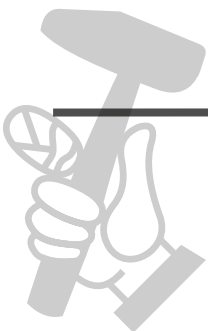
Periodical Usage

Maintenance

- Periodic inspection and maintenance (☞ page 102)
- Maintenance procedures (☞ page 103)

Storage

(☞ page 115)



1 OVERVIEW	4
How the Honda Robotic Lawnmower works.....	4
2 SAFETY INSTRUCTIONS	6
Precautions	6
Label locations	10
Observe the following points for your safety	8
3 PREPARATION	11
Component identification.....	11
Installation	16
Control panel and Home screen.....	13
Setting up the lawnmower	29
4 MENU SETTINGS	44
Menu overview	44
Setting the work timer	46
• Work timer.....	46
• Seasonal timer.....	49
Setting the lawnmower operation.....	52
• Mowing setup.....	52
• Homing setup.....	65
Checking the system.....	68
• Check signal	68
Viewing history	71
• Operation history	71
• Fault history	73
Setting the system.....	74
• Language.....	74
• Date and Time	75
• Reset	78
• Start points	47
• Quiet timer.....	51
• Garden layout.....	63
• Test start points	69
• Work history	72
• Display/Sound.....	74
• Security	76
• Help	78
5 Mii-monitor Preparation	79
About Mii-monitor	79
Registering a user	80
Menu display after connecting to a device	83
Installing Mii-monitor	79
Pairing a device (connecting via <i>Bluetooth</i> [®]).....	81
6 USAGE	84
Checking the mowing area.....	84
Checking the lawnmower.....	86
Operating the lawnmower in the Auto mode.....	89
Adjusting the height of the blades	93
Carrying the lawnmower	95
Connecting to a power source.....	84
Turning on / off the power	87
Operating the lawnmower in the Manual mode.....	90
Weekly checks.....	94
7 TROUBLESHOOTING	97
Before contacting your dealer	97
Resolving problems.....	100
Messages	98
8 MAINTENANCE	102
Periodic inspection and maintenance	102
Maintenance procedures	103
9 STORAGE	115
Winter Storage	115
Get your lawnmower ready for the new season	115
10 TECHNICAL INFORMATION	116
Specifications	116
11 APPENDIX	118
Major Honda Distributor Addresses	118
“UK Declaration of Conformity”	
CONTENT OUTLINE	119
“EC Declaration of Conformity”	
CONTENT OUTLINE.....	120
LCD MENU INDEX	123
LAWN DIAGRAM	124
DEALER CHECKSHEET	128
QUICK GUIDE	130

1 OVERVIEW

How the Honda Robotic Lawnmower works

The mowing area is determined by the boundary wire that emits a signal; when the lawnmower detects the boundary it turns and it cuts the grass randomly. When battery starts running out, it goes back to the docking station.

If Mii-monitor is installed on a smartphone connected to mobile network, you can configure settings and check error notifications from any remote location (HRM1500 Live, HRM2500 Live).

AC adapter

The AC adapter must be installed in a shaded area protected from rain. Install and fix the AC adapter on the wall at a minimum height of 30cm from the ground. Connect the AC adapter to the power supply after all connections are completed.

Docking station

The docking station should be placed on level ground, and the height difference between the front and back of the docking station should not exceed 5°. For details, see "Installation" (☞ page 16).

There are various ways to install the docking station. For details, see "Checking conditions for installation" (☞ page 16).

Shortcut wire (HRM1500, HRM1500 Live, HRM2500, HRM2500 Live only)

The Shortcut wires are laid in the ground or fixed to the ground with wire pegs. Lay the shortcut wire at a bending angle of 90° or more.

Power cord

Robotic Lawnmower

Boundary wire

Lay the boundary wire by burying it under the ground, or securing it on the ground with pegs.

Maximum area:

1000 m² (HRM1000)

1500 m² (HRM1500, HRM1500 Live)

3000 m² (HRM2500, HRM2500 Live)

Maximum possible length:

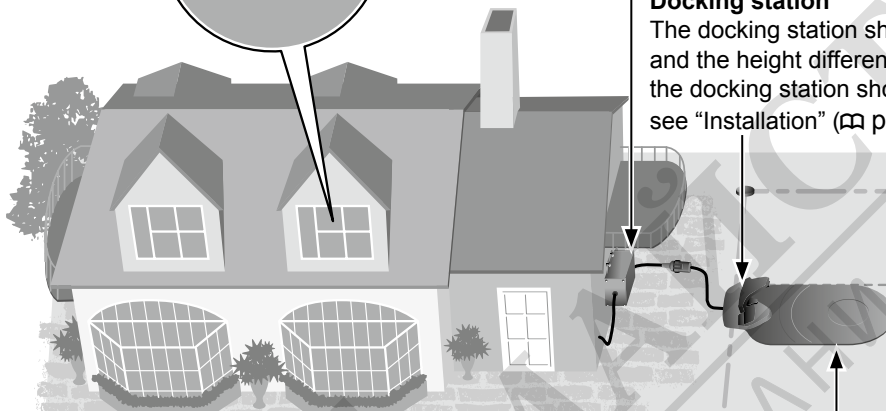
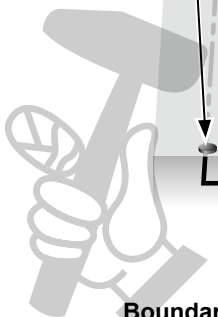
400 m (HRM1000, HRM1500, HRM1500 Live)

800 m (HRM2500, HRM2500 Live)

Free zone (HRM1500 Live, HRM2500 Live only)

Use GPS to set areas where you want to reduce the frequency of the lawnmower intrusion (for planned activities or if the user requires an area to continue to grow).

For details, see "GNSS" (☞ page 61).



Pegs

● Laying boundary wire

The boundary wire location determines the parameters of the mowing area, this area may consist of multiple sections in which the lawnmower can operate. For mowing start point setup and detailed information please see “4 MENU SETTINGS” (☞ page 44).

Laying the boundary wire where the slope is too steep has a bad effect on the lawnmower. For more information, see “Conditions for laying the boundary wire” (☞ page 24).

The advantage of laying the shortcut wire is that it shortens the traveling distance between the docking station and the mowing start points, and suppresses the occurrence of wheel tracks.

- Shortens the returning time to the docking station.
- Facilitates traveling through the narrow passages.

Do not lay the boundary wire laterally across a slope that is steeper than 10°(17%).

Lay the boundary wire laterally across a relatively flat space, with a slope of less than 10°(17%), that comes after the location where the slope is more than 10°(17%).

Correct

Less than 10° (17%)

Incorrect

More than 10° (17%)

Leave 5 mm of space or less between parts of the boundary wire and make sure that parts of the boundary wire do not overlap or cross.

Leave 30 cm to 50 cm of space between the boundary wire and the mowing area boundary.

Lay the boundary wire around the objects which the lawnmower might run on top of (e.g. rocks, tree roots, etc.); these objects must be removed from the work area.

The shortcut wire can be laid on slopes of less than 10°(17%). If the shortcut wire is laid on a slope of less than 10°(17%), lay it obliquely to the slope.

NOTE:

- Make sure to fill in “LAWN DIAGRAM” referring to the layout of the boundary wire (☞ page 124).

2 SAFETY INSTRUCTIONS

Precautions

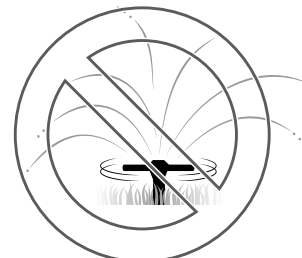
Carefully observe the following precautions.

▲ WARNING

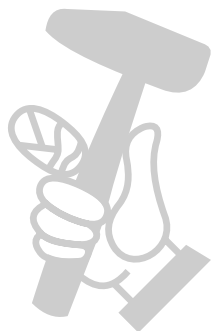
- Never allow children, persons with reduced physical, sensory or mental capabilities or lack of experience and knowledge or people unfamiliar with this owner's manual to use the lawnmower. Local regulations may restrict the age of the operator.
- Before using the robotic lawnmower or entering the work area, persons using a pacemaker or other medical device should consult a doctor.
- Do not play with or near the lawnmower when it is in operation.
 - Inadvertent contact with the mowing blade may cause injury.
- Never use the lawnmower in the immediate vicinity of people, especially children or animals. (Make sure that there are no children or small animals (e.g. hedgehogs) in the work area while using the work timer program.)

▲ CAUTION

- Before operating the lawnmower, read and understand the Owner's Manual to become familiar with the operation of the lawnmower, and learn how to stop immediately.
- The lawnmower's STOP button (red) on the top turns off all its functions. The control panel cover opens, when the STOP button is pressed, and the STOP button remains pressed until the cover is closed again.
- Make sure to keep your hands, feet and any other body parts away from the rotating blades.
- Do not touch sharp components such as the blades or blade disc other than when performing maintenance. If you do, you may be injured.
- Always press the manual STOP button first before you physically interact with the lawnmower such as lifting, turning sideways or upside down. If you do not, you may come in contact with the blades and become injured.
- If an error message is displayed, stop the lawnmower immediately and contact the store where you purchased the lawnmower or a designated service shop.
- Keep in mind that the operator or user is responsible for accidents or hazards occurring to other people or their property.
- Wear long pants and sturdy shoes when nearby or inside the work area while the lawnmower is operating.
- Do not ride on the lawnmower and the docking station, push the lawnmower, or use it for anything other than its intended purpose. An accident may occur or the lawnmower may be damaged.
- Carry out your mowing operation only within the boundary wire area.
- If there is a risk of the lawnmower damaged by contacting a sprinkler, move the sprinkler while the lawnmower is operating, or lay boundary wire around the sprinkler to remove it from the work area.
- Do not use automatic lawn watering systems while the lawnmower is operating, because the watering equipment may become damaged and the likelihood of water penetrating into the lawnmower is greatly increased. Adjust the work timer of the lawnmower so the watering systems and the lawnmower do not operate at the same time.
- Although it is possible to mow the lawn even in the rain, working with wet grass may reduce work performance and efficiency.
- If there is a risk of adverse weather such as lightning or a storm, stop operation and disconnect the power cord.



- If lightning is imminent, remove the lawnmower from the docking station, unplug from the electrical outlet, and disconnect the boundary wire from the docking station.
- Parts of this product may become warm in direct sunlight. Make sure you do not touch these parts if they become extremely hot or you may burn yourself.
- Do not charge the lawnmower with anything other than the docking station. An accident may occur or the lawnmower may be damaged.
- If the power supply cord is damaged, immediately unplug it from the outlet and contact your dealer. Also, do not touch the damaged part of the power supply cord.
- If there are any holes (such as rabbit holes, etc.) in the work area, fill them in so that the work area is level. Periodically check the work area for holes.
- Operation is not guaranteed if this unit is used together with devices that transmit radio waves, such as remote controls and wireless transmitters.
- Despite the adoption of inherent safety design measures, safeguard measures and supplementary protective measures, there is a risk of unexpected injury or electric shock. Handle with care.
- For machines used in public areas, warning signs must be placed around the working area of the machine. The signs must include the following texts:
Warning! Robotic lawnmower! Keep away from the machine! Supervise children!



МАГАЗИН МАЙСТОР
БАШ МАЙСТОР®
ПРОФЕСИОНАЛНИ РЕШЕНИЯ

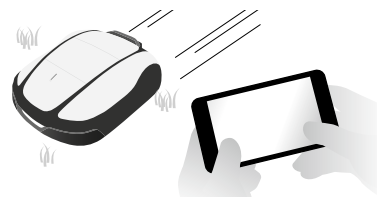
Observe the following points for your safety

⚠ WARNING

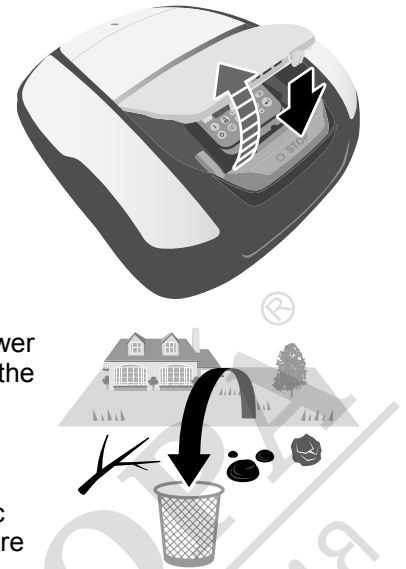
- Do not puncture, crush, short circuit the battery.
- Under normal conditions of use, the electrode materials and the electrolyte they contain are hermetically sealed, provided that the integrity of the battery is preserved and the solder remains intact.
- In case of opening of the vents or rupture of the containers, it can lead to an electrolyte leak.
- If inhaled, ventilate, rest and stay warm.
- In case of contact with the eyes, irrigate abundantly with water for at least 15 minutes.
- If swallowed, wash your mouth thoroughly and drink plenty.
- All the power circuits must be disconnected :
 - Before accessing to the terminals.
 - After hitting a foreign object to examine the damage to the machine.
 - In the event of accident.
 - Before any intervention on the machine.
 - Before adjusting the cutting height.
- Do not touch the exposed tip of a boundary wire that has been cut or damaged. You may be injured or electrocute yourself.
- If the power supply cord or plug is damaged, immediately unplug it from the outlet without touching the damaged part, dispose the AC adapter and then contact your dealer.
- Naked flame sources, such as candles, must not be placed on the AC adapter.
- Do not touch the charging socket. If you touch it, you may become injured.
- Observe the following points when touching the power outlet (House), power cord, and AC adapter. If you do not, you may be electrocuted.
 - Do not touch the power outlet (House), cord, and AC adapter with wet hands.
 - Do not touch the power outlet (House), cord, and AC adapter if the power outlet (House), power cord, or AC adapter is wet.
- Perform periodic checks to confirm that no dust, dirt, or other things have gathered in or on the power outlet (House), power cord, or AC adapter. If such things are present, remove them or they may cause a fire.
- When connecting the plug, hold the plug by its designated grip area. Failure to hold the plug correctly may result in electrocution if you touch the connector area.
- Never attempt to tamper with the lawnmower. It can cause an accident as well as damage to the lawnmower.

⚠ CAUTION

- When carrying the lawnmower, turn it off and carry it as explained in this manual (see [page 95](#)) with the blades facing away from you.
- When carrying the lawnmower, make sure to carry it by the designated areas (see [page 95](#)). If you carry the lawnmower in any other way, you risk injury from the blades or charging socket of the lawnmower. You may also drop and damage the lawnmower.
- When using the remote control feature of the lawnmower application "Mii-monitor", follow the precautions below.
 - Operate in a brightly-lit area
 - Avoid operating on wet grass
 - Thoroughly watch your footing on inclines
- Always maintain balance to avoid staggering due to overextension of the body, always walk on a slope with a clear footing, and never run while operating the machine or its peripheral equipment.
- Always use thick work gloves when performing maintenance. If you do not, you may be injured by the blades.



- Always press the manual STOP button first before you physically interact with the lawnmower. If you do not, you may become injured, prevent the lawnmower from connecting to the docking station, or stop the lawnmower's operation.
 - When performing maintenance on the lawnmower, make sure to press the manual STOP button and stop the lawnmower from moving. If the lawnmower is moving, an accident may occur.
 - In case of person injury, all the power circuits must be disconnected. Call local emergency medical services.
 - Before operation, always check the work area and remove any branches, rocks, and other objects that can damage the blades and cause the lawnmower to stop. If you do not, you may be injured from objects that are ejected from the bottom of the lawnmower, or the lawnmower may become damaged.
 - Do not operate the lawnmower on dirt or gravel. Foreign matter may fly out and the cutting blade may be damaged.
 - Lay the boundary wire so that it is held firmly in place, and perform periodic checks after laying it to ensure that it has not slackened. If the boundary wire protrudes from the ground, you or someone else may trip on it and fall.
 - To prevent the lawnmower from falling, divide the work area with a fence or something similar if it is close to a pond, cliff, etc. The height must be at least 15cm.
 - When connecting with the boundary wire, use the supplied connector.
 - After confirming that all wires are connected to the docking station, connect the AC adapter to an outlet.
 - Install the AC adapter in a place that is out of direct sunlight and does not get wet even in the rain.
- IP55 is applicable to the adaptor body except plug part. The plug part must be placed beneath the canopy. When outdoor use, plug part must be inserted into a waterproof socket.



IP degree of Plug:

ADP-60MR AAC ... IP44 for plug part

ADP-60MR AAD ... IP20 for plug part

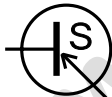
ADP-60MR BAS ... IP55 for plug part



Protection class II appliance (except ADP-60MR BAS)



non-inherently Short-circuit-proof safety isolating AC adapter



Switch mode power supply unit

- Wear gloves when touching the AC adapter because it becomes hot when it is plugged into a power outlet (house).
- The AC adapter and the mains-socket must all times be easily accessible.
- In case of broken cords or plugs the AC adapter must be disposed.
- The AC adapter should be treated with caution. If you want to clean it, please use only dry cloths or brush.
- Use this AC adapter by children shall be under the full supervision of parents.
- When extending the cord on the output side of the AC adapter, use an extension cord specified by Honda.
- Make sure that the contents of "SAFETY INSTRUCTIONS" are absolutely clear to persons who may come in contact with the robotic lawnmower. If you do not, an accident may occur.
- People who are not thoroughly familiar with this Owner's Manual should not come into contact with the lawnmower other than to stop it.
- When approaching the operating lawnmower, pay attention to materials that may be scattered by the blades.
- Do not use the lawnmower if the outer casing is damaged.
The blade may accidentally cut you or you may be injured by debris thrown off by the blade.

Disposal

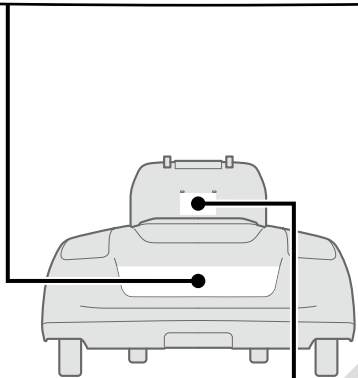
To protect the environment, do not dispose of this product, battery, etc. carelessly by leaving them in the waste.


Observe the local laws and regulations or consult your authorised Honda dealer for disposal.

Label locations


● POSITIONING OF SAFETY LABELS


Your lawnmower should be used with due care and attention. Therefore, figured labels have been placed on various parts of the machine to remind you of the main precautions to be taken. Their full meaning is explained later on. These labels are an integral part of the lawnmower and so, if any of them should become detached or illegible, contact your servicing dealer for their replacement. You are also asked to carefully read the safety regulations in the applicable chapter of this handbook.



 The Honda Robotic Lawnmower is designed to give safe and dependable service if operated according to instructions. Read and understand the Owner's Manual before operating the Honda Robotic Lawnmower. Failure to do so could result in personal injury or equipment damage.

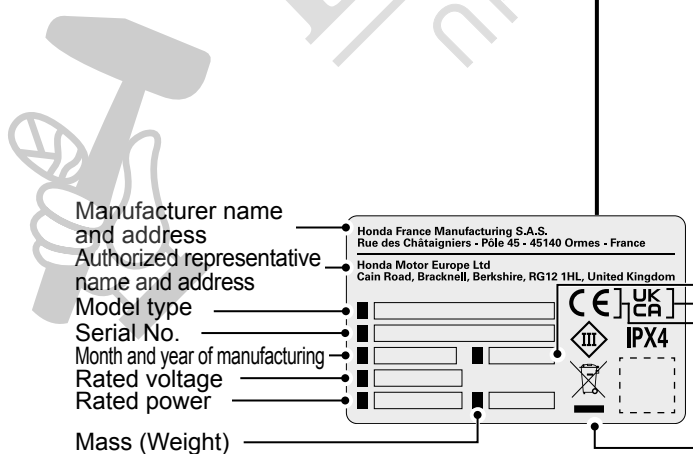
 Keep all persons and animals away from the Honda Robotic Lawnmower area.


 Do not touch the rotating blade. Beware of sharp blades : blade in movement. Operate the disabling device before working on or lifting the machine.

 Do not ride on the machine. This machine is not a toy, keep children away from the machine.

● POSITIONING OF CE MARK, UKCA MARK, SERIAL NUMBER, AND OTHER INFORMATION

The manufacturer's name and address, CE mark, UKCA mark, serial number, and other information are in the following locations indicated in the illustration.

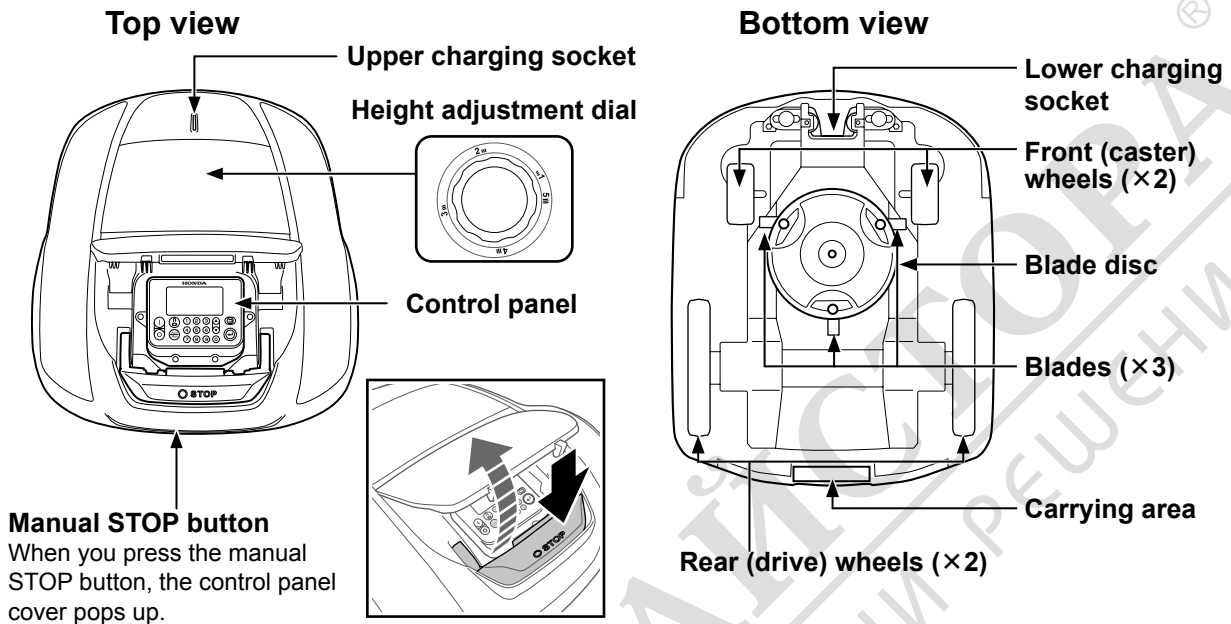


 Do not dispose of electric equipment together with household waste material. If electrical appliances are disposed of in landfills or dumps, substances can leak and react and enter into the foodchain, damaging your health and well-being. For further information on the disposal of this product, please contact your dealer or your nearest domestic waste collection service.

3 PREPARATION

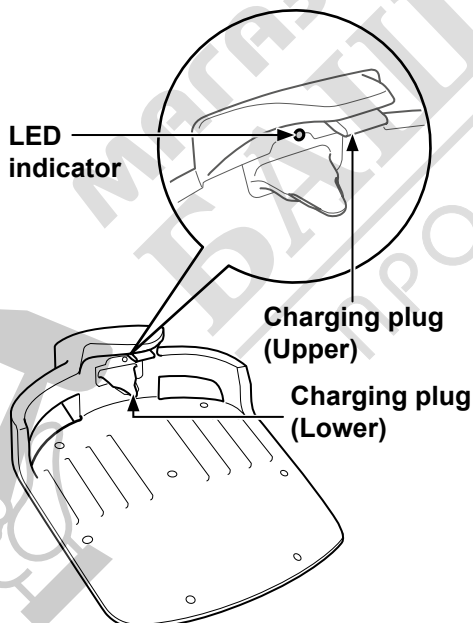
Component identification

● Body*

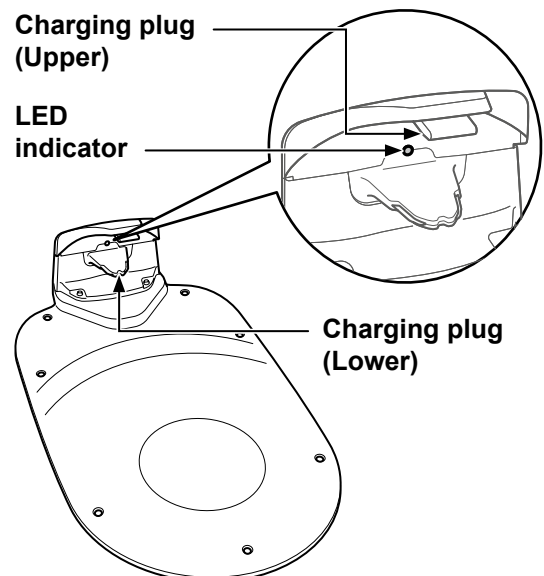


● Docking station

HRM1000, HRM1500, HRM1500 Live



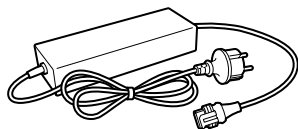
HRM2500, HRM2500 Live



The lawnmower recharges at the docking station, and returns to the docking station when mowing is finished or the battery's charge becomes low.

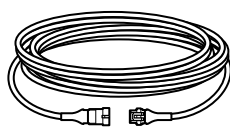
You can check the status of the boundary wire with the LED indicator (see page 86).

● Supplied items



AC adapter

Install the AC adapter off the ground. After making all other connections, connect the AC adapter to the power outlet (House).



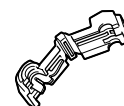
Extension cord

If the power cord of the AC adapter is not long enough, you can extend it with the extension cord. Length: 10 m (HRM1500/HRM1500 Live/HRM2500/HRM2500 Live) 3 m (HRM1000)



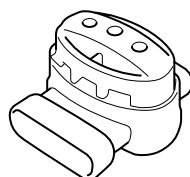
Screws

Fix with this screw on the ground when laying the docking station. Quantity: 7



Connectors for the boundary wire and the shortcut wire

Use connectors to bind the boundary wire and the shortcut wire, and connect it to the docking station. Quantity: 3 (HRM1500/HRM1500 Live/HRM2500/HRM2500 Live) 2 (HRM1000)



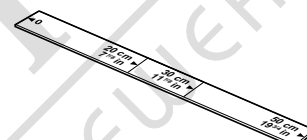
Splice connector (HRM1500/HRM1500 Live/HRM2500/HRM2500 Live)

Use the splice connectors when connecting the shortcut wire to the boundary wires. Quantity: 1



Spare blades

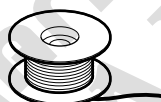
Use spare blades to replace the worn ones. Quantity: 3



Ruler

Part of the packaging of this product is a ruler. This ruler is used to check the position of the boundary wire installation.

● Accessories



Boundary wire

Lay boundary wire around the area in which you want the lawnmower to operate.

* Purchase boundary wire and wire pegs at your dealer.



Pegs

Use pegs to hold the boundary wire in place when laying it.

● Application



Mii-monitor

Download from the App Store® or Google Play™. You can remotely operate the lawnmower. (page 79)

App Store®



Google Play™



Scan the QR code to download Mii-monitor. Data charges may apply when downloading the application.

Control panel and Home screen

Control panel (HRM1500, HRM1500 Live, HRM2500, HRM2500 Live)

Display

The home screen and menus can be seen here while the lawnmower is turned on.

(On) button

Press to turn on the power.

(Off) button

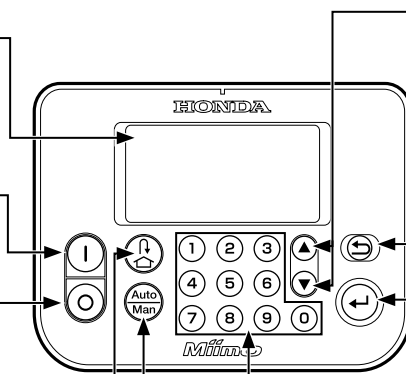
Press to turn off the power.

NOTE:

- The timer does not function if you turn off the power.

(Home) button

Press to automatically return the lawnmower to the docking station after you close the control panel cover.



▲ / ▼ (Up/down) buttons

Press to navigate to the previous/next item in the display.

⏪ (Back) button

Press to return to the previous menu in the display. (The back button cannot be used in some cases.)

⏩ (Enter) button

Press to enter your selection in the display.

Number buttons

Press to enter numbers in the display menus. When there is a number to the left of a display menu item, you can press the number button to move to the screen of the corresponding item.

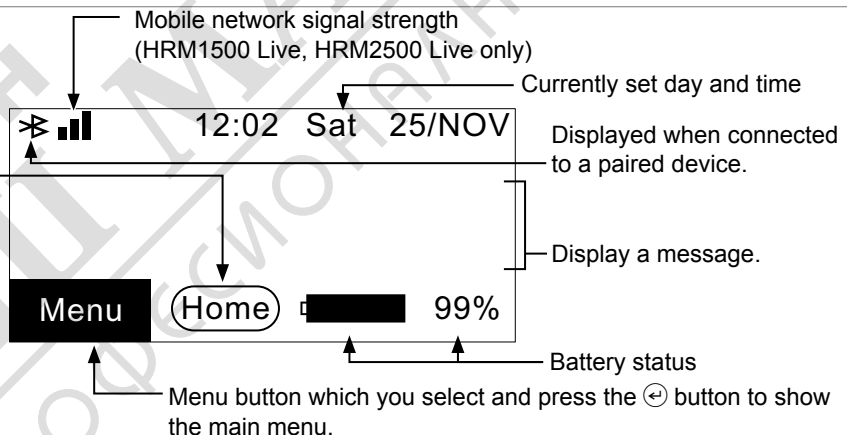
⏸ (Auto/Manual selection) button

Press from the home screen to switch between operation modes. You can choose from the Auto mode or Manual modes.

Home screen

Mode selection button on which Lawnmower setting status is displayed as below:

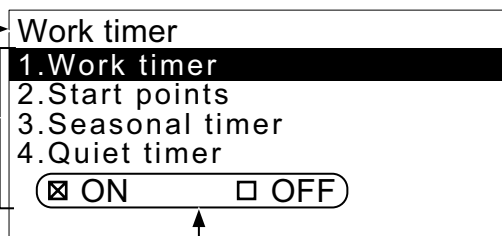
Icons	Description
	Auto mode is set.
	Manual mode is activated and the lawnmower mows without following the timer.
	The lawnmower will return to the docking station.



Item selection screen

Name of the first level menu

Selectable menu items and current setting status



You can display the previous screen by pressing the ⏪ button.

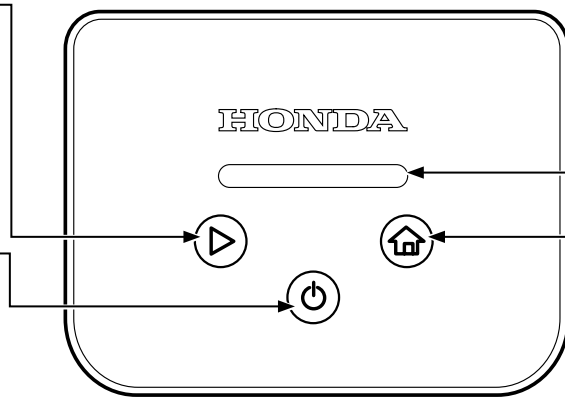
Selectable boxes to which you add a check by pressing the ⏩ button.

● Control panel (HRM1000)

Operations other than the following button operations are performed using Mii-monitor. (☞ page 79)

▶ **(Mode/Activate) button**
Press to confirm command.
Press and hold to switch between the Auto mode and Manual Mode*.

⏻ **(Power On/Off) button**
Press to turn on the power.
Press and hold for 3 seconds to turn off the power.



Indicator
The mode and error status are indicated by LED colors and blinking patterns. See the table below for details.

🏠 **(Home) button**
Press to select Home mode (last one used).
Press and hold to switch between "Home mode + restart in the Auto mode on next timer" and "Home mode + Stay at Home."

* Manual mode is "Manual then Auto" (The lawnmower work with Auto mode after working with Manual mode specified times(Fixed 10 times))

● Indicator lighting / blinking pattern and the lawnmower status

Lighting / blinking pattern	Status
Indicator turns off	Turn off the power
White blinking (at 0.5 second intervals)	Waiting PIN input
Blue lighting	Start working (Auto mode)
Blue blinking (at 0.5 second intervals)	Waiting "▶ button" pressing before work (Auto mode)
Green lighting	Start working (Manual mode)
Green blinking (at 0.5 second intervals)	Waiting "▶ button" pressing before work (Manual mode)
Yellow lighting	Start to home (Restart on next timer)
Yellow blinking (at 0.5 second intervals)	Waiting "▶ button" pressing before home (Restart on next timer)
Amber lighting	Start to home (Stay at home)
Amber blinking (at 0.5 second intervals)	Waiting "▶ button" pressing before home (Stay at home)
Red blinking (at 0.5 second intervals)	Error
White lighting	Connecting Dr-H

● The labels above the control panel

Press and hold ▶ button for 3 seconds, the LED will blink blue, and press the ▶ button, the LED will turn blue. After closing the control panel cover, the mower starts mowing in the Auto mode.

Press and hold 🏠 button for 3 seconds, the LED will blink yellow, and press the ▶ button, the LED will turn yellow. After closing the control panel cover, the lawnmower automatically returns to the docking station and wait for the next auto mode timer.



Press and hold for 3 seconds to switch.






Press and hold for 3 seconds to switch.

Press and hold ▶ button for 3 seconds, the LED will blink green, and press the ▶ button, the LED will turn green. After closing the control panel cover, the mower starts mowing in the Manual mode.

Press and hold 🏠 button for 3 seconds, the LED will blink amber, and press the ▶ button, the LED will turn amber. After closing the control panel cover, the lawnmower automatically returns to the docking station.

● Home screen operation

• Displaying the menu screen




Select [Menu] on the home screen with the   button on the control panel and press the  button.

Menu	12:02 Sat 25/NOV
1. Work timer	
2. Garden setup	
3. Diagnostics	
4. History	
5. System settings	
6. Setup wizard	

Menu top screen is displayed.

For details on the menu screen, see “4 MENU SETTINGS” (▣ page 44).

• Mowing setup

Select [Auto] and [Man] on the home screen with the   button on the control panel and press the  button.

Mowing setup	12:02 Sat 25/NOV
1. Start points	
2. Mowing pattern	
3. Advanced setting	
4. GNSS	


The mowing setup screen is displayed.

For details on how to change the settings, refer to “Setting the lawnmower operation” (▣ page 52).

• Manual mode settings





Select Manual mode with the  button on the control panel.

Manual mode	12:02 Sat 25/NOV
<input checked="" type="checkbox"/> Mow until empty	
<input type="checkbox"/> Mow then recharge continuously	
<input type="checkbox"/> Mow then resume auto timer	

Switch to Manual mode. Select one of the three work patterns and press the  button.

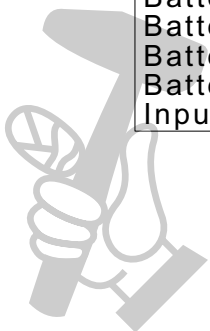
For more information about Manual mode, refer to “Operating the lawnmower in the Manual mode” (▣ page 90).

• Battery status

Select  on the home screen with the   button on the control panel and press the  button.

Live data	12:02 Sat 25/NOV
Battery voltage	22.4[V]
Battery current	4.0[A]
Battery level	45[%]
Battery temp	24[°C]
Input voltage	37.4[V]

Information about the battery is displayed.



Installation

We recommend that an authorised Honda dealer performs the installation of your Robotic Lawnmower.

Checking conditions for installation

Check with the dealer that performed the installation if the docking station and boundary wire are installed according to the conditions below. Also periodically confirm that these conditions are still met.



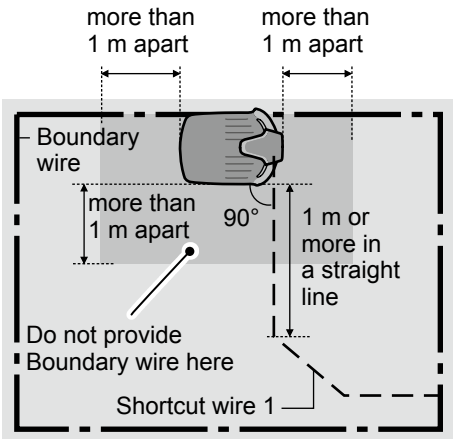
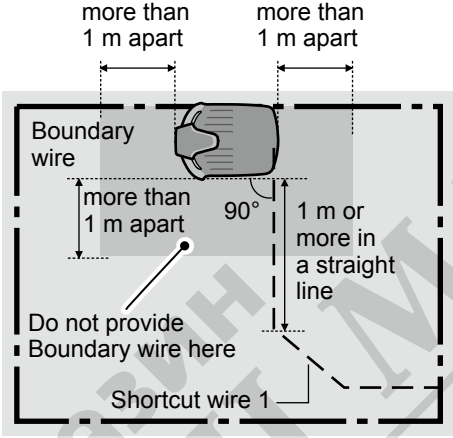
If any of these conditions are not met, consult your dealer.

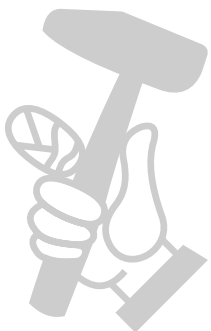
It is recommended that the mains power supply is professionally installed in line with local laws and regulations.

Conditions for installing the docking station (HRM1000, HRM1500, HRM1500 Live)

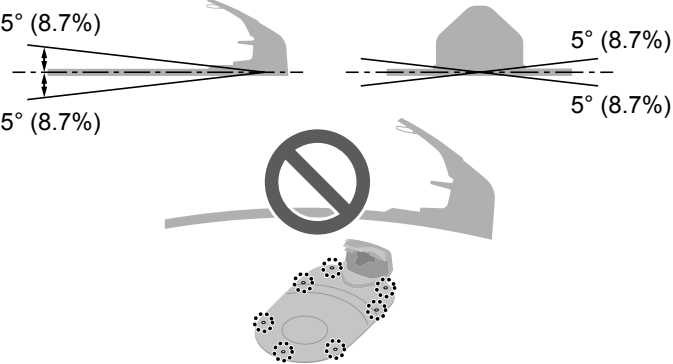
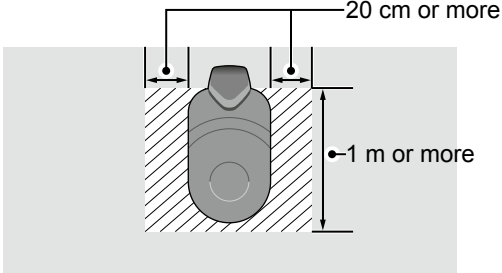
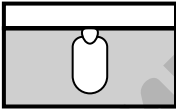
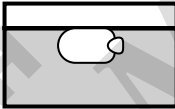

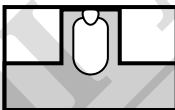
Image	Condition																						
<p>5° (8.7%) 5° (8.7%) 5° (8.7%) 5° (8.7%)</p>	<ul style="list-style-type: none"> The docking station must be installed on a flat surface with an inclination of no more than 5° (8.7%). The docking station must not be curved. The screws must be firmly tightened. Before installing the docking station, check the ground condition which may vary seasonally. It may be necessary to maintain the ground with the season. If installing the docking station directly on the lawn, cut the grass on which the docking station will be located as short as possible. Because of a wrong installation of the docking station, the lawnmower may not be charged. 																						
<p>Shortcut wire (Only HRM1500, 1500 Live)</p> <p>Right side wire Type 1</p> <p>Left side wire Type 2</p> <table border="1" data-bbox="236 1476 911 1771"> <thead> <tr> <th colspan="2"></th> <th colspan="2">Docking direction</th> </tr> <tr> <th colspan="2"></th> <th>CW (Clockwise)</th> <th>ACW (Anti-clockwise)</th> </tr> </thead> <tbody> <tr> <td rowspan="2">Boundary wire length</td> <td colspan="2"> </td> <td colspan="2"> </td> </tr> <tr> <td>Left side wire connector</td> <td>Right side wire connector</td> <td>Left side wire connector</td> <td>Right side wire connector</td> </tr> <tr> <td>0-400 m</td> <td>Type 2</td> <td>Type 1</td> <td>Type 2</td> <td>Type 1</td> </tr> </tbody> </table>			Docking direction				CW (Clockwise)	ACW (Anti-clockwise)	Boundary wire length					Left side wire connector	Right side wire connector	Left side wire connector	Right side wire connector	0-400 m	Type 2	Type 1	Type 2	Type 1	<p>You need to set the loop direction CW (Clockwise) or ACW (Anti-clockwise) when the lawnmower returns to the docking station. You also need to connect the connectors of the boundary wire with the terminals of the docking station with reference to the left table.</p>
		Docking direction																					
		CW (Clockwise)	ACW (Anti-clockwise)																				
Boundary wire length																							
	Left side wire connector	Right side wire connector	Left side wire connector	Right side wire connector																			
0-400 m	Type 2	Type 1	Type 2	Type 1																			

Image	Condition
	<ul style="list-style-type: none"> • The boundary wire must be laid according to the figure on the left. • There must be no obstacles within 1m of the docking station. • There must not be foreign objects within the work area near the docking station (in the shaded area indicated in the image). • The boundary wire under the docking station must be laid toward the outside of the work area.
<p>Docking direction</p> <p>Pattern 1* Pattern 2 </p> <p>Pattern 3 </p> <p>*Except HRM1000</p>	<p>Docking direction</p> <p>There are three patterns* for installing the docking station displayed on the setting screen (☞ page 32).</p> <p>*If you are using HRM1000, you can select pattern 2 or pattern 3.</p>
<p>Example of correct installation</p> <div style="border: 1px solid black; padding: 5px; margin-bottom: 10px;"> <p>The lines in the illustration are distinguished as follows.</p> <p>- - - - - Boundary wire</p> <p>- - - - - Shortcut wire</p> </div> <p>Pattern 1 </p> <p>With shortcut wire (HRM1500, HRM1500 Live)</p>	<p>NOTE:</p> <ul style="list-style-type: none"> - Up to one shortcut wire can be installed. - There must be no obstacles within 1m of the docking station. <p>Pattern 1 : Perpendicular installation</p> <p>Keep the boundary wire at least 1 m away from the right side face, left side face, and back face of the station.</p> <p>Keep the shortcut wire straight at least 1 m from the station.</p> <p>NOTE:</p> <p>Attach the shortcut wire to the right side from the front view.</p>

Image	Condition
<p>Pattern 2  / Pattern 3 </p> <p>With shortcut wire (HRM1500, HRM1500 Live)</p>  	<p>Pattern 2: Clockwise installation Keep the boundary wire at least 1 m away from the right side face, left side face, and back face of the docking station. *When installing it at a corner, keep the station within 20 cm to the corner. Keep the shortcut wire straight at least 1 m from the docking station. Attach the boundary wire (AL side) to the back of the left side of the docking station.</p> <p>NOTE: Attach the shortcut wire to the left side from the front view.</p> <p>Pattern 3: Anti-clockwise installation Keep the boundary wire at least 1 m away from the right side face, left side face, and back face of the docking station. *When installing it at a corner, keep the station within 20 cm to the corner. Keep the shortcut wire straight at least 1 m from the docking station. Attach the boundary wire (AR side) to the back of the left side of the docking station.</p> <p>NOTE: Attach the shortcut wire to the right side from the front view.</p> <p>Lay the shortcut wire along the side of the station. Lay the shortcut wire at least 1m straight away from the docking station's back.</p>



● Conditions for installing the docking station (HRM2500, HRM2500 Live)

Image	Condition
	<ul style="list-style-type: none"> • The docking station must be installed on a flat surface with an inclination of no more than 5° (8.7%). • The docking station must not be curved. • The screws must be firmly tightened. • Before installing the docking station, check the ground condition which may vary seasonally. It may be necessary to maintain the ground with the season. • If installing the docking station directly on the lawn, cut the grass on which the docking station will be located as short as possible. • Because of a wrong installation of the docking station, the lawnmower may not be charged.
	<p>Install the docking station in a place where there are no obstacles in the area indicated with the slanted line.</p> <p>Place the docking station away from obstructions such as buildings, trees, etc.</p> <p>The lawnmower uses GNSS location information to store the location of the docking station and return to the docking station. If the docking station is installed behind obstructions, GNSS location information may not be obtained and the function may not work.</p>
<p>Docking direction</p> <div style="display: flex; justify-content: space-around;"> <div style="text-align: center;"> <p>Pattern 1</p>  </div> <div style="text-align: center;"> <p>Pattern 2</p>  </div> </div> <div style="display: flex; justify-content: space-around; margin-top: 10px;"> <div style="text-align: center;"> <p>Pattern 3</p>  </div> <div style="text-align: center;"> <p>Pattern 4</p>  </div> </div>	<p>Docking direction</p> <p>There are four patterns for installing the docking station displayed on the setting screen (☰ page 32).</p>

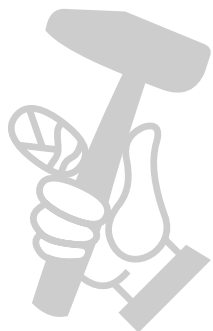

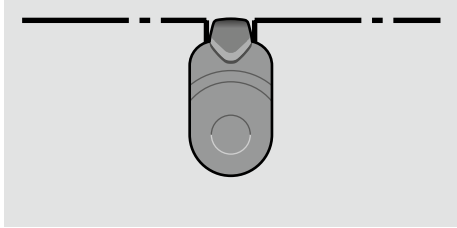
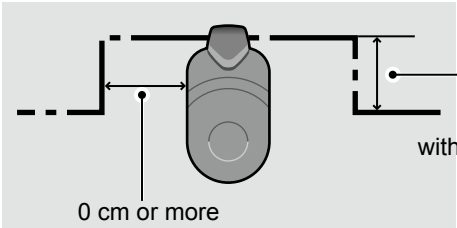
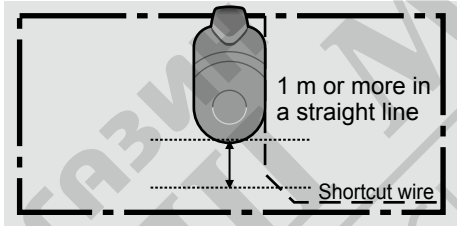


Image	Condition
<p>Example of correct installation</p> <p>The lines in the illustration are distinguished as follows.</p> <ul style="list-style-type: none"> - - - - - Boundary wire - - - - - Shortcut wire <p>Pattern 1 </p> <p>Without shortcut wire</p>   <p>With shortcut wire</p>  <p>*: more than 30 cm apart</p>	<p>NOTE: Up to one shortcut wire can be installed.</p> <p>Pattern 1: Perpendicular installation Connect the docking station perpendicular to the wire.</p> <p>Lay the shortcut wire along the side of the station. Lay the boundary wire and the shortcut wire with an interval of 30 cm or more. Lay the shortcut wire at least 1m straight away from the docking station's back.</p>

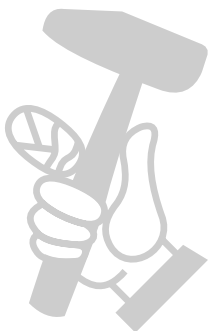


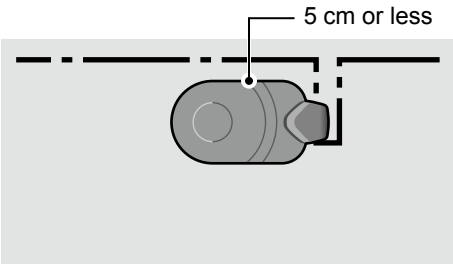
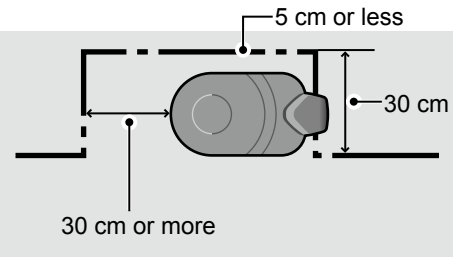
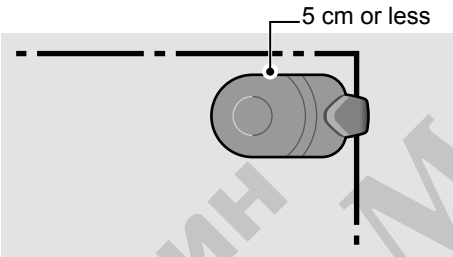
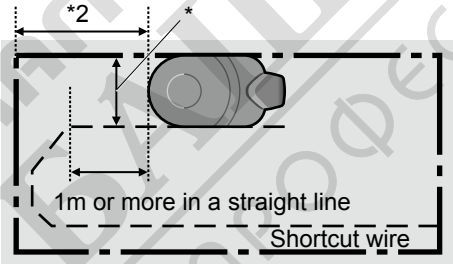
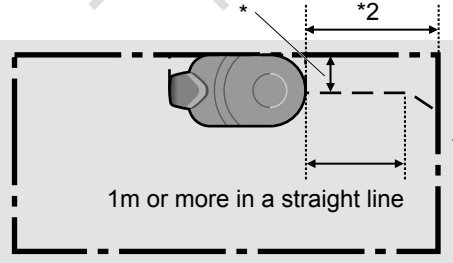


Image	Condition
<p>Pattern 2  / Pattern 3 </p> <p>Without shortcut wire</p>   	<p>Pattern 2: Clockwise installation Connect the docking station parallel to the boundary wire (in the clockwise direction).</p> <p>Pattern 3: Anti-clockwise installation Connect the docking station parallel to the boundary wire (in the Anti-clockwise direction).</p>
<p>With shortcut wire</p>   <p>*: more than 30 cm apart *2: more than 2 m apart</p>	<p>Lay the shortcut wire along the left and right sides of the docking station. Lay the boundary wire and the shortcut wire with an interval of 30 cm or more. Lay the shortcut wire at least 1m straight away from the docking station's back.</p>

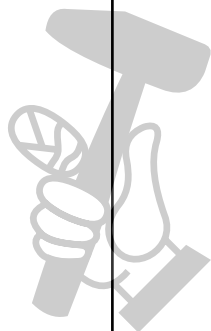



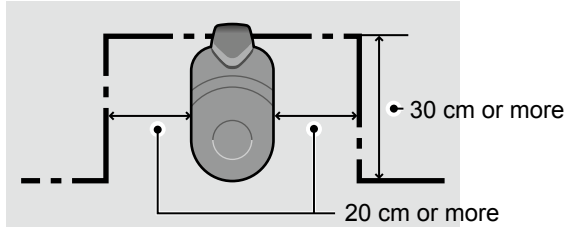
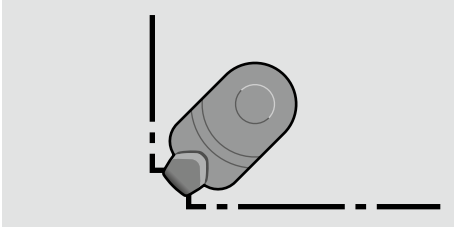
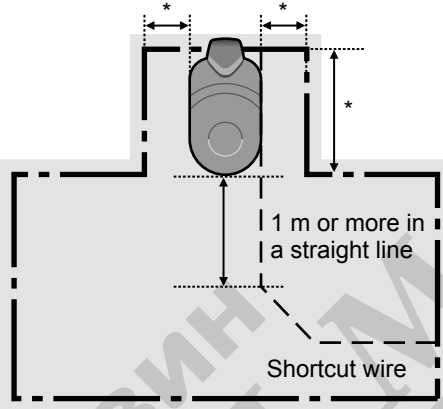
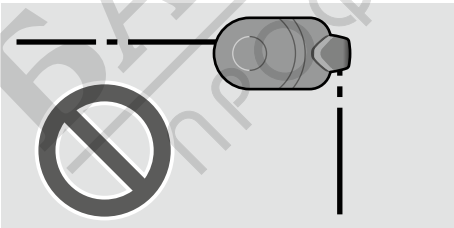
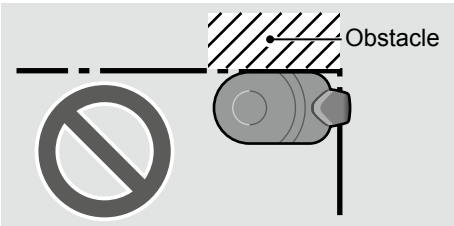
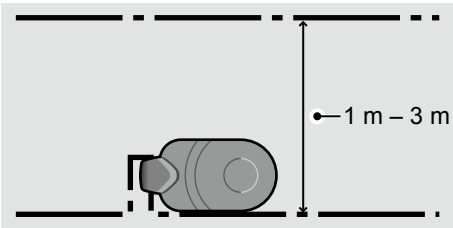
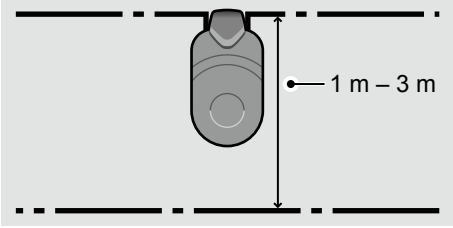
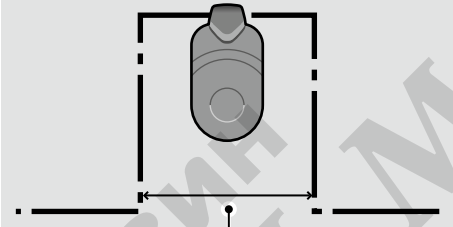
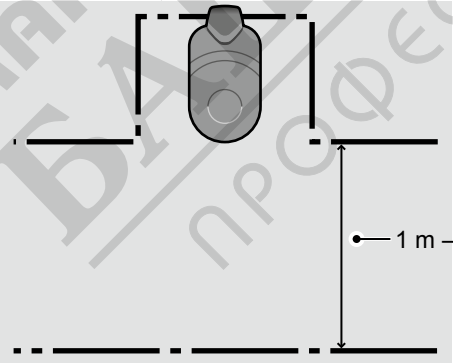
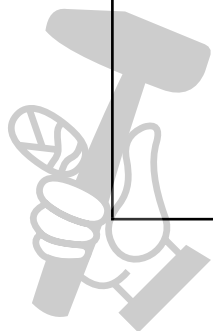
Image	Condition
<p>Pattern 4 </p> <p>Without shortcut wire</p>   <p>With shortcut wire</p>  <p>*: more than 30 cm apart</p>	<p>Pattern 4: Alcove installation Connect the docking station in an alcove.</p> <p>Lay the boundary wire around 30 cm or more apart from the docking station sides. Lay the boundary wire and the shortcut wire with an interval of 30 cm or more. Lay the shortcut wire at least 1m straight away from the docking station's back.</p>
<p>Example of incorrect installation</p> <p>Example 1</p>  <p>Example 2</p> 	<p>Example 1 Do not run the boundary wire underneath the docking station.</p> <p>Example 2 Do not place obstacles beside the docking station. Obstacles must be separated from the wire by a distance of 30 cm or more.</p>

Image	Condition
<p data-bbox="204 206 903 244">Example of narrow passage installation</p> <p data-bbox="220 267 847 297">Select Pattern 2 or Pattern 3 for the following example.</p>  <p data-bbox="220 637 703 666">Select Pattern 4 for the following example.</p>   	<p data-bbox="927 263 1246 292">Narrow passage installation</p> <ul data-bbox="927 292 1445 399" style="list-style-type: none"> • A narrow passage is one in which the distance between wires is 3 m or less. • Do not make the distance between wires 1 m or less. <p data-bbox="927 433 1002 462">NOTE:</p> <ul data-bbox="927 462 1445 512" style="list-style-type: none"> - For narrow passage installations, do not select docking direction Pattern 1.



● **Conditions for laying the boundary wire**

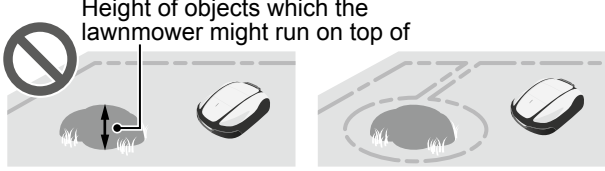
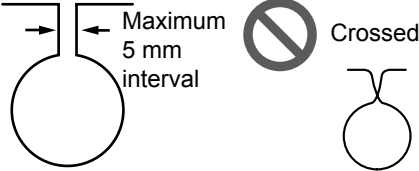
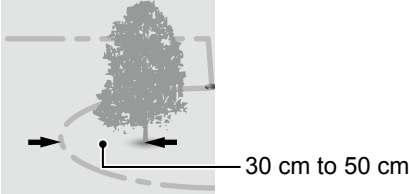
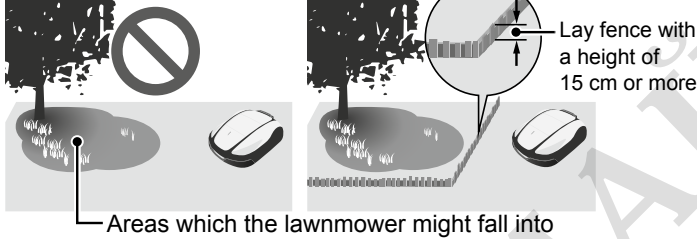
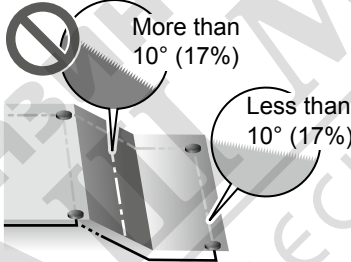
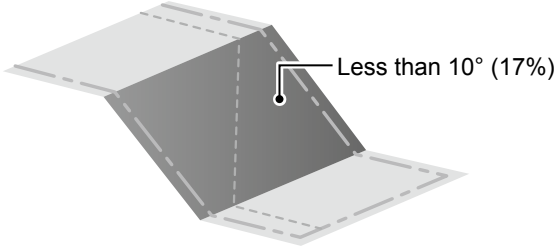

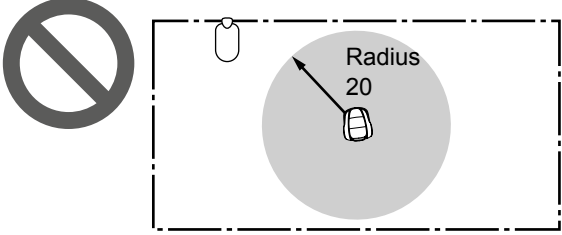
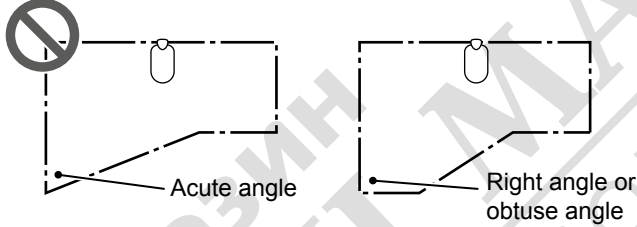
Image	Condition
	<p>Lay boundary wire around objects which the lawnmower might run on top of (e.g. rocks, tree roots, etc.); these objects must be removed from the work area.</p>
	<p>The boundary wire entry and exit points for a round area should be separated by less than 5 mm. (However, the boundary wire should not cross itself.)</p>
	<p>There must be 30 cm to 50 cm of space between the boundary wire and large objects. (This space can be reduced to as low as 30 cm if you set [Wire Overlap] to a low value. For details, consult your dealer.)</p>
	<p>Lay fence around areas which the lawnmower might fall into, such as uneven ground, ponds, pools, driveways, or other areas with differences in height.</p>
	<p>The work area must conform to the following conditions if it includes sloping areas. Laying the boundary wire where the slope is too steep has a bad effect on the lawnmower. This is because the lawnmower follows along where the boundary wire has been laid.</p> <ul style="list-style-type: none"> • The lawnmower can operate on slopes of 24° (45%). Do not include slopes in the work area that are more than 24° (45%). • Lay the boundary wire in locations that have a slope of less than 10° (17%). • If the location in which you are laying the boundary wire has a slope that is steeper than 10° (17%), do the following. <ul style="list-style-type: none"> - Do not lay the boundary wire laterally across a slope that is steeper than 10° (17%). - Lay the boundary wire laterally across a relatively flat space, with a slope of less than 10° (17%), that comes after the location where the slope is more than 10° (17%). (Refer to the left diagram.)

Image	Condition
<p>With shortcut wire (HRM1500/HRM1500 Live/HRM2500/HRM2500 Live)</p> 	<p>The shortcut wire can be laid on slopes of less than 10°(17%). If the shortcut wire is laid on a slope of less than 10°(17%), lay it obliquely to the slope.</p>
	<p>Boundary wire should be laid so that there is no excess wire.</p>
	<p>The lawnmower can detect the signal from the boundary wire within a 20 m radius. If the lawnmower enters a space inside the work area with no boundary wire within a 20 m radius, the signal will not be detected and the lawnmower will stop. Maximum area: 1000 m² (HRM1000), 1500 m² (HRM1500, HRM1500 Live), 3000 m² (HRM2500, HRM2500 Live)</p>
	<p>The boundary wire must not be laid with any acute angles. (Angles should be more than 90°.)</p>

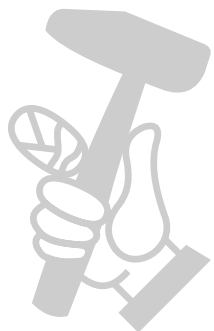
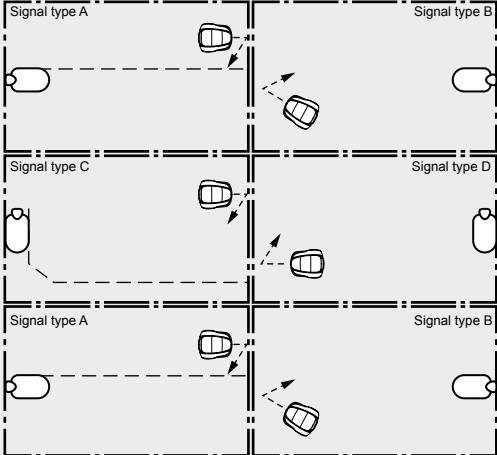
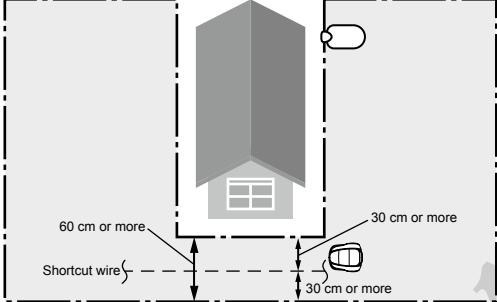
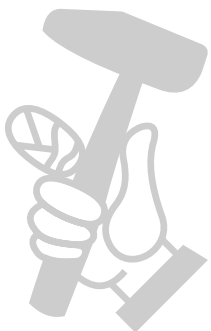
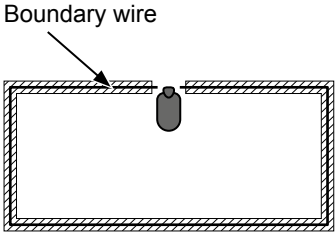
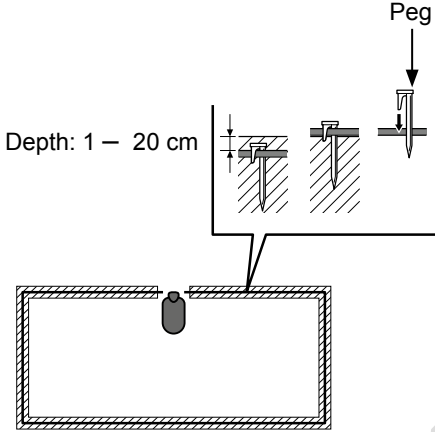
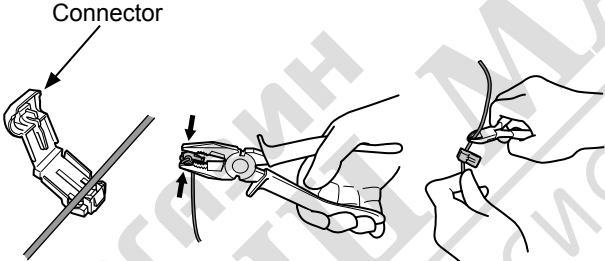


Image	Condition
<p data-bbox="236 206 868 235">How to install multiple lawnmowers in adjacent zones</p> 	<p data-bbox="948 199 1453 403">You can install multiple adjacent work areas if you want to use multiple lawnmowers by changing the type of signal that travels through each wire. Set the adjacent areas' signal types to be different in that case. In the menu screen [2. Garden setup] (☰ page 64), select the 4 signals types (A, B, C, D).</p> <p data-bbox="948 405 1453 489">*The signal types are the same for all models. Change the signal type even if different models are adjacent to each other.</p> <p data-bbox="948 492 1453 576">Additionally, each boundary wire needs to be laid apart to prevent work areas from overlapping.</p> <p data-bbox="948 610 1023 637">NOTE:</p> <ul data-bbox="948 639 1453 728" style="list-style-type: none"> - Set "Passage width" (☰ page 53) and "Wire overlap" (☰ page 57) appropriately to keep the mowers from colliding with each other.
	<p data-bbox="948 773 1453 857">Narrow passage (distance between wires) should be more than 1 m, if no shortcut wire is used.</p> <p data-bbox="948 891 1453 1034">When laying the boundary wire and shortcut wires together, make sure there is a space of at least 60 cm between each boundary wire and at least 30 cm between the boundary wires and the shortcut wires.</p>



● Installing boundary wire and connecting to the docking station

Image	Operation
	<p>Set the boundary wire by using the "LAWN DIAGRAM" (see page 124).</p> <ul style="list-style-type: none"> • Leave enough wire to ensure that small adjustments can be made, double backing outside of the loop is acceptable. • Do not fix the wire until finish the layout. • The boundary wire should be laid so that there is no excess wire.
	<p>Fix the boundary wire with pegs to the specified depth as shown.</p>
	<p>Attach a connector to both ends of the boundary wire.</p> <ol style="list-style-type: none"> 1. Put the boundary wire in the grip area of the connector. 2. Press the connector click with a plier. 3. Cut the position of 1-2 cm from the each connector.

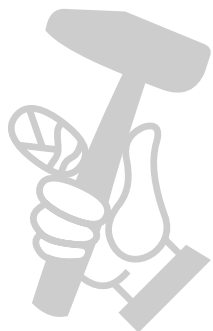
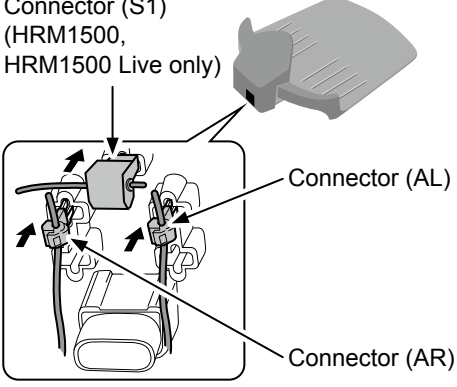
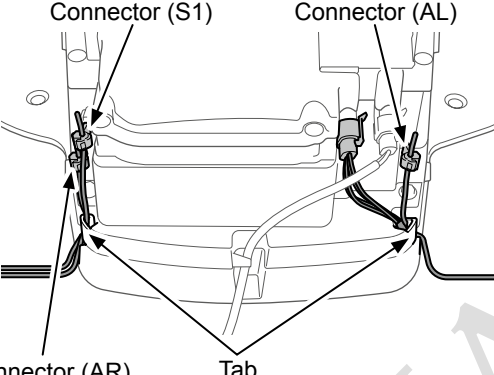
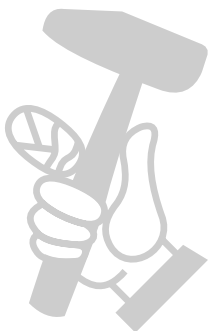


Image	Operation
<p>HRM1000, HRM1500, HRM1500 Live</p> <p>Connector (S1) (HRM1500, HRM1500 Live only)</p> 	<p>The boundary wire must not be crossed when connecting to the docking station. Attach each wire to the station's connector according to the instructions on the label attached to the station.</p> <p>Boundary wire left side: AL Boundary wire right side: AR Shortcut wire 1: S1 * (*HRM1500, HRM1500 Live, HRM2500, HRM2500 Live only)</p>
<p>HRM2500, HRM2500 Live</p> 	<ol style="list-style-type: none"> 1. Remove the connector cover/station cover (☞ page 84). 2. Pass the boundary wire and the shortcut wire through the tabs as shown (HRM2500, HRM2500 Live only). 3. Insert the connectors into the pins. 4. Install the station cover. <p>NOTE: - To connect the AC adapter to the docking station (☞ page 84).</p>



Setting up the lawnmower

*If your lawnmower model type is HRM1000, use Mii-monitor on smartphone/tablet. Refer to “5 Mii-monitor Preparation” (page 79).

When turning the lawnmower on initially, the initial settings will appear.

Through the initial settings, you can configure the display language, internal date and time, and create your PIN (Personal Identification Number).



Once initial settings are done, you can configure the settings for the mowing operation of your lawnmower using the setup wizard.



Setup wizard can be done on the display or using Mii-monitor smartphone/tablet application.

NOTE:

- If your dealer already configured the setup wizard, the setup wizard screen is not displayed.

Turning on the power

After the battery is charged, press the  (On) button (HRM1500, HRM1500 Live, HRM2500, HRM2500 Live) /  (Power On/Off) button (HRM1000) to turn on the lawnmower.

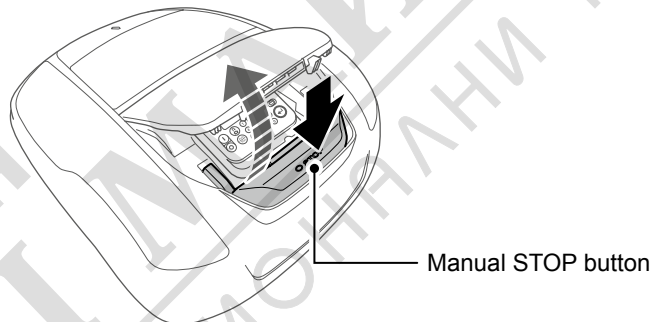
The  /  button is located on the control panel towards the rear side of the lawnmower.

⚠ WARNING

- Do not insert your finger beneath the closed control panel cover.

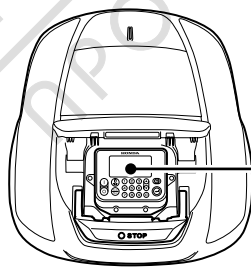
1

Press the manual STOP button.
The control panel cover pops up.

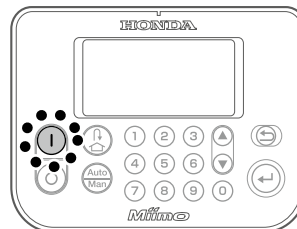


2

Press the  /  button on the control panel.



HRM1500, HRM1500 Live,
HRM2500, HRM2500 Live



HRM1000



HRM1500, HRM1500 Live, HRM2500, HRM2500 Live

The power turns on, and the initial setup screen on the control panel is displayed.

HRM1000

The power turns on, and the indicator blinks white.

Initial settings

You can execute the setup wizard not only on the control panel of the lawnmower, but also in Mii-monitor. If you have not yet installed Mii-monitor, refer to “5 Mii-monitor Preparation” (page 79).


When turning the lawnmower on initially, the initial settings will appear to set the display language, internal date and time, and create your PIN (Personal Identification Number).

Initial settings are performed on the control panel. After initial settings, you can use Mii-monitor to change the settings.

⚠ WARNING


- Make sure to press the manual STOP button before performing the following procedure.

1

Select your preferred language and press the  button.

Initial setup Select language
1. English
2. Deutsch
3. Français
4. Italiano
5. Nederlands
6. Svenska

2

Enter the date with the format {Day}/{Month}/{Year} and the time in 24-hour format, and select [OK] and press the  button.

Initial setup Set date and time	
DD/MM/20YY	: (24h)
OK	

3

Input a PIN using the number buttons, and select [OK] and press the  button.

The message “Select install menu” is displayed. You can select the setup method.

- [1.Setup wizard] ... Step-by-step setup (page 31)
- [2.Advanced setup] ... Set up the Mowing setting/Quiet timer only (page 41)
- [3.Restart initial setup] ... Redo initial setup

Initial setup Create a PIN code
■ _ _ _
OK

NOTE:

- Write down your PIN in the space provided. See “DEALER CHECKSHEET” (page 128).

Select install menu
1. Setup wizard
2. Advanced setup
3. Restart initial setup
Finish



Initial setup is completed. Go to the setup wizard to configure the settings for the mowing operation of your lawnmower.

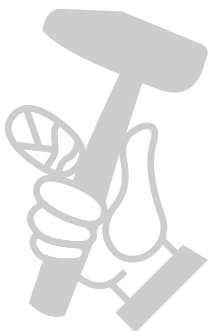
■ Configuring the settings through the setup wizard

This section explains the setup wizard procedure using the control panel on the lawnmower. The setup wizard will guide you to configure the settings for your mowing operation as follows:

Menu name	Usage	Configuring and testing the settings
[1.Garden layout]	For configuring the settings related to the layout of the boundary wire. These setting values are referred from the other settings.	<ul style="list-style-type: none"> - Signal type - Quantity of the shortcut wire - Direction for the lawnmower to dock to the docking station - Length of the boundary wire - Garden size
[2.Start points]	For configuring the mowing start point settings to enable the lawnmower to start mowing from other areas than from docking station.	<ul style="list-style-type: none"> - Direction of the mowing start points - Distance of the start points from the docking station - Ratio with which the lawnmower operates in each area
[3.Test start points]	For testing the start points configured in [2.Start points] menu.	<ul style="list-style-type: none"> - Testing the setting of each start point
[4.Work timer]	For setting the work timer to operate the lawnmower according to the schedule.	<ul style="list-style-type: none"> - Work day and work time - Seasonal work time

NOTE:

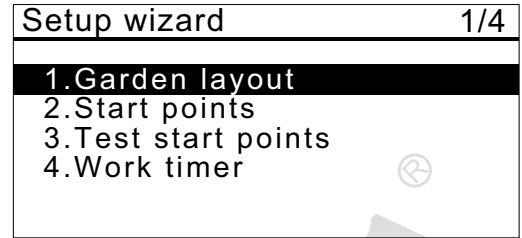
- Before starting the setup wizard, confirm the completion of installing the docking station and laying boundary wire with your dealer.
- Before starting the setup wizard, fill out the DEALER CHECKSHEET at the end of the Owner's Manual.
- If the DEALER CHECKSHEET at the end of Owner's Manual was already filled out by your dealer, refer to it when configuring the settings through the setup wizard.
- After the settings are finished through the setup wizard, you can modify the setting values in the menu settings. For details, see "4. MENU SETTINGS" (▣ page 44).
- You can also modify the setting values in Mii-monitor.



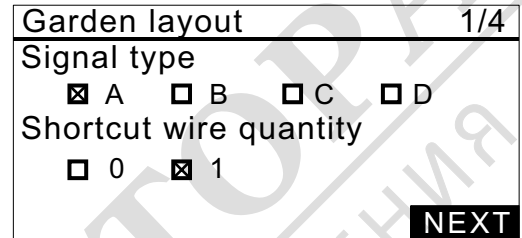
1. Setting the garden layout

Through this setting, you can configure the information of your garden layout for operating the lawnmower.

1-1 [1.Garden layout] is selected. Press the button to configure the garden layout. Garden layout screen is displayed.



1-2 Select the signal type and number of the shortcut wire (excepted for HRM1000), and press the button. Then select [NEXT] and press the button. [Dock the mower in the station] is displayed.

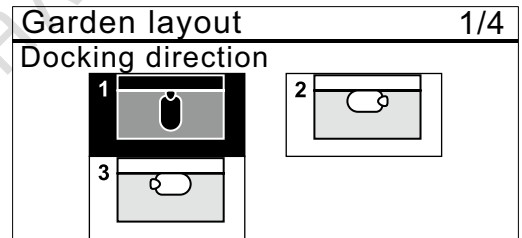


1-3 Place the lawnmower in the docking station. [Please wait...] is displayed and then [Finish] is displayed. If the mower is set in the docking station, part it from the station and set it in the station again.

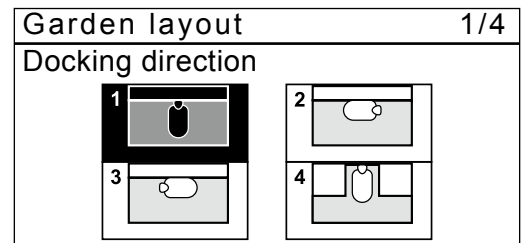
1-4 [NEXT] is selected, press the button. The [Docking direction] select screen is displayed.

1-5 Select an installation pattern for the docking station, and press the button. Refer to page 16, to confirm which pattern matches your actual installation.

HRM1500, HRM1500 Live



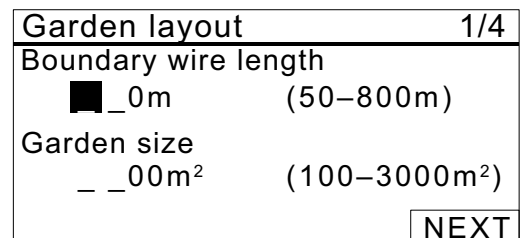
HRM2500, HRM2500 Live





1-6 Enter the values of the boundary wire length and garden size, [NEXT] is selected, press the button.

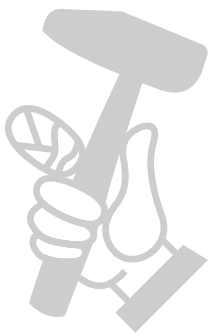
NOTE:

- For details on the boundary wire length or garden size, contact your dealer.
- Input the boundary wire length exactly because the values which are automatically configured are associated with the boundary wire length.



1-7 **When you are finished inputting a value, press the  button. [NEXT] will be selected. Press the  button again.**

The configuration of garden layout is completed.
The setup wizard top screen is displayed and [2.Garden layout] is checked.

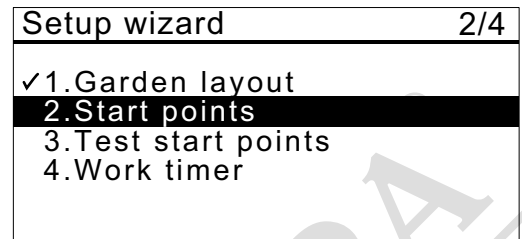


МАГАЗИН
БАШ МАЙСТОРА®
ПРОФЕСИОНАЛНИ РЕШЕНИЯ

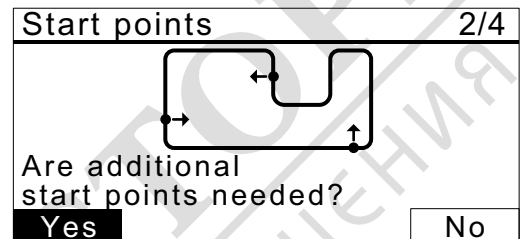
2. Setting the start points

Through this setting, you can set the starting point to operate the lawnmower. If you set the start points and combine them with the settings of work timer, you can effectively mow your garden.

2-1 Select [2.Start points] and press the button to configure the start points. Start points screen is displayed.



2-2 Select [Yes] or [No] to the question on the addition of the start points and press the button. If you select [Yes], go to step 2-3. If you select [No], no start point is added and the setup wizard top screen is displayed.

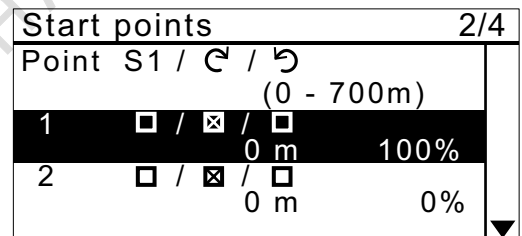


NOTE:

- When selecting [No], [2.Start points] and [3.Test start points] are checked on the setup wizard top screen.
- When selecting [No], the lawnmower will always start mowing from the docking station.

2-3 Select any point and press the button. The setting screen for the point to be set is displayed.

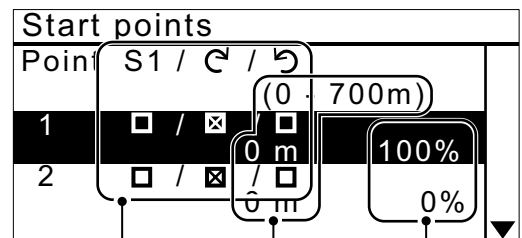
2-4 Select S1(Shortcut wire 1), (Clockwise), or (Anti-clockwise), enter the values of the distance from the docking station to start cutting, and enter a percentage of the ratio which the lawnmower operates. Repeat the above operation for the starting points which you want to configure. Allocate to each start point so that the total utilization rate is 100%.



TIPS How to read the above screen
For details, refer to "Start points" (page 55).

NOTE:

- You can configure the following start points for each model:
HRM1000, HRM1500, HRM1500 Live: 3 start points
HRM2500, HRM2500 Live: 5 start points
- Input the usage percentage for each start point based on how often the lawnmower should start from this point once charged.
- Start point does not define a specific area of mowing. It ensures the lawnmower can reach areas difficult to access in your garden.



Shortcut wire 1/
Clockwise/
Anti-clockwise

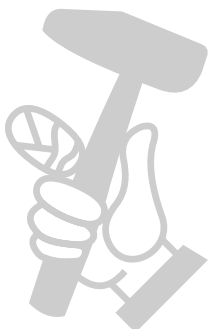
Distance to start point

Percentage to select each start point

2-5 Select [NEXT] and press the button. The configuration of mowing start points is completed. The setup wizard top screen is displayed and [2.Start points] is checked.

NOTE:

- You can modify again the settings through the setup wizard.




3. Testing the start points



Through this testing, you can check the start points which you added in [2.Start points].



NOTE:

- Perform each test when the lawnmower is connected to the docking station.

3-1 Select [3.Test start points] and press the  button to check the start points.

Setup wizard	3/4
✓1.Garden layout	
✓2.Start points	
3.Test start points	
4.Work timer	

3-2 Select a start point number and press the  button.
The information of the selected start point is displayed.
If you do not test, select [OK] and press the  button.
Go to step 4-1.

Test start points	3/4
Point S1 /  / 	
1 <input checked="" type="checkbox"/> / <input type="checkbox"/> / <input type="checkbox"/> 50m	
2 <input type="checkbox"/> / <input checked="" type="checkbox"/> / <input type="checkbox"/> 50m	
3 <input type="checkbox"/> / <input type="checkbox"/> / <input type="checkbox"/> m	
4 <input type="checkbox"/> / <input type="checkbox"/> / <input type="checkbox"/> m	
5 <input type="checkbox"/> / <input type="checkbox"/> / <input type="checkbox"/> m	
0Home	NEXT

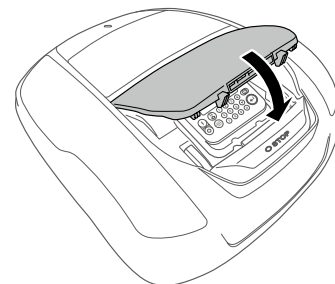
3-3 Confirm the setting information of the selected start points.

NOTE:

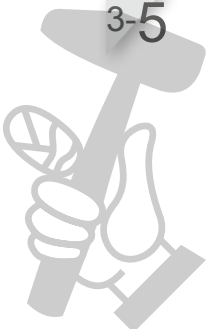
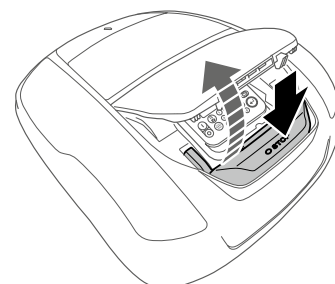
- Passage width is the distance between the lawnmower and the boundary wire or shortcut wire when following it. For example, running line 0 is 10 cm, 5 is 50 cm. For details, see "Boundary wire passage width sample table" (page 53).

Test start points	3/4
Point 1	
Location CW 0m	
Passage width 10	
Close cover to start	

3-4 Close the control panel cover.
The lawnmower starts towards the selected start point.
When the test is correctly finished, the lawnmower rolls slowly and a beep sound is emitted from the lawnmower.



3-5 Press the manual STOP button.
The control panel cover pops up.



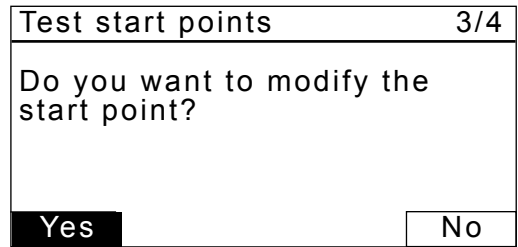
3-6

Select [Yes] or [No] to the question of the test result and press **⏪** button.

If you select [Yes], the Mowing start points screen is displayed to configure the start point settings.
If you select [No], go to step 3-7.

NOTE:

- For details on the start point settings, see step 2-3 of "2. Setting the start points" (page 34).

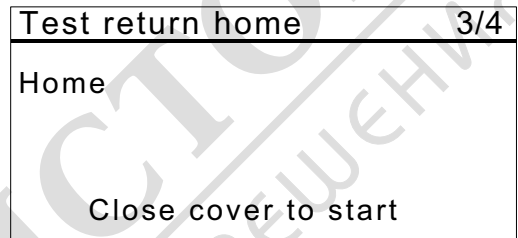
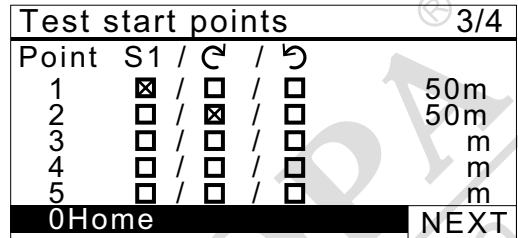


3-7

Test the return home of the lawnmower to the docking station.

Select [0 Home].

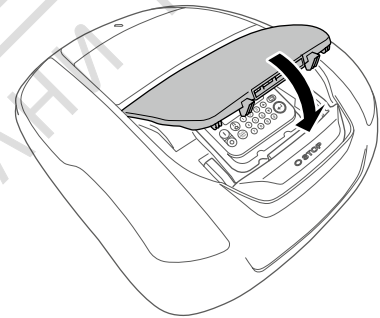
The screen of [Test return home] is displayed.



3-8

Close the control panel cover.

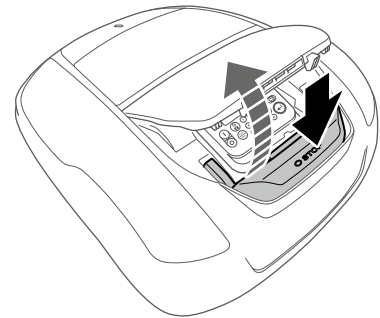
The lawnmower starts towards the the docking station.



3-9

Press the manual STOP button.

The control panel cover pops up.
The message "Test finished" appears on the display.



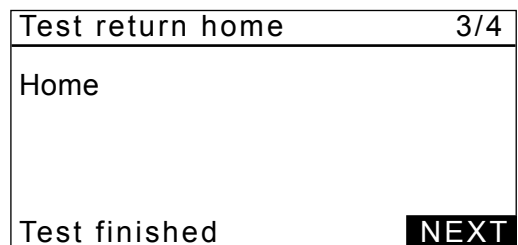
3-10

Select [NEXT] and press the **⏪** button.

The configuration of testing start points is completed.
The setup wizard top screen is displayed and [3. Test start points] is checked.

3-11


Select [NEXT] and press the **⏪** button.



4. Setting the work timer


With this setting, you can configure the work day and work time at which the lawnmower operates in the Auto mode.

4-1

Select [4.Work timer] and press the  button to configure the work day and work time.

Setup wizard	4/4
✓1.Garden layout	
✓2.Start points	
✓3.Test start points	
4.Work timer	

4-2

Select [1. Auto fill up timer] or [2. Manual setup] and press the  button.

Menu name	Description
[1.Auto fill up timer]	For automatically calculating the minimum required dates of the week referring to the boundary wire length and garden size.
[2.Manual setup]	For manually setting the work day and work time to operate the lawnmower. You can configure the proper settings with your garden.


Work timer	4/4
Recommended	10hrs/week
1.Auto fill up timer	
2.Manual setup	

If you select [1.Auto fill up timer], go to step 4-3.
If you select [2.Manual setup], go to step 4-5.

NOTE:

- If you do not know the details on the work timer settings, select [1.Auto fill up timer], or contact your dealer.
- For details on the work timer settings, see “4. MENU SETTINGS” (page 44).
- According to the mowing results with the settings which are automatically configured by the system, it may be necessary to adjust the values for operating the lawnmower. If you do not know the details on the settings, contact your dealer.

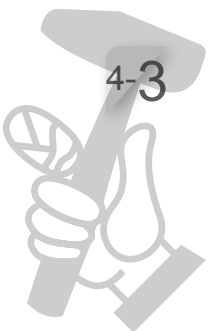
4-3

Select the preferred time for when the lawnmower should automatically operate. After selecting, select [NEXT] and press the  button.

[Day]: Operates mostly in the morning or afternoon.

[Night]: Operates mostly at night.

Work timer	4/4
Preferred mowing time	
<input checked="" type="checkbox"/> Day	
<input type="checkbox"/> Night	
	NEXT



4-4

Confirm the days which are automatically selected referring to the boundary wire length and garden size. Select [NEXT] and press the button to proceed to the timer setting screen.

NOTE:

- You can select other days to operate the lawnmower.

4-5

If you select [1.Auto fill up timer] in step 4-2, confirm the days which are automatically configured referring to the boundary wire length and garden size.

If you do not change the setting, select [OK] and press the button.

Go to step 4-11.

If you want to change the work time, select the day and press the button to change the work time of the lawnmower.

If you do not want to change the work time, select [OK] and press the button.

Go to step 4-7.

If you select [2.Manual setup] in step 4-2, select the day and press the button to change the work time of the lawnmower.

4-6

Enter a start time and an end time in 24-hour format for [1]. If you want to split the day into two work times, also enter a start time and an end time in 24-hour format for [2].

NOTE:

- If selecting [Copy to week] and pressing the button, you can copy the settings to the other days. For details on this operation, see "4 MENU SETTINGS" (▣ page 44).

4-7

To reset the working day, press the button. Return to step 4-4.

4-8

Select [OK] and press the button.

4-9

If desired, select start points to be used each day by pressing the button to select the day.

NOTE:

- The check boxes which you configured in [2.Start points] are displayed.
 - When you are finished, select [NEXT] and press the button.
 Go to step 4-11.

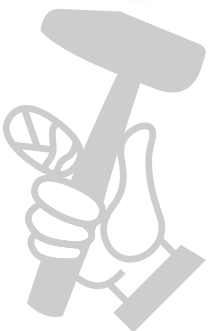
Work timer		4/4
Minimum days required 7		
<input type="checkbox"/> All	<input checked="" type="checkbox"/> MON	<input checked="" type="checkbox"/> TUE
<input checked="" type="checkbox"/> WED	<input checked="" type="checkbox"/> THU	<input checked="" type="checkbox"/> FRI
<input checked="" type="checkbox"/> SAT	<input checked="" type="checkbox"/> SUN	NEXT


OK	0	6	12	18	24
MON			<input checked="" type="checkbox"/>	<input checked="" type="checkbox"/>	
TUE			<input checked="" type="checkbox"/>	<input checked="" type="checkbox"/>	
WED			<input checked="" type="checkbox"/>	<input checked="" type="checkbox"/>	
THU			<input checked="" type="checkbox"/>	<input checked="" type="checkbox"/>	
FRI			<input checked="" type="checkbox"/>	<input checked="" type="checkbox"/>	
SAT			<input checked="" type="checkbox"/>	<input checked="" type="checkbox"/>	
SUN			<input checked="" type="checkbox"/>	<input checked="" type="checkbox"/>	


Work timer		4/4
Monday		
1	From	to
	9 : 0 0	- 1 2 : 0 0
2	From	to
	1 4 : 0 0	- 1 8 : 0 0
Copy to week		

OK	Timer1	Timer2
MON	<input checked="" type="checkbox"/> <input checked="" type="checkbox"/>	
TUE	<input checked="" type="checkbox"/> <input checked="" type="checkbox"/>	<input checked="" type="checkbox"/> <input checked="" type="checkbox"/>
WED	<input checked="" type="checkbox"/> <input checked="" type="checkbox"/>	
THU	<input checked="" type="checkbox"/> <input checked="" type="checkbox"/>	<input checked="" type="checkbox"/> <input checked="" type="checkbox"/>
FRI	<input checked="" type="checkbox"/> <input checked="" type="checkbox"/>	
SAT	<input checked="" type="checkbox"/> <input checked="" type="checkbox"/>	<input checked="" type="checkbox"/> <input checked="" type="checkbox"/>
SUN	<input checked="" type="checkbox"/> <input checked="" type="checkbox"/>	<input checked="" type="checkbox"/> <input checked="" type="checkbox"/>

Set start points	
Monday	
1	1 2 3 4 5
	<input checked="" type="checkbox"/> <input checked="" type="checkbox"/>
2	1 2 3 4 5
NEXT	




4-10 Select [OK] and press the  button.

4-11 Confirm the achieved and recommended hours per week. Select [NEXT] or [No] and press the  button.
If you select [NEXT], go to step 4-12.
If you select [No], go to step 4-5.

NOTE:

- If the set time is shorter than the [Recommended] time, the Achieved value will blink.

Work timer	4/4
Achieved	10hrs/week
Recommended	10hrs/week
No	NEXT

4-12 Select [1. Regional setup] or [2. Deactivate] and press the  button.

NOTE:

- The growth speed of a lawn depends on the season and weather conditions. With this function you can set the ratio of the work timer as season and weather conditions change.

Work timer	4/4
Seasonal timer	
1.Regional setup	
2.Deactivate	


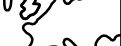


Menu name	Description
[1. Regional setup]	Select your region and set the mowing time ratio for each month.
[2. Deactivate]	Do not set a seasonal timer. lawnmower will mow at 100% of the work timer that you have set.

If you select [1.Regional setup], go to step 4-13.
If you select [2. Deactivate], go to step 4-15.

NOTE:

- The lawnmower may not operate correctly under the following conditions even when seasonal timer is set.
 - The blades are worn out.
 - Dirt and cut grass have accumulated in the working parts such as the blade disc.
 - The work timer has not been set for a long enough period to mow the entire lawn.
 - There are obstacles such as branches and rocks on the lawn.

4-13 Select your region and press the  button.

Seasonal timer	
Select your region.	
1.North	
2.North Central	
3.South Central	
4.South	




4-14 Confirm each month's ratio, select [NEXT].


NOTE:

- You can modify the values for operating the lawnmower.
- According to the mowing results with the settings which are automatically configured by the system, it may be necessary to adjust the values for operating the lawnmower. If you do not know the details on the settings, contact your dealer.

Seasonal timer							
JAN	0	0	0 %	JUL	1	0	0 %
FEB	0	0	0 %	AUG	1	0	0 %
MAR	0	4	0 %	SEP	0	8	0 %
APR	0	6	0 %	OCT	0	4	0 %
MAY	0	8	0 %	NOV	0	0	0 %
JUN	1	0	0 %	DEC	0	0	0 %
NEXT							

4-15 Press the  button. Setup wizard top screen is displayed and [4.Work timer] is checked.


Setup wizard	4/4
<ul style="list-style-type: none"> ✓1.Garden layout ✓2.Start points ✓3.Test start points ✓4.Work timer 	Finish

4-16 Select [Finish] and press the  button. Setup wizard top screen is displayed and [4.Work timer] is checked. Initial setup complete screen is displayed.

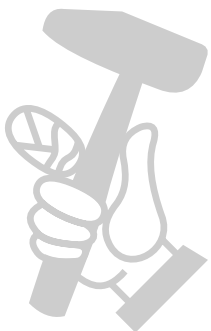
NOTE:

- If you want to modify the settings in this menu, select this menu again. You can configure the settings through the setup wizard.

Setup wizard	4/4
<ul style="list-style-type: none"> ✓1.Garden layout ✓2.Start points ✓3.Test start points ✓4.Work timer 	Finish

4-17 If you don't need the advanced setup, select [Finish] and press the  button. Initial setup is completed and Home screen is displayed.

Select install menu
<ul style="list-style-type: none"> 1.Setup wizard 2.Advanced setup 3.Restart initial setup
Finish



■ Configuring the settings through the advanced setup

The advanced setup will guide you to configure the settings for your mowing operation as follows:

Menu name	Settings
[1. Mowing settings] NOTE: - Making the detailed setting can reduce uncut leaves and cut efficiently.	- Mowing pattern - Wire overlap - Edge cutting - Spiral cutting
[2. Quiet timer] NOTE: - You can adjust the speed of the operation and the blade. This is useful when you want to reduce the operating noise of the machine, such as late at night.	- Blade speed - Wheel speed - Timer

1. Mowing setting

1-1

Select [1. Mowing settings] or [2. Quiet timer].

If you select [Mowing settings], go to step 1-2.

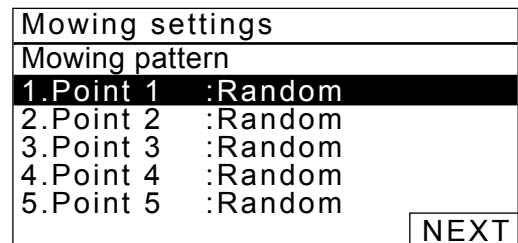
If you select [Quiet timer], go to step 2-1.



1-2

Select a start point and press the \ominus button.

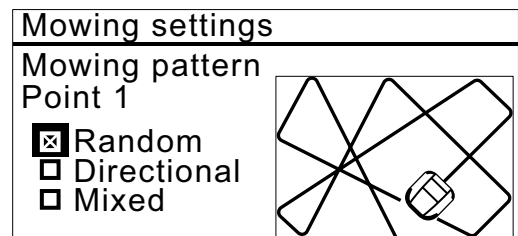
If you select [NEXT], go to step 1-4.



1-3

You can select [Random], [Directional], or [Mixed] for the mowing pattern.

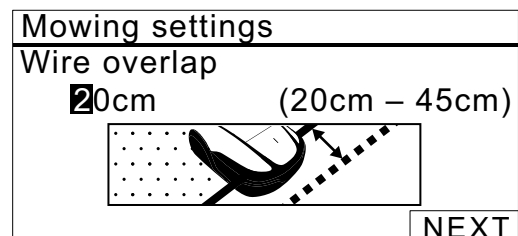
If you select [OK], and press the \ominus button, you will be returned to the screen in step 1-2.



1-4

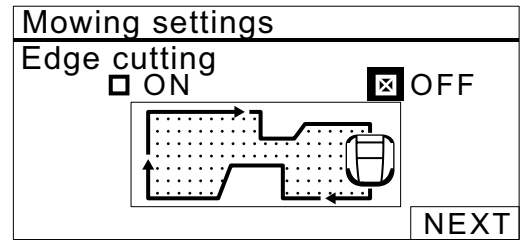
Enter the value from 20 to 45 (cm).

Select [NEXT] and press the \ominus button.



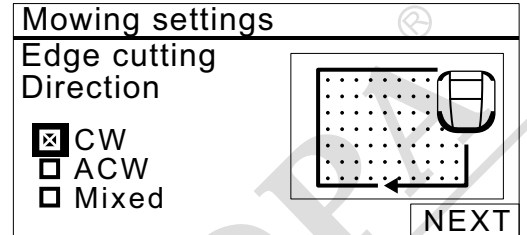
1-5

Select [ON] or [OFF] and press the button.
If you select [ON], go to step 1-6.
If you select [OFF], go to step 1-8.



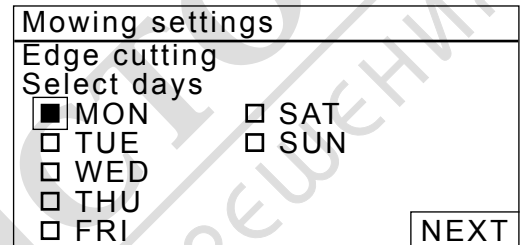
1-6

Select [CW], [ACW], or [Mixed] for the edge cutting direction.
Select [NEXT] and press the button.



1-7

Select the day of the week on which you want the lawnmower to run with the edge cutting function, and press the button.
Select [NEXT] and press the button.
You can select up to two workdays per week.

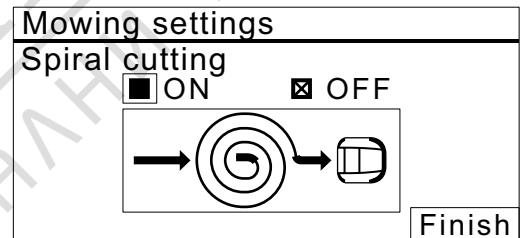


1-8

Select [ON] or [OFF] and press the button.
If you select [Finish] and press the button, you will be returned to the screen in step 1-1.

NOTE:

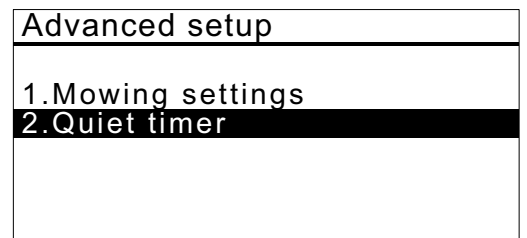
- For details on the Spiral cutting, see "Spiral cutting" (page 60).



2. Quiet timer

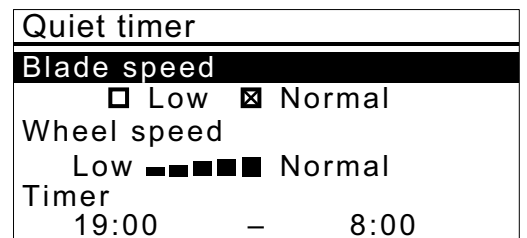
2-1

Select [2.Quiet timer] and press the button.



2-2


[Blade speed]: Select [Low] or [Normal] for the lawnmower blade speed by pressing the buttons.
Press the button.





2-3

[Wheel speed]: Configure the wheel speed level with which you want the lawnmower to operate by pressing the buttons.
Press the button.

2-4

[Timer]: Enter a start time and end time in 24-hour format using the number buttons.
Press the  button.

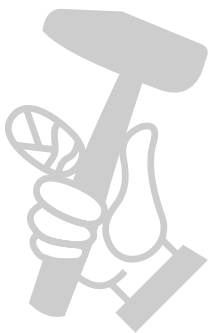
2-5

Press the  button.
If you select [Finish] and press the  button, you will be returned to the home screen.

Select install menu

- 1.Setup wizard
- 2.Advanced setup
- 3.Restart initial setup

 Finish



МАГАЗИН
БАШ МАЙСТОРА
ПРОФЕСИОНАЛНИ РЕШЕНИЯ

4 MENU SETTINGS


The control panel menus are used to set how the lawnmower operates. The menu settings can also be accessed in Mii-monitor. You can use Mii-monitor to save the settings. You can also restore saved settings.

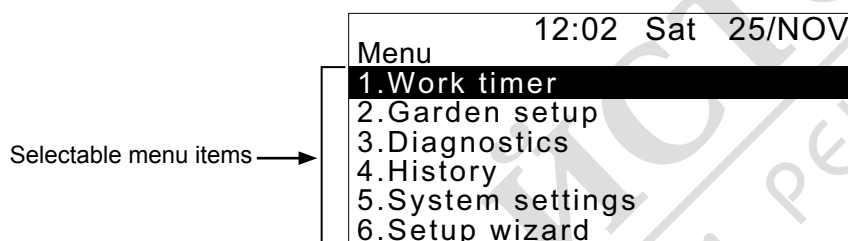
Menu overview

NOTE:

- We recommend having your dealer change these settings during installation.

Menu screen

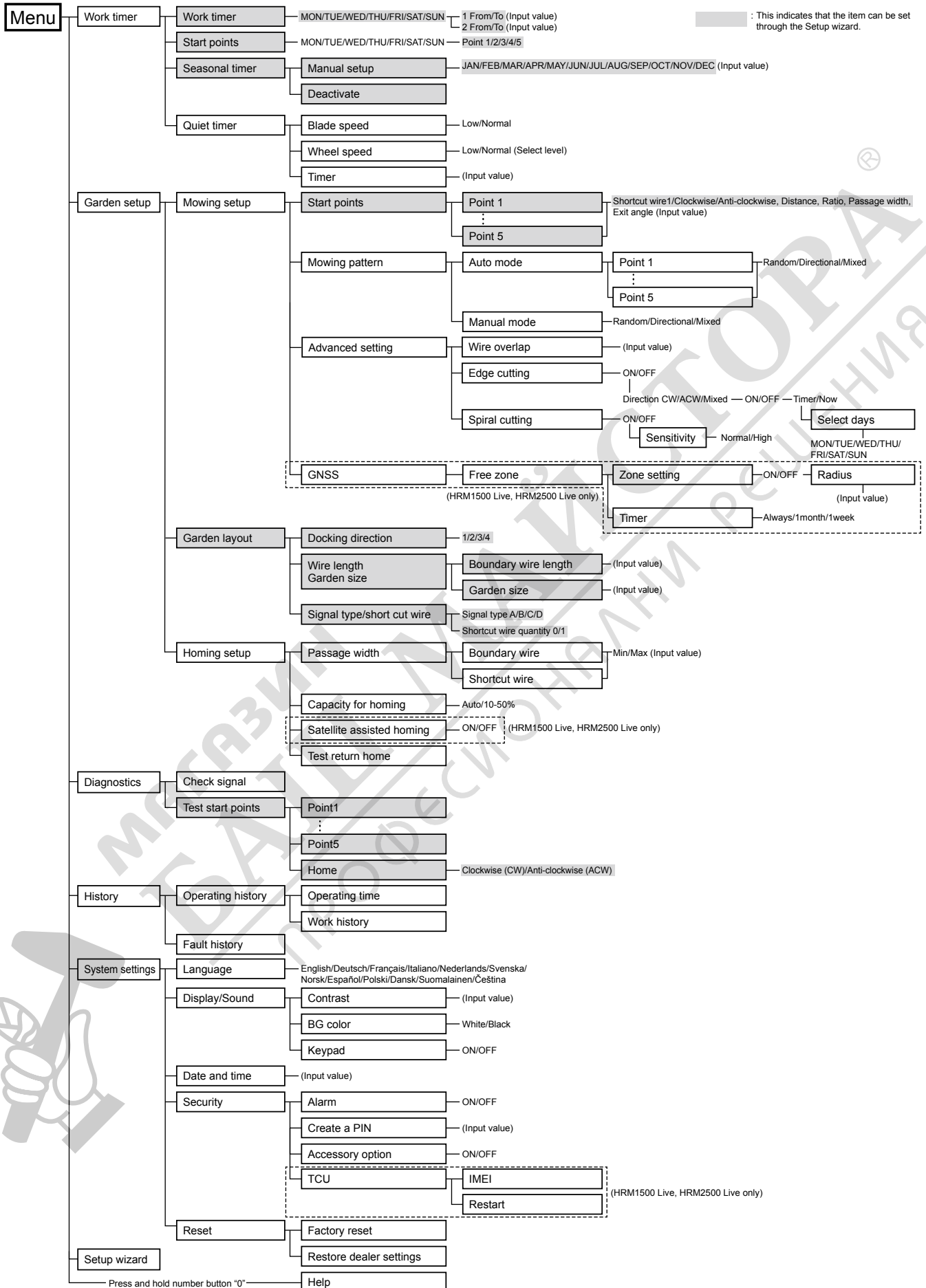
Selecting [Menu] in the home screen and press the  button, Menu screen is displayed as below:



The menu consists of multiple levels of submenus. The uppermost levels are as follows:

Menu name	Usage	See this page for information
[1.Work timer]	For setting the work day and work time, and selecting the start points.	(☞ page 46)
[2.Garden setup]	For configuring the lawnmower to operate.	(☞ page 52)
[3.Diagnostics]	For diagnosing the lawnmower.	(☞ page 68)
[4.History]	For viewing operation and error history.	(☞ page 71)
[5.System settings]	For configuring system-related settings.	(☞ page 74)
[6.Setup wizard]	For configuring the setting through the set up wizard according to the steps of the screens.	(☞ page 31)

Full menu diagram



Setting the work timer

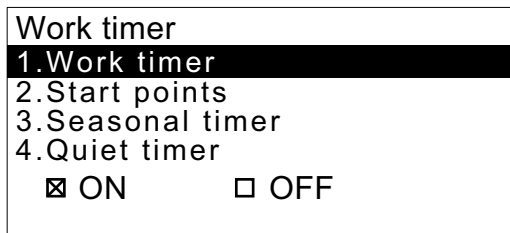
You can set the work day and work time for the lawnmower to operate. You can also specify a specific area point to start from for each work time.

Work timer

You can select the day and time on which you want the lawnmower to operate.



Home screen → Menu screen → [1.Work timer] → [1.Work timer]



Configure this setting to have the lawnmower operate on specific days and times.

You can set up to two times for operation for one day.

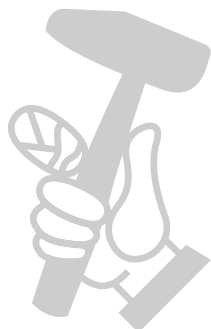
NOTE:

- The [Timer 1] cannot be overlapped with the [Timer 2].
- The period of time cannot include "00:00".

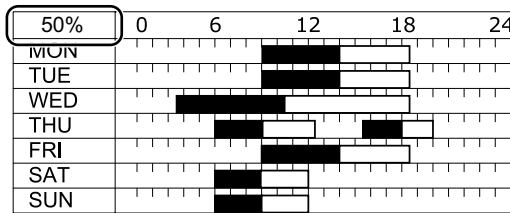
- 1 Select the day on which you want the lawnmower to operate.
- 2 Press the button to proceed to the timer setting screen.
- 3 Enter a start time and an end time in 24-hour format for [Timer 1] using the number buttons.
- 4 If necessary, also enter a start time and an end time in 24-hour format for [Timer 2].

NOTE:

 - If you want to copy the work timer settings to the other days of week, select [Copy to week] and the button.
- 5 Press the button to return to the previous screen.



The percentage which is configured in the seasonal timer is the ratio in which the lawnmower works in a month. For details on the seasonal timer, see "Seasonal timer" (page 49).



Confirm the period of work time for each day of week.

NOTE:

- Black part in the bar is the time in which the lawnmower will work. White part in the bar is the time in which lawnmower will not work. The ratio of black and white parts depends on the settings of seasonal timer. For details on the seasonal timer, see "Seasonal timer" (page 49).

Set the time.

Work timer

Monday

1 From 9:00 to 12:00

2 From 14:00 to 15:00

Copy to week

If you want to copy the work timer settings to the other days of week, select [Copy to week] and the button.

Work timer

Select days to copy

All MON TUE

WED THU FRI

SAT SUN

Yes No

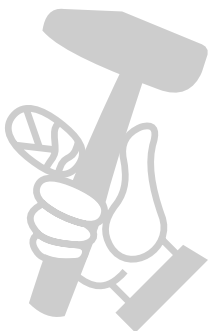
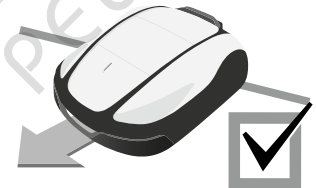
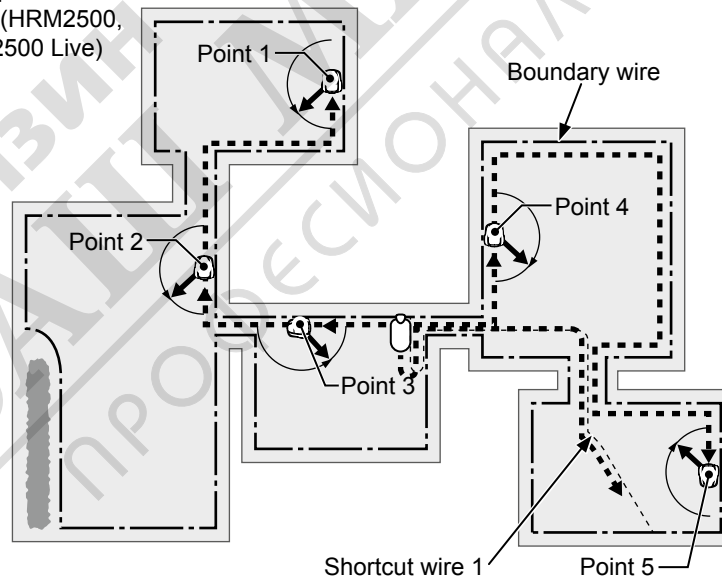
Select each box of the day to which you want to copy and press the button.

After adding checks to the boxes, select [Yes] and press the button to copy the settings to the selected days of week.

Start points

You can set the start points for each day of week. For example, if you set the following 5 start points (HRM2500, HRM2500 Live) in your garden, you enable the lawnmower to reach other areas through narrow passages for a better efficiency.

Example: 5 start points (HRM2500, HRM2500 Live)



Menu screen





 Home screen → [1. Work timer] → [2. Start points]

Configure this setting to make the lawnmower start mowing from specific start points on specific days of week.

You can configure the following start points for each model:

HRM1000, HRM1500, HRM1500 Live: 3 start points

HRM2500, HRM2500 Live: 5 start points

- 1 Select the day and press the  button.
- 2 Add a check to the box by pressing the  button to select the start points. Select [NEXT] and press the  button.
- 3 Press the  button to return to the previous screen.

By setting the start points for each day of week, you can effectively operate the lawnmower to mow your garden such as below:

TIPS The items set in “Start point” in “Setup wizard” are displayed.

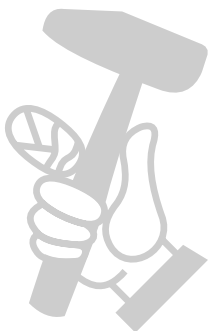
	Timer1	Timer2
MON	1 2 3	
TUE	1 2 3	
WED	1 2 3	
THU		3 4 5
FRI		3 4 5
SAI		
SUN		

From Monday to Wednesday: the lawnmower starts mowing from point 1, point 2, or point 3.

From Thursday to Friday: the lawnmower starts mowing from point 3, point 4, or point 5.

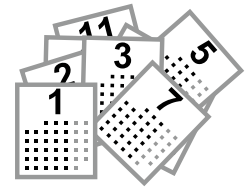
Start points	
Monday	
1	<input checked="" type="checkbox"/> 1 <input checked="" type="checkbox"/> 2 <input checked="" type="checkbox"/> 3 <input type="checkbox"/> 4 <input type="checkbox"/> 5
2	<input type="checkbox"/> 1 <input type="checkbox"/> 2 <input type="checkbox"/> 3 <input type="checkbox"/> 4 <input type="checkbox"/> 5
NEXT	

Checkboxes are displayed only for configured start points. (In this example, 5 start points are configured.)




■ Seasonal timer

The growth speed of lawn depends on the season. With this function, you can configure the ratio of the mowing time for each season.



● Manual setup

 Home screen → ^{Menu screen} [1.Work timer] → [3.Seasonal timer] → [1.Manual setup]

Seasonal timer	
1.Manual setup	<input checked="" type="checkbox"/>
2.Deactivate	<input type="checkbox"/>

Configure this setting to have a percentage of each month of lawnmower operation.

1

Select your region and press the  button.

2

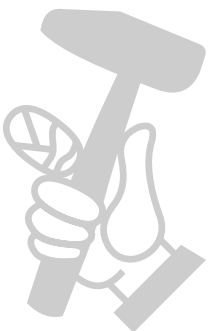
Enter a percentage of each month using the number buttons.

3


Select [OK] and press the  button to return to the previous screen.

Seasonal timer			
JAN	0 2 0 %	JUL	1 0 0 %
FEB	0 5 0 %	AUG	1 0 0 %
MAR	1 0 0 %	SEP	0 9 0 %
APR	1 0 0 %	OCT	0 8 0 %
MAY	1 0 0 %	NOV	0 6 0 %
JUN	1 0 0 %	DEC	0 4 0 %
			OK

Set the ratio of the mowing time for each month.
Example: If the work time in February is set to 50% and the work timer for one day is 10 hours, the mowing time for one day will be 5 hours.



● Deactivate

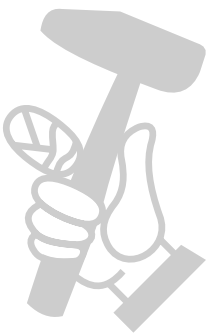
 **Home screen** → Menu screen → **[1.Work timer]** → **[3.Seasonal timer]** → **[2.Deactivate]**

Seasonal timer	
1.Manual setup	<input type="checkbox"/>
2.Deactivate	<input checked="" type="checkbox"/>

You can deactivate the timer for each season for operating the lawnmower.
If the seasonal timer is deactivated, the lawnmower works 100% for each month.

1

Select [OK] and press the  button to return to the previous screen.



Quiet timer

You can set the blade speed, wheel speed and timer for operating the lawnmower quietly.



Home screen → **Menu screen** → [1.Work timer] → [4.Quiet timer] (“ON” is checked)

Configure this setting to operate the lawnmower with low noise during the period which you configure.

1

Select [Blade speed] and press the button.

If you want the lawnmower to mow on your lawn quietly, select [Low].

2

Press the button.

3

Select [Wheel speed] and configure the wheel speed level with which you want the lawnmower to operate by pressing the up/down arrow buttons.

4

Press the button.

5

Select [Timer] and enter a start time and an end time in 24-hour format using the number buttons.

6

Press the button.

7

Press the button to return to the previous screen.

Configure the blade speed of the lawnmower.

Set a start time and an end time for configuring the time for the quiet operation.

Quiet timer		
Blade speed	<input type="checkbox"/> Low <input checked="" type="checkbox"/> Normal	
Wheel speed	Low Normal	
Timer	19:00	8:00

Configure the wheel speed of the lawnmower.

TIPS Decreasing the wheel speed may reduce the travel distance in the set period and leave more grass uncut. In that case, extend the working.



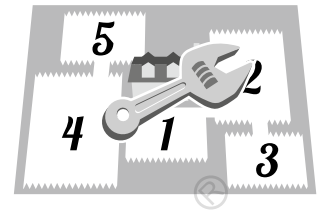
Setting the lawnmower operation

Mowing setup

You can set up the Mowing settings as follows:

NOTE:

- Shortcut wire is not available on the HRM1000.



Setting the angle to turn from the boundary wire or the shortcut wire

When leaving the boundary wire, set the angle to turn from the boundary wire.

🔍 *Angle settings in [1.Start points] (☞ page 55)*

- Set the angle of departure for when the lawnmower arrives at the position specified by the angle of [1.Start points].

Setting the distance to the start point

Until the lawnmower reaches a set starting point in an area, it will run without mowing.

🔍 *Distance settings in [1.Start points] (☞ page 55)*

- Sets the distance from the docking station to start cutting.

Setting the overlap distance on the boundary wire

Set the distance that the lawnmower can cross the boundary wire.

🔍 *[1.Wire Overlap] (☞ page 57)*

NOTE:

- To have the lawnmower smoothly turn from the boundary wire, the recommended value of the Wire overlap is 20 cm.

Example: 5 start points (HRM2500, HRM2500 Live)

Setting the starting direction from the docking station

Set whether the lawnmower should travel clockwise or anti-clockwise along the boundary wire to reach a set starting point. If the shortcut wire is installed, the shortcut wire can be selected in addition to the boundary wire.

🔍 *S1(Shortcut wire 1), ⌚ (Clockwise) or ⌚ (Anti-clockwise) in [1.Start points] (☞ page 55)*

Setting the operation ratio of each area operation

Set an area operation ratio if you want to mow more frequently from a certain start point.

For example, if you set the ratio for "Point 1" to 30%, the lawnmower will start mowing 3 times out of 10 from "Point 1" and 7 times out of 10 from other start points.

🔍 *Percentage settings in [1.Start points] (☞ page 55)*

NOTE:

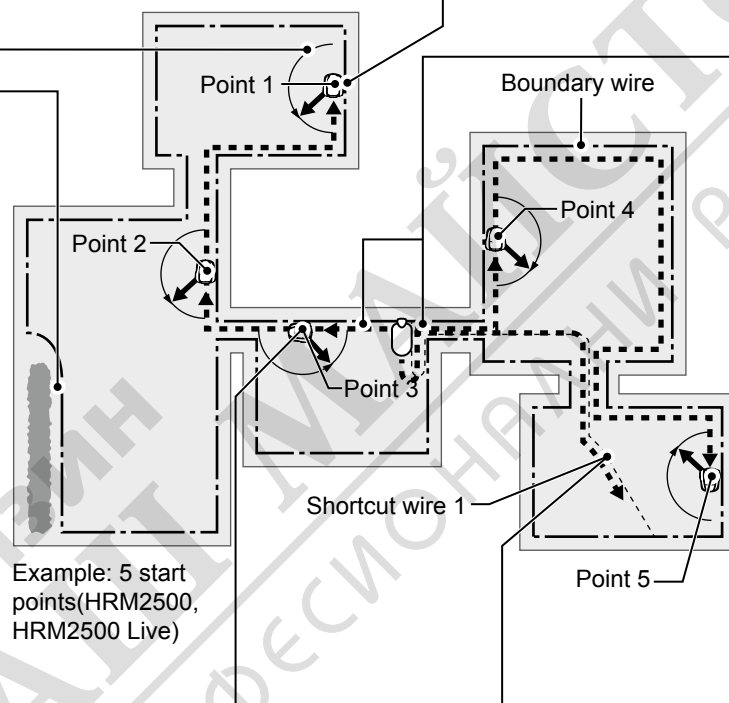
- You can configure 3 start points (HRM1000, HRM1500, HRM1500 Live) or 5 start points (HRM2500, HRM2500 Live).

NOTE:

- If you want to operate the lawnmower with the Auto mode, see "Operating the lawnmower in the Auto mode." (☞ page 89)

Installing and setting the shortcut wire

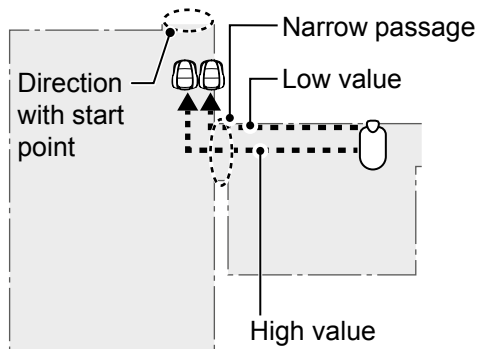
Install the shortcut wire if you want to shorten the time to reach the mowing start point and return to the charging station. The lawnmower traces the shortcut wire and suppresses the occurrence of wheel tracks.



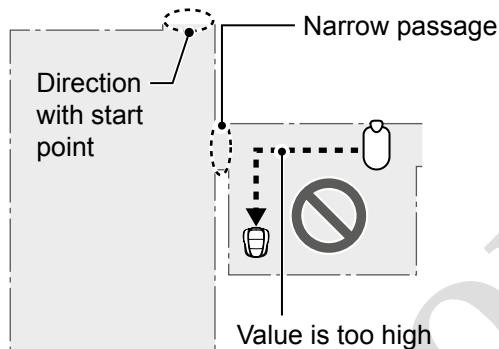
Distance from the boundary wire when the lawnmower goes toward the mowing start points:

The lawnmower moves between the boundary wire and the shortcut wires, and the specified value at random as it goes toward the start point.

When setting the proper passage width



When the passage width is set too high



NOTE:

- When the value is too high, lawnmower may not pass through narrow passage.
Laying the shortcut wire is effective when the lawnmower passes through narrow passages. (HRM1500, HRM1500 Live, HRM2500, HRM2500 Live)

Boundary wire passage width sample table

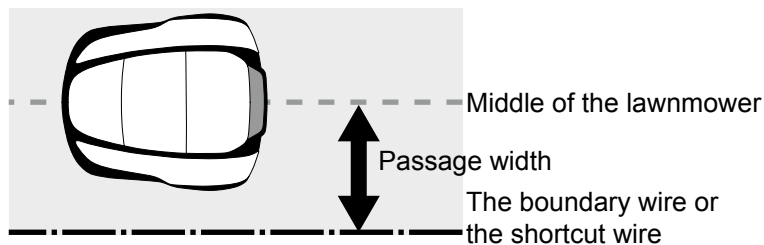
Boundary wire

Setup level	Passage width
0	10 cm
1	25 cm
2	30 cm
3	35 cm
4	40 cm
5	50 cm
6	60 cm
7	70 cm
8	80 cm
9	90 cm
10	100 cm
11	110 cm
12	130 cm

Shortcut wire

Setup level	Passage width
1	25 cm
2	30 cm
3	35 cm
4	40 cm
5	50 cm
6	60 cm
7	70 cm
8	80 cm
9	90 cm
10	100 cm
11	110 cm
12	130 cm

Passage width: From wire to middle of the lawnmower



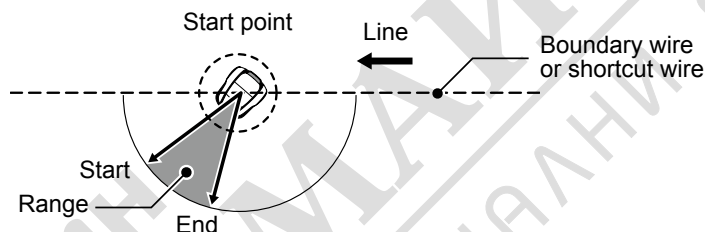
NOTE:

- The field strength varies depending on the length of the boundary wire and the shortcut wire. The field becomes weaker with a longer wire, and stronger with a shorter wire.
- When the range of values are high (by avoiding moving along the same path), you can avoid creating wheel tracks in the grass.
- The numerical values of this table are for reference to return the lawnmower to the docking station along a straight line.
- The numerical values may differ depending on the actual conditions.

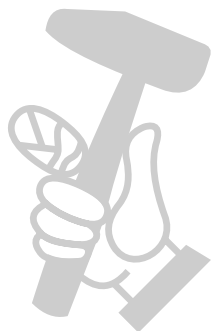
The angle at which the lawnmower departs from the wire:

The lawnmower travels to the start points along the boundary wire or the shortcut wire, and then turns away from the wire to start mowing.

You can configure the angle (range) at which the lawnmower deviates from the boundary wire or the shortcut wire when it starts mowing as below (Default value is from 10° to 170°):



TIPS Use the exit angle to let the lawnmower reach the mowing areas directly instead of using long wire exit locations.



● Start points

Menu screen

Home screen → [2.Garden setup] → [1.Mowing setup] → [1.Start points] → [1.Point 1] to [3.Point 3] (HRM1000, HRM1500, HRM1500 Live) or [5.Point 5] (HRM2500, HRM2500 Live)

Menu
1.Work timer
2.Garden setup
3.Diagnostics
4.History
5.System settings
6.Setup wizard

12:02 Sat 25/NOV
Garden setup
1.Mowing setup
2.Garden layout
3.Homing setup

12:02 Sat 25/NOV
Mowing setup
1.Start points
2.Mowing pattern
3.Advanced setting
4.GNSS

The lawnmower travels to this location along the boundary wire or the shortcut wire, and then turns away from the boundary wire or the shortcut wire to begin mowing. By setting the start point, you can start mowing from the desired area.

TIPS Do not make the distance value longer than it needs to be. This will shorten the cutting time.

HRM1500, HRM1500 Live, HRM2500, HRM2500Live:

At the start point using the shortcut wire, the lawnmower will start work from the point where it joins the boundary wire, so by setting the distance of the start point longer than the shortcut wire, you can start work from the connection point of the shortcut wire.

1

Select S1(Shortcut wire 1), ⌚ (Clockwise), ⌚ (Anti-clockwise) enter the values of the distance from the docking station to start cutting, and enter a percentage of the ratio which the lawnmower operates.

2

Select [NEXT] and press the ⏪ button.

3

Enter the values of the width setting and angle, and press the ⏪ button.

NOTE:

- By selecting [TEST], you can check the settings of each start point before mowing. For details, see "Test start points" (page 69).

4

Press the ⏩ button to return to the previous screen.

Set whether the lawnmower should travel clockwise or anti-clockwise along the boundary wire and the shortcut wire to reach a start point.

Start points		
Point	S1 / ⌚ / ⌚	(0.700m)
1	□ / ☒ / □	0 m
2	□ / ☒ / □	0 m

Sets the distance from the docking station to start cutting.


Set an area operation ratio if you want to mow more frequently from a certain start point. Set so that the total of all the percentages is 100%.

Sets the minimum and maximum distance between the lawnmower and the boundary wire when following the boundary wire or the shortcut wire.

Start points		
Point	Width	Angle
1	3 - 10	10 - 170
2	3 - 10	10 - 170
3	3 - 10	10 - 170
4	3 - 10	10 - 170
5	3 - 10	10 - 170
TEST	(- 12)	(10' - 170')

When leaving the boundary wire or the shortcut wire, set the minimum and maximum angle to turn from the wire.

● Mowing pattern


Home screen → Menu screen **[2.Garden setup]** → **[1.Mowing setup]** → **[2.Mowing pattern]** → **[1.Auto mode]** → **[1.Point 1] to [5.Point 5]**

You can select from 3 mowing patterns below:

[Random]
With the **[Random]** setting, when the lawnmower detects the boundary wire, it turns at a wide angle. This is the most effective for mowing a large open area of grass. For normal operation, use this setting.

[Directional]
With the **[Directional]** setting, when the lawnmower detects the boundary wire, it turns at a narrow angle. This is used for mowing narrow areas.

[Mixed]
With the **[Mixed]** setting, the lawnmower alternates between the **[Random]** mowing pattern and the **[Directional]** mowing pattern at regular intervals.

NOTE:

- Select [1.Auto mode] to set or change the mowing patterns for each point.
To manually set or change the mowing pattern, see “Operating the lawnmower in the Manual mode”(☞ page 90).

You can adjust how the lawnmower moves while mowing.
With the [Mixed] setting, the lawnmower alternates between random mowing and directional mowing in approximately 15-minute intervals.

1

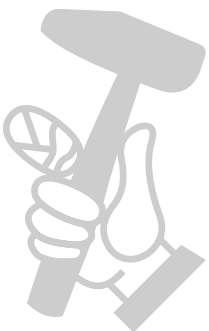
Select [Random], [Directional] or [Mixed].

2

Press the ⏪ button.

3

Press the ⏩ button to return to the previous screen.



● Advanced setting

• Wire overlap

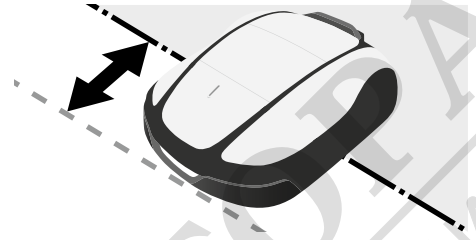
 **Home screen** → Menu screen **[2.Garden setup]** → **[1.Mowing setup]** → **[3.Advanced setting]** → **[1.Wire overlap]**

When the lawnmower detects the boundary wire, it can slightly cross the boundary to mow the outer edges of the mowing area. You can adjust how far it crosses the boundary wire.

NOTE:

- It is better to use default 20 cm setting for smoothly turning on the boundary wire.

Wire overlap: From boundary wire to front of the lawnmower.

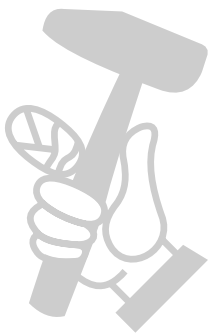


1

Enter a value from 20 to 45 (cm).

2

Press the  button.

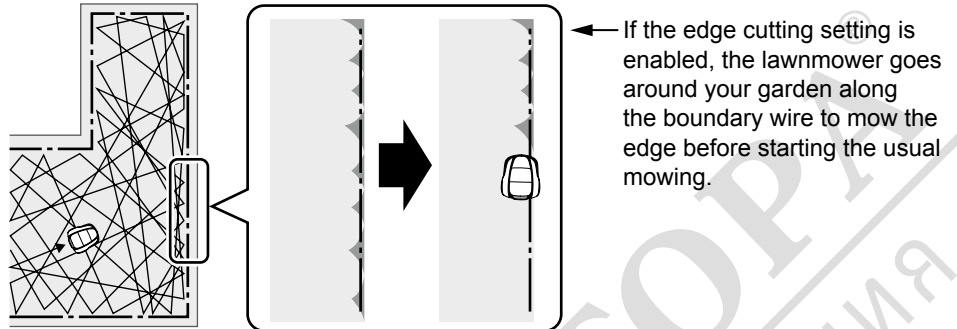


МАГАЗИН МАЙСТРА
БАШ МАЙСТРА
ПРОФЕСІОНАЛНИ РЕШЕННЯ

• Edge cutting

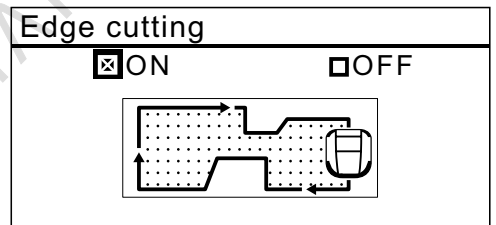
 **Home screen** → **[2. Garden setup]** → **[1. Mowing setup]** → **[3. Advanced setting]** → **[2. Edge cutting]**

With this function, you can mow the unmown area along the boundary wire.

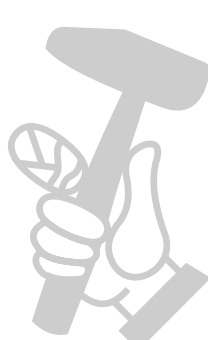
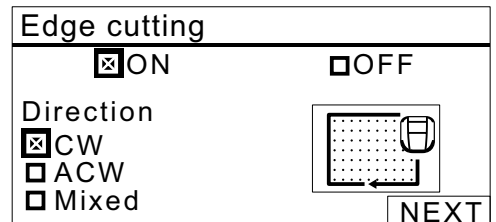


If you set this function on, the lawnmower mows along the boundary wire when the work timer starts for the first time on selected day(s). You can also configure the day(s) of the week on which you want the lawnmower to mow along the boundary wire (2 days per week maximum).


1 Select **[ON]** or **[OFF]** for configuring the edge cutting, and press the **⏪** button. If select **[ON]**, go to step 2. The unmown part along the boundary wire will be neatly-mowed. If select **[OFF]**, you will return to the previous screen. You can select **[OFF]** to operate the lawnmower with reduced battery consumption.

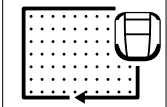


2 Select **[CW]**, **[ACW]**, or **[Mixed]** for the edge cutting direction. Then select **[NEXT]** and press the **⏪** button.
 [CW]: Proceed clockwise
 [ACW]: Proceed anti-clockwise
 [Mixed](Auto mode only): Alternate between CW and ACW
 If the lawnmower is set to the Auto mode, go to step 3-1.
 If the lawnmower is set to the Manual mode, go to step 3-2.



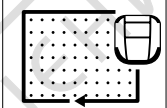
3-1

Select [ON] and press the  button.
[Timer] is set. Go to step 4.


Edge cutting	
<input checked="" type="checkbox"/> ON	<input type="checkbox"/> OFF
<input checked="" type="checkbox"/> Timer	

3-2

Select [ON] and press the  button.
After setting, immediately start edge cutting.
Go to step 5.

Edge cutting	
<input checked="" type="checkbox"/> ON	<input type="checkbox"/> OFF
<input checked="" type="checkbox"/> Now	

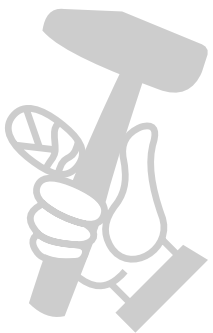
4

Select the day of the week on which you want the lawnmower to run with the edge cutting function, and press the  button.
You can select up to two workdays per week.

Edge cutting	
12:02 Sat 25/NOV	
Select days	
<input checked="" type="checkbox"/> MON	<input type="checkbox"/> SAT
<input type="checkbox"/> TUE	<input type="checkbox"/> SUN
<input type="checkbox"/> WED	
<input type="checkbox"/> THU	
<input type="checkbox"/> FRI	<input type="button" value="Finish"/>

5

Select [Finish] and press the  button.

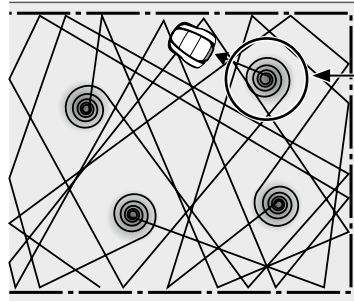


МАГАЗИН
БАШ
ПРОФЕСИОНАЛ

• Spiral cutting

 **Home screen** → Menu screen **[2.Garden setup]** → **[1.Mowing setup]** → **[3.Advanced setting]** → **[3.Spiral cutting]**


With this function, the lawnmower can be focused on mowing the area where the lawn is not completely mown, or the growth speed of the lawn is fast.

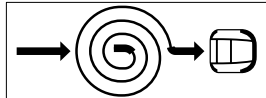


The lawnmower detects the dense area and mow there spirally.

With this function, you can concentrate the lawnmower on mowing the dense area of lawn during the normal operation.

1

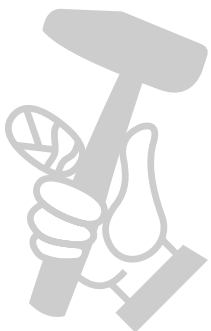
Select **[ON]** or **[OFF]** for configuring the spiral cutting, and press the  button. You can select **[OFF]** to operate the lawnmower with reduced battery consumption.

Spiral cutting	
<input type="checkbox"/> ON	<input checked="" type="checkbox"/> OFF
	

2

Select **[Normal]** or **[High]** for configuring the sensitivity, and press the  button.

Spiral cutting	
<input checked="" type="checkbox"/> ON	<input type="checkbox"/> OFF
Sensitivity	
<input type="checkbox"/> Normal	<input checked="" type="checkbox"/> High



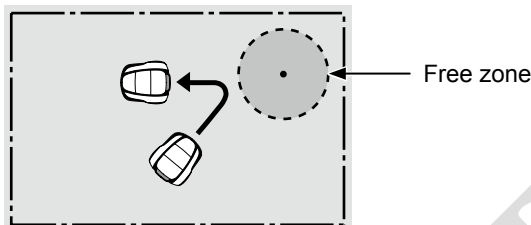
● GNSS (HRM1500 Live, HRM2500 Live only)

NOTE:

- GNSS is an abbreviation for Global Navigation Satellite System. Position information can be obtained from satellites.

 **Home screen** → **[2.Garden setup]** → **[1.Mowing setup]** → **[4.GNSS]** → **[1.Free zone]**

With this function, you can set a location that you do not want the lawnmower to mow in.



To activate the configuration, it will take effect once the specified requirements are met.

- The lawnmower must be able to receive GPS signals.
- The free zone must be set.

Narrow passages, complex yards with many obstacles, and low GNSS sensitivity (behind buildings and trees) can cause:

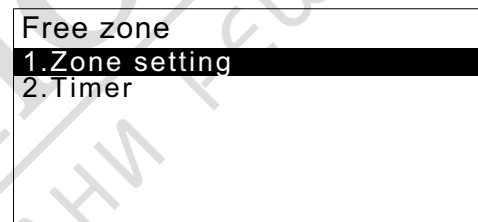
- The lawnmower intrudes into the free zone.
- The lawnmower performs evasive action (renewal, turning) in front of the free zone.

Free zone can be set in one place. If you want to make a new place, set the zone setting again.

Free zone settings can be easily configured with the Mii-monitor application.

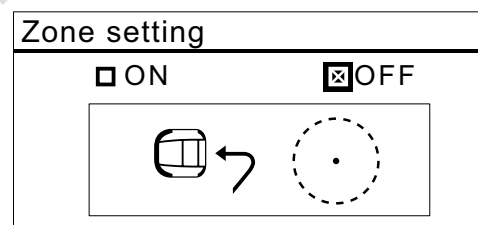
1

Select **[1.Zone setting]** and press .




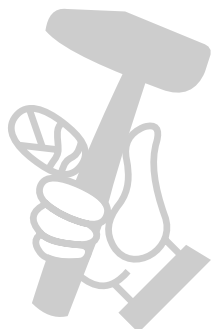
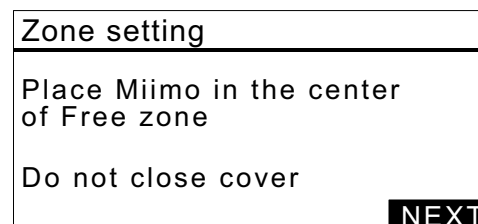
2

Select **[ON]** and press the .




3


Place the lawnmower in the center of the free zone to be set, and press the .




4

Enter the radius of the free zone to be set from 3 to 20m. Select [OK] and press the  button.

[Please wait for 10 seconds.] is displayed.

Zone setting	
Radius	
■	_m
(3-20m) 	
NEXT	

5

[Finish] is displayed, press the  button. The following screen is displayed.

Mowing setup
1.Start points
2.Mowing pattern
3.Advanced setting
4.GNSS

6


Select [4.GNSS] and [Free zone], press the  button.

7

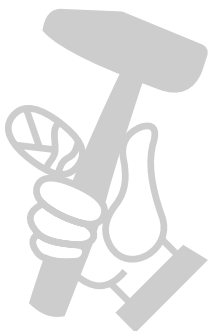
Select [2.Timer] and press the  button.

Free zone
1.Zone setting
2.Timer

8

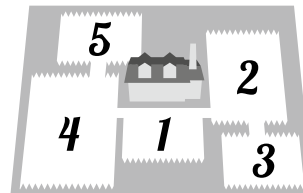
Select [1.Always], [2.1 Month] or [3.1 Week] and press the  button.

After the period set by the timer has passed, the Free zone settings will be cancelled.



Garden layout

*If your lawnmower model type is HRM1000, use Mii-monitor on smartphone/ tablet. Refer to “5 Mii-monitor Preparation” (☞ page 79).



Docking direction

Home screen → Menu screen → [2.Garden setup] → [2.Garden layout] → [1.Docking direction]

Garden setup
1.Mowing setup
2.Garden layout
3.Homing setup

You can set the direction for the lawnmower to move in relation to the docking station.

NOTE:

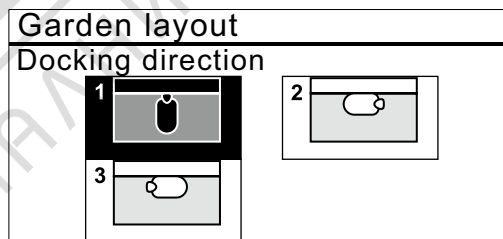
- Before configuring the settings, confirm the completion of installing the docking station and laying boundary wire with your dealer.
- For details on the boundary wire connection of the docking station terminals, see “Installing boundary wire and connecting to the docking station” (☞ page 27).

1

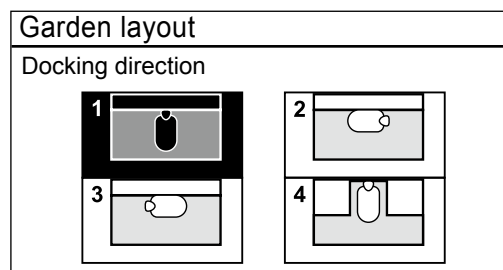
Select the set pattern.

There are 3 or 4 installation methods.

HRM1500, HRM1500 Live

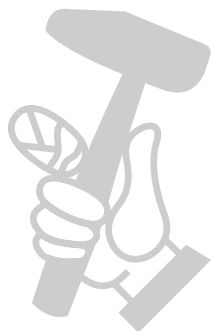


HRM2500, HRM2500 Live



2

Press the button.



● Wire length/Garden size

 Home screen → ^{Menu screen} [2.Garden setup] → [2.Garden layout] → [2.Wire length...]

You can configure the information of your garden layout to operate the lawnmower.

NOTE:

- Before configuring the settings, confirm the completion of installing the docking station and laying boundary wire with your dealer.
- If the DEALER CHECKSHEET at the end of Owner's Manual was already filled out by your dealer, refer to it when configuring the settings.

1 Enter the values of the boundary wire length and garden size.

Garden layout	
Boundary wire length	
<input type="text" value=" _0m"/> (50-800m)	
Garden size	
<input type="text" value=" _ _00m<sup>2</sup>"/> (100-3000m ²)	

2 Press the  button.

3 Press the  button to return to the previous screen.


● Signal type/shortcut wire

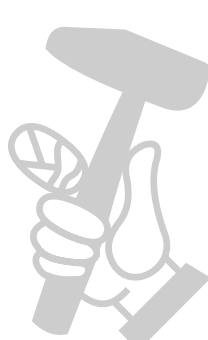
 Home screen → ^{Menu screen} [2.Garden setup] → [2.Garden layout] → [3.Single type/short cut wire]

When changing the signal type, do so while the lawnmower is not docked with the docking station.

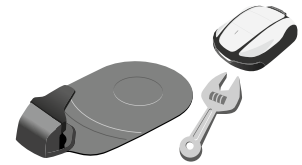
1 Enter the signal type and number of the shortcut wire.

Garden layout	
Signal type	
<input checked="" type="checkbox"/> A <input type="checkbox"/> B <input type="checkbox"/> C <input type="checkbox"/> D	
Shortcut wire quantity	
<input type="checkbox"/> 0 <input checked="" type="checkbox"/> 1	
NEXT	

2 Dock the lawnmower to the docking station. [Finish] is displayed, select [NEXT] and press  button.



■ Homing setup



● Passage width

 Home screen → Menu screen → [2. Garden setup] → [3. Homing setup] → [1. Passage width]

Garden setup
1. Mowing setup
2. Garden layout
3. Homing setup

You can set the minimum and maximum gap between the lawnmower and boundary wire or Shortcut wire when the lawnmower returns to the docking station along the wire.

By setting this gap, you can prevent wheel tracks from forming because the lawnmower returns home on different routes.

Increase the gap as much as possible. The higher the setting value, the less likely it is that wheel tracks will form.

You can input a value from 0 to 12 for the setup level.

Boundary wire passage width sample table

Boundary wire

Setup level	Passage width
0	10 cm
1	25 cm
2	30 cm
3	35 cm
4	40 cm
5	50 cm
6	60 cm
7	70 cm
8	80 cm
9	90 cm
10	100 cm
11	110 cm
12	130 cm

Shortcut wire


Setup level	Passage width
1	25 cm
2	30 cm
3	35 cm
4	40 cm
5	50 cm
6	60 cm
7	70 cm
8	80 cm
9	90 cm
10	100 cm
11	110 cm
12	130 cm

- The field strength varies depending on the length of the wire. The field becomes weaker with a longer wire, and stronger with a shorter wire.
- When the value is high (by avoiding moving along the same path), you can reduce wheel tracks in the grass.
- The numerical values of this table are for reference to return the lawnmower to the docking station along a straight line.
- The numerical values may differ depending on the actual conditions.

TIPS Use as big passage width as possible so to reach the area quickly.

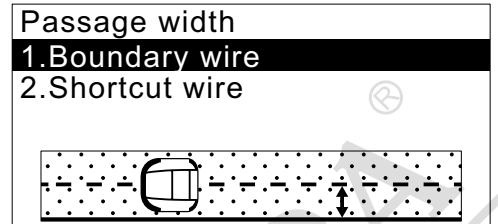
It is recommended to use the shortcut wire to pass through narrow passages (HRM1500, HRM1500 Live, HRM2500, HRM2500 Live).

1

Select [1.Boundary wire] or [2.Shortcut wire] and press the  button.

NOTE:

- [2.Shortcut wire] is not displayed if the shortcut wire is not installed.



2

If [1.Boundary wire] is selected, choose clockwise or anti-clockwise and enter the Min and Max values.
If [2.Shortcut wire] is selected, enter the Min and Max values for [S1].

3

Press the  button.

● **Capacity for homing**

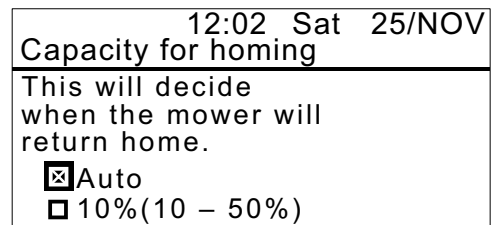
 Home screen → Menu screen → [2.Garden setup] → [3.Homing setup] → [2.Capacity for homing]

You can set the percentage of remaining amount of the battery when the lawnmower starts to go back to the docking station.
The longer the wire is, the higher this value should be.

1

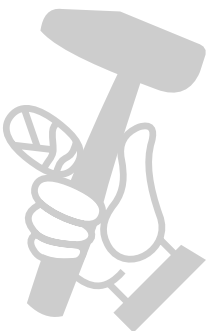
Select [Auto] or Enter a percentage of battery residual capacity.

The range of the percentage of battery residual capacity is 10 – 50%.



2

Press the  button.



● Satellite assisted homing (HRM1500 Live, HRM2500 Live only)


 Home screen → ^{Menu screen} [2. Garden setup] → [3. Homing setup] → [3. Satellite assisted homing]

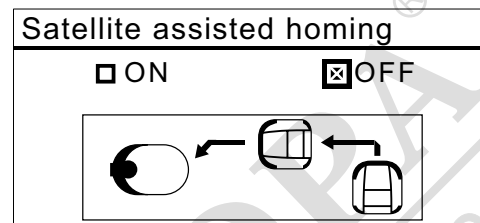
This function remembers the position of the station and the position of the lawnmower based on the GNSS position information, and starts moving toward the docking station from the work end position.

NOTE:

- This function may not work in complex gardens with many narrow passages and obstacles, or when GNSS accuracy is low (behind buildings, trees, etc.). In such a case, we recommend using a shortcut wire.

1

Select [ON] or [OFF], and press the  button.



● Test return home

 Home screen → ^{Menu screen} [2. Garden setup] → [3. Homing setup] → [0. Test return home]

You can test if the lawnmower will correctly return to the docking station.
Test returning through the different passages.

NOTE:

- Perform this test when the lawnmower is not connected to the docking station.

1

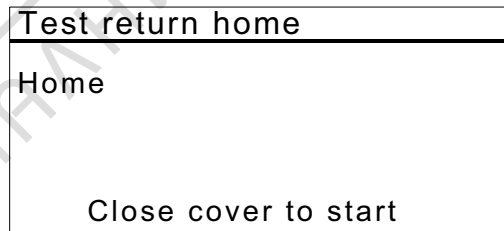
Close the control panel cover.

The lawnmower returns to the docking station.

2

When the lawnmower is docked at the docking station, press the manual STOP button.

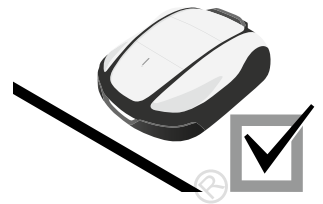
The control panel cover pops up.
The message "Test finished" appears on the display.



■ Checking the system

■ Check signal

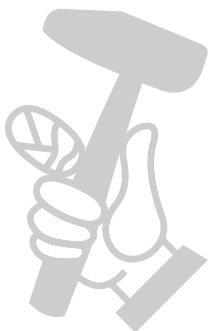
You can check if the boundary wire signal is correctly reaching the lawnmower and confirm how strong the signal is.



 Home screen → ^{Menu screen} [3.Diagnostics] → [1.Check signal]

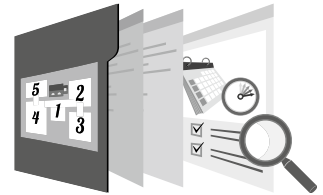
Menu
1.Work timer
2.Garden setup
3.Diagnostics
4.History
5.System settings
6.Setup wizard

Signal level indication	Signal strength
Lv0	No loop signal
Lv1	Weak
↑↓	↑↓
Lv5	Moderate
↑↓	↑↓
Lv10	Strong




■ Test start points

You can check whether the lawnmower can correctly return to the docking station, and whether it can reach each start points according to settings.



● Test start points

 **Home screen** → ^{Menu screen} **[3.Diagnostics]** → **[2.Test start points]** → **[1.Point1] to [3.Point 3] (HRM1000, HRM1500, HRM1500 Live) or [5.Point 5] (HRM2500, HRM2500 Live)**

You can configure 3 start points (HRM1000, HRM1500, HRM1500 Live) or 5 start points (HRM2500, HRM2500 Live).

You can test that the lawnmower reach each start points according to settings.

NOTE:

- Perform this test when the lawnmower is connected to the docking station.

1

Select a point from 1 to 3 or 5 which you want to test and press the  button.

2

Confirm the value of the selected point settings.

3

Close the control panel cover.


The lawnmower starts to the selected start point. When the test is correctly finished, the lawnmower rolls slowly from side to side showing the minimum and maximum exit angle, and a beep sound is emitted from the lawnmower.

4

Press the manual STOP button.

The control panel cover pops up. The message "Do you want to modify the start point?" appears on the display.

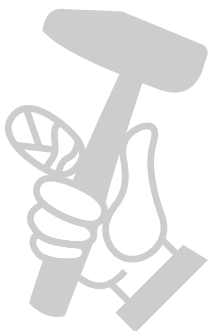
5

Select [Yes] or [No] to the question and press  button.

If you select [Yes], Start point screen appears. You can modify the settings of the tested start point. If you select [No], the previous screen appears.

NOTE:

- For details on the start point settings, see "2. Setting the start points" (📖 page 34).



● Home



Home screen → ^{Menu screen} [3.Diagnostics] → [2.Test start points] → [0.Home]

You can test if the lawnmower will correctly return to the docking station.

NOTE:

- Perform this test when the lawnmower is not connected to the docking station.

1

Close the control panel cover.

The lawnmower returns to the docking station.

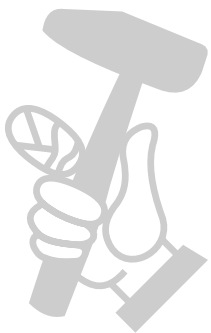
2

When the lawnmower is docked at the docking station, press the manual STOP button.

The control panel cover pops up. The message “Test finished” appears on the display.

NOTE:

- For details on the homing settings, see “Homing setup” (▣ page 65).

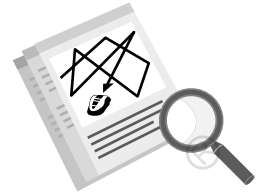


МАГАЗИН МАЙСТОРА
БАШ ПРОФЕСИОНАЛНИ РЕШЕНИЯ

Viewing history

Operation history

You can check the cumulative time that the lawnmower has operated and recharged.



Home screen → ^{Menu screen} [4.History] → [1.Operating history] → [1.Operating time]

Menu
1.Work timer
2.Garden setup
3.Diagnostics
4.History
5.System settings
6.Setup wizard

You can view how long the lawnmower has mowed, and how long the lawnmower has charged.

1

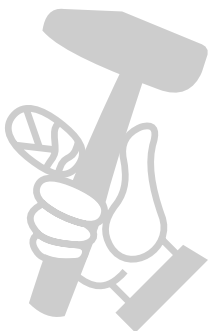
Select [1.Operating time] and press the button.

The history is displayed.

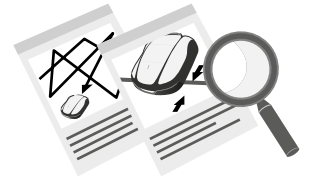
2

Press the button to return to the previous screen.

		12:02 Sat 25/NOV
		Operating time
This is the total cutting time. →	Cutting	180h55min
This is the total charging time. →	Charging	140h37min



Work history



Home screen → **[4.History]** → **[1.Operating history]** → **[2.Work history]**

Menu screen

You can view the lawnmower's cutting history (when the lawnmower was mowing), return history (when the lawnmower was returning to the docking station), and charge history (when the lawnmower was charging).

NOTE:

- Only the history of the Auto mode is displayed.

- 1 Check the history by pressing the ▲▼ down buttons to scroll the menu.
- 2 Press the ⏪ button to return to the previous screen.

Each time indicates how long the lawnmower was mowing (time when the blades were rotating). The most recent entry is [01], and the oldest entry is [10].

12:02 Sat 25/NOV

Work history

Cutting history

01: 22 min	1	06: 43 min	3
02: 60 min	2	07: 67 min	4
03: 53 min	3	08: 33 min	5
04: 12 min	1	09: 59 min	1
05: 62 min	2	10: 45 min	2

The start point number where the lawnmower was mowing is displayed.

This mark indicates that there is another page. Use the ▲▼ buttons to change pages.

This displays the time taken to return to the docking station after mowing is finished. A new entry is added to the history list every time the lawnmower returns.

12:02 Sat 25/NOV

Work history

Return history

01: 5 min	06: 7 min
02: 8 min	07: 10 min
03: 10 min	08: 5 min
04: 5 min	09: 8 min
05: 8 min	10: 10 min

The time for the most recent charge history entry is displayed first.

12:02 Sat 25/NOV

Work history

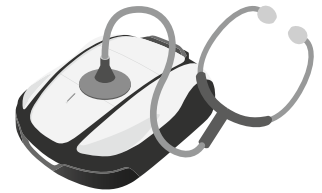
Charge history


01: 32 min	06: 43 min
02: 66 min	07: 77 min
03: 53 min	08: 33 min
04: 42 min	09: 59 min
05: 71 min	10: 45 min



Fault history

You can view the lawnmower's fault history (when a fault occurred).



 **Home screen** → Menu screen → **[4.History]** → **[2.Fault history]**

The history of errors that have occurred are logged.

NOTE:

- If the same error occurs repeatedly many times on the same day, only the time when the first error occurred is saved.

1

Select fault history entry by using the ▲ ▼ buttons.

2

Press the ⏪ button. Fault information is displayed. For details on faults, see "7 TROUBLESHOOTING" (page 97).

3

Press the ⏩ button to return to the previous screen.

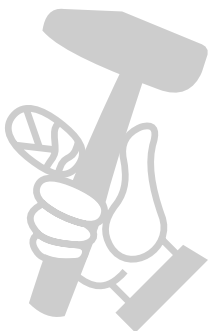
The most recent fault error entry is displayed first. Press the ⏪ button for more information.

	15:03	Fri	26/JAN
Fault history			
1.	3A136	25.01.24	13:31
2.	3A124	25.01.24	13:23
3.	3A111	25.01.24	13:23
4.	3A114	25.01.24	13:17
5.	-		
6.	-		

Fault information and the time of the fault are displayed.

	15:03	Fri	26/JAN
Fault history			
01:No boundary signal			
Warning			
25.01.24 13:31			

This mark indicates that there is another page. Use the ▲ ▼ buttons to change pages.



Setting the system

Language

You can set the menus of the display to your preferred language.



 **Home screen** → Menu screen **[5.System settings]** → **[1.Language]**

Menu
1.Work timer
2.Garden setup
3.Diagnostics
4.History
5.System settings
6.Setup wizard

Select the language shown in the display from among 12 languages.

NOTE:

- If you want to set other languages, contact your dealer.

1
2

Select your preferred language.

Press the  button to return to the previous screen.

Display/Sound



Contrast

 **Home screen** → Menu screen **[5.System settings]** → **[2.Display/Sound]** → **[Contrast]**

You can set the contrast of the control panel display.

1
2

Change the contrast level by pressing the   buttons.

Press the  button to return to the previous screen.

● BG color

 Home screen → ^{Menu screen} [5. System settings] → [2. Display/Sound] → [BG color]

You can set the background color of the control panel display.

1

Select [White] or [Black] by pressing the ▲▼ buttons.

2

Press the ⏪ button to return to the previous screen.

● Keypad

 Home screen → ^{Menu screen} [5. System settings] → [2. Display/Sound] → [Keypad]

You can set whether or not a beep sound is emitted when you press control panel buttons.

1

Select [ON] or [OFF] by pressing the ▲▼ buttons.

2

Press the ⏪ button to return to the previous screen.

■ Date and Time

You can set the internal date and time for the lawnmower.



 Home screen → ^{Menu screen} [5. System settings] → [3. Date and Time]

Set the date and time for the lawnmower. The timer operates based on this date and time setting.

1

Enter the date with the format {Day}/ {Month}/{Year} and the time in 24-hour format using the number buttons.

2

Press the ⏪ button.

3

Press the ⏩ button to return to the previous screen.



■ Security

Security settings are used to prevent the lawnmower from being operated by other people.

Security settings require you to enter your PIN. If you forget your PIN, enter the PIN written in “DEALER CHECKSHEET” (see page 128) in this manual. If the lock is not released, please contact your dealer.



● Alarm

 **Home screen** → ^{Menu screen} **[5.System settings]** → **[4.Security]** → **[1.Alarm]**

NOTE:

- Before selecting [1.Alarm], you will need to input your PIN. If you forget your PIN, contact your dealer.

This setting enables or disables the alarm. When set to [OFF], all alarms other than the alarm before the blades start moving are disabled.

NOTE:

- The [OFF] setting also disables the security alarm that is triggered when the incorrect PIN (Personal Identification Number) is entered 3 times in a row.

1 Select [ON] or [OFF] by pressing the   buttons.

2 Press the  button to return to the previous screen.

● Create a PIN

 **Home screen** → ^{Menu screen} **[5.System settings]** → **[4.Security]** → **[2.Create a PIN]**

NOTE:

- Before selecting [2.Create a PIN], you will need to input your PIN. If you forget your PIN, contact your dealer.

You can modify the PIN used for unlocking the control panel menus. Make sure to create the PIN to prevent theft of the lawnmower, unauthorized access, etc.

1 Input a new PIN using the number buttons.

2 Press the  button. The message “Activated” is displayed.


3 Press the  button to return to the previous screen.

NOTE:

- Write down your PIN in the space provided. See “DEALER CHECKSHEET” (see page 128). If you forget your PIN, contact your dealer.



● Accessory option

 Home screen → ^{Menu screen} [5.System settings] → [4.Security] → [3.Accessory option]

NOTE:

- Before selecting [3.Accessory option], you will need to input your PIN. If you forget your PIN, contact your dealer.
- Consult your dealer about accessory option.

1 Select [ON] or [OFF] by pressing the ▲ ▼ buttons.

2 Press the ⏪ button to return to the previous screen.

● TCU (HRM1500 Live, HRM2500 Live only)

NOTE:

- TCU is an abbreviation for Telematics Control Unit, which is a communication device using a mobile network.
- IMEI is an abbreviation for International Mobile Equipment Identifier.

 Home screen → ^{Menu screen} [5.System settings] → [4.Security] → [4.TCU]

NOTE:

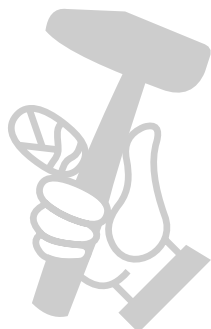
- Before selecting [2.Create a PIN], you will need to input your PIN. If you forget your PIN, contact your dealer.

You can check the IMEI of the TCU and reboot it.

1 Press the up or down button to select [1.IMEI] and press ⏪ button. IMEI value is displayed.

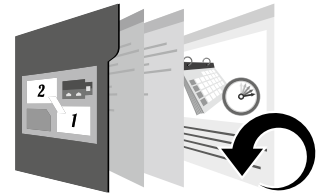
2 When restarting the TCU, press the up or down button to select [2.Restart] and press ⏪. The message "Restart TCU?" is displayed.

3 Press ⏪ button to return to the previous screen.




Reset

You can reset all settings to the factory defaults.





Factory reset

 **Home screen** → ^{Menu screen} **[5.System settings]** → **[5.Reset]** → **[1.Factory reset]**

Execute this command to revert all settings to their factory defaults.

NOTE:

- This command will not reset the history of the lawnmower (working and fault history). This only resets the settings of the lawnmower.
- Consult your dealer before executing this command.
- Dealer settings will be lost after this command.

- 1 Input your PIN and press the  button.
- 2 Select [Yes].
- 3 Press the  button. After the message "Activated" is displayed, the power turns off.


Restore dealer settings

 **Home screen** → ^{Menu screen} **[5.System settings]** → **[5.Reset]** → **[2.Restore dealer settings]**

Reset to the settings configured by the dealer.

NOTE:

- This command will not reset the history of the lawnmower (working and fault history). This only resets the settings of the lawnmower.
- Consult your dealer before executing this command.

- 1 Select [Yes].
- 2 Press the  button. After the message "Finished" is displayed.

Help

You can get the information of the lawnmower such as the model name, frame serial number, and software version.



 ^{Menu screen} **Press and hold number button "0"**

This is the software version. →

Help	
Honda Power Equipment	
Miimo	:HRM2500 Live
	:MCNF-1000001
Software version	
Main ECU	:0.1.1
Display ECU	:0.1.1

← This is the model name.
← This is the frame serial number.

NOTE:

- If the Frame number is "0000000", contact your dealer.

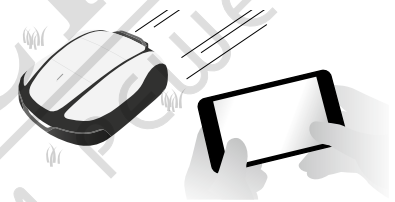
5 Mii-monitor Preparation

About Mii-monitor

Mii-monitor is a smartphone/tablet application. It communicates with HRM1500 Live and HRM2500 Live via mobile networks and with HRM1000, HRM1500, HRM1500 Live, HRM2500 and HRM2500 Live by Bluetooth®. For operation, use a smartphone that can access the internet.

NOTE:

- The images in this manual are for visual reference only. They may differ from the actual screen.
- The features, screens, design, etc. in this manual may be subject to change without notice.
- The operation methods (screens, procedures) in this manual are examples. They may differ depending on your smartphone model.



Mii-monitor features

- Check the status of the lawnmower
 - Settings identical to the lawnmower control panel
 - Various settings such as operation time
 - Voice operation through AI speaker (Alexa)*
 - Backup and reset your settings on the Honda server
 - Error notification to user*
 - Theft notification with location acquisition and geofencing (dealer setting)*
 - Send trouble reports to your dealer if there is an error
- * Only available for "Live" model

Learn more about Mii-monitor

For more information about how to operate Mii-monitor and supported smartphone/tablet models, please refer to the Mii-monitor Operation Guide (online manual).

To find it, please visit

https://cf.hondapps.com/files/OP/OP000396GLOBAL/Miimonitor_User_Guide_2_EU.pdf



Installing Mii-monitor

Scan the QR code to download Mii-monitor.
Data charges may apply when downloading the application.

App Store®



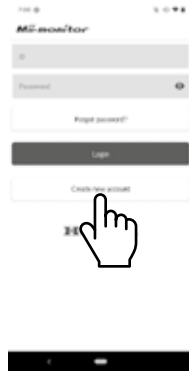
Google Play™



Registering a user

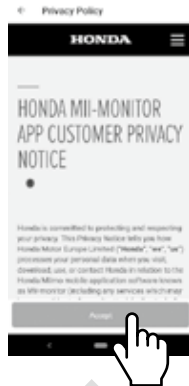
1

Tap [Create new account].



2

Confirm the content. If you accept, tap [Accept].



3

Register a Serial Number (see page 10).

QR code

Manual input



4

Check that the input is correct and Input [Email Address].



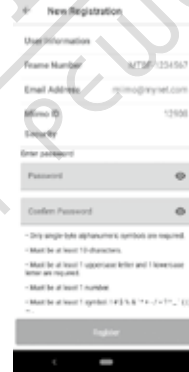
5

Input [User Information] and tap [Next]. Fields with the * mark are required.



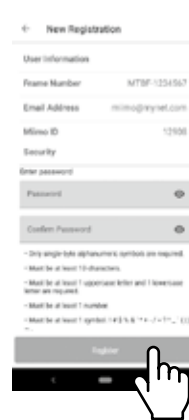
6

Input a password.



7

Tap [Registration] to send the inputted information to the Honda server.



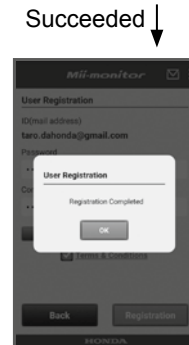
Try again after a while. Also, check if you can connect to the network.



OR



Contact the dealer where you purchased the lawnmower.



Pairing a device (connecting via *Bluetooth*[®])

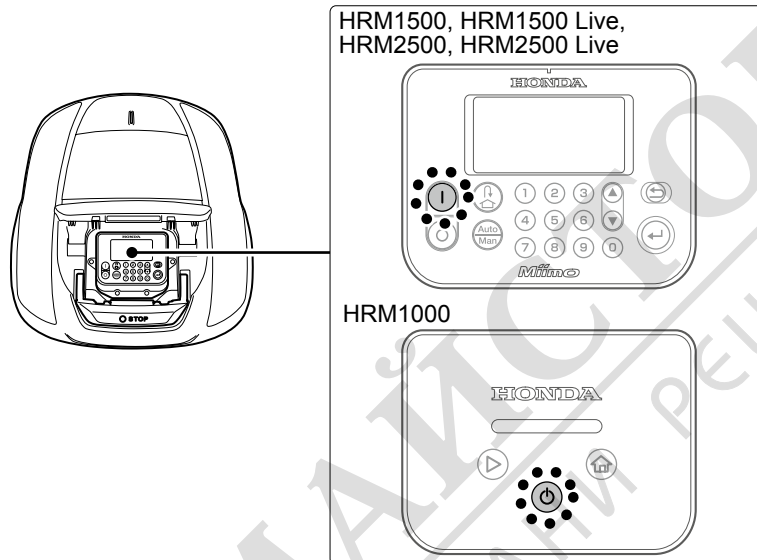
- It is not possible to connect more than one user id to the same lawnmower. If you want to connect more than one smartphone/tablet to your lawnmower, the same user id must be used on all devices.
- To operate the lawnmower with Mii-monitor, you must pair it with a smartphone/tablet.
- To pair the lawnmower, Initial Settings (except HRM1000) on the lawnmower must be completed.
- *Bluetooth*[®] is a short-range communication technology. It is operable within a distance of about 3 m.

1

HRM1500, HRM1500 Live, HRM2500, HRM2500 Live
Press the **(On)** button on the control panel.

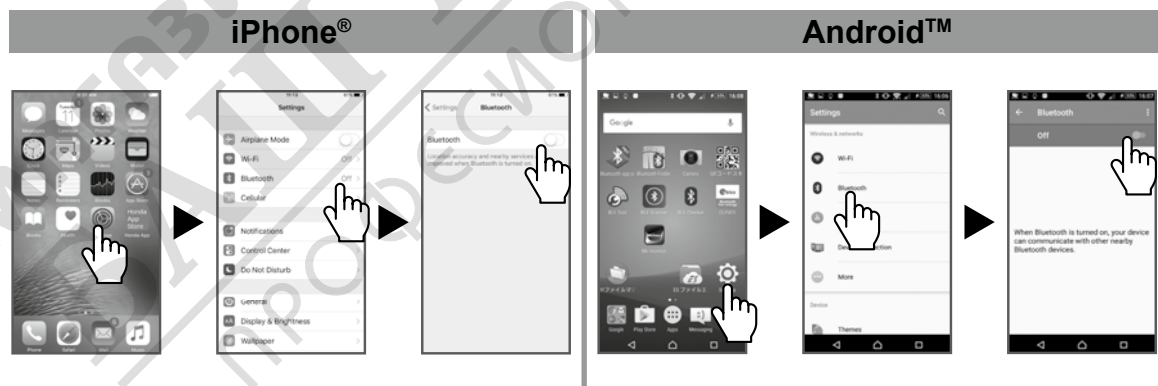
HRM1000

Press the **(Power On/Off)** button on the control panel.



2

Turn on *Bluetooth*[®] in the smartphone.

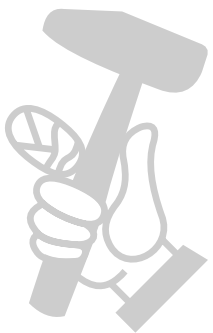


3

After a while, the search results are displayed.
Tap the serial number of the lawnmower you want to connect (see page 10).



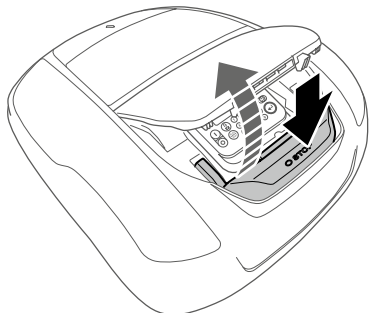
If the serial number of the lawnmower is not displayed, the *Bluetooth*® of the lawnmower or smartphone may have frozen.
Turn off the lawnmower, turn off *Bluetooth*® in the smartphone, restart, and then try again.



МАГАЗИН
БАШ МАЙСТОРА
ПРОФЕСИОНАЛНИ РЕШЕНИЯ

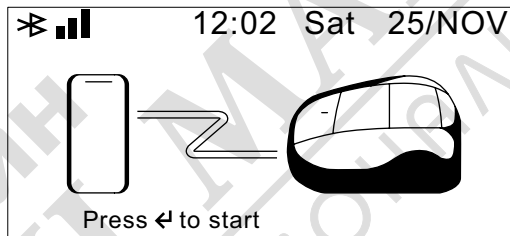
Menu display after connecting to a device

If your smartphone and the lawnmower are connected when you press STOP button, the following screen is displayed.

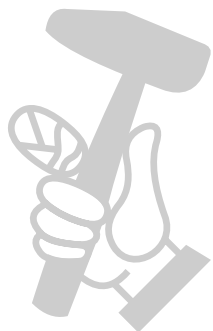


Displayed when connected to a paired device.

Example: Bluetooth® connected state



Displayed during remote control.



6 USAGE

Checking the mowing area

Before operating the lawnmower, ensure the mowing area is free of animals and foreign objects.

Turn off the lawnmower before removing any foreign objects.

NOTE:

- If there are any holes (such as rabbit holes, etc.) in the work area, fill them in so that the work area is level. Periodically check the work area for holes.



Also confirm that the height of the grass is 65 mm or less.

NOTE:

- Adjust the height of the blades to mow the grass within 5 mm. If the grass is taller than 65 mm, cut the grass using a standard lawnmower. For details on how to adjust the height of the blades, see "Adjusting the height of the blades" (page 93).



Connecting to a power source

Follow the steps below when connecting to a power source.

Follow these steps in reverse when disconnecting from a power source.

For details on moving the AC adapter or changing to a different power outlet, contact your dealer.

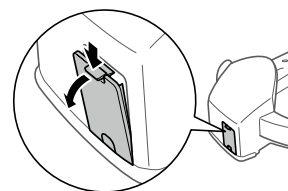
NOTE:

- Connect the station only to a supply circuit protected by a residual current device (RCD) with a tripping current of not more than 30 mA.

HRM1000, HRM1500, HRM1500 Live

1 Remove the connector cover from the station.

1

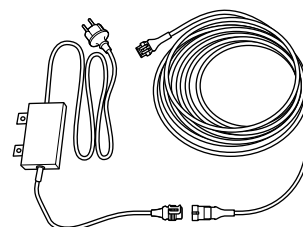


2

If the power cord of the AC adapter is not long enough, connect the extension cord.

NOTE:

- When disconnecting the connectors, make sure to lift the clip.
- When the length of the cord is not enough even if you use an extension cord, extend the power outlet (House) side.

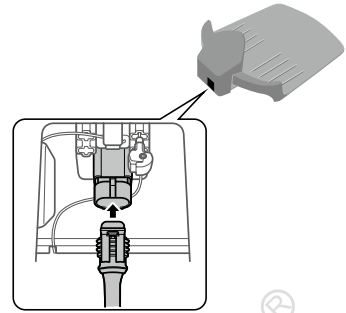


3

Connect the power cord connector to the station's internal connector.

NOTE:

- When disconnecting the connectors, make sure to lift the clip.



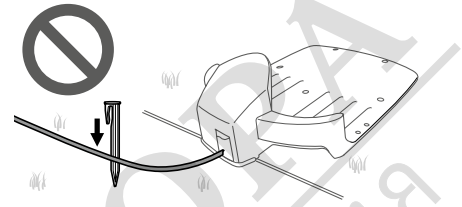
4

Attach the connector cover to the station.

(The power cord and boundary wire should go through the notch in the connector cover.)

CAUTION

Do not secure the power cord with the pegs used to secure the boundary wire. Doing so may damage the power cord.



5

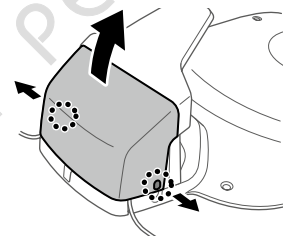
Connect the AC adapter plug to a power outlet with the designated voltage.

Power outlet voltage for the E, EC, S, and SC types: AC 230 V
Power outlet voltage for the B and BC type: AC 240 V

HRM2500, HRM2500 Live

1

Remove the station cover from the docking station.



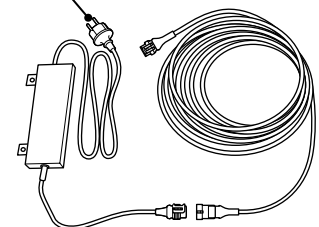
2

If the power cord of the AC adapter is not long enough, connect the extension cord.

NOTE:

- When disconnecting the connectors, make sure to lift the clip.
- When the length of the cord is not enough even if you use an extension cord, extend the power outlet (House) side.

Power outlet (House) side



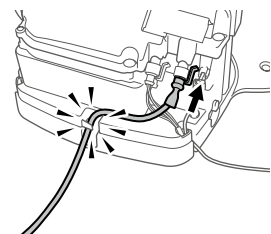
3

Connect the power cord connector to the station's internal connector.

Pass the power cord through the tabs as shown.

NOTE:

- When disconnecting the connectors, make sure to lift the clip.

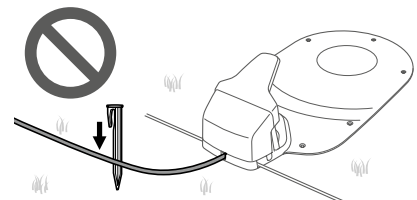


4

Attach the station cover to the docking station.

CAUTION

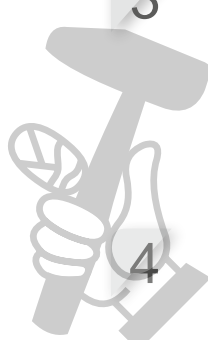
Do not secure the power cord with the pegs used to secure the boundary wire. Doing so may damage the power cord.



5

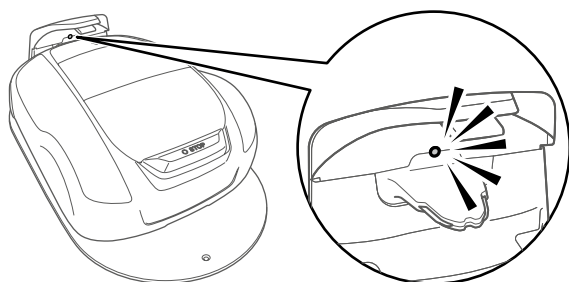
Connect the AC adapter plug to a power outlet with the designated voltage.

Power outlet voltage for E, EC, S and SC types: AC 230 V
Power outlet voltage for B and BC type: AC 240 V



Checking the lawnmower

Before operation, check to make sure that it is connected all the way into the docking station.

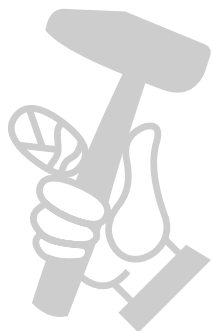


The light above the charging plug changes as follows:

LED	Description
Green	The docking station signal setting is correct.
Green (blinking)	The boundary wire is too long. The shortcut wire becoming disconnected.
Amber	The lawnmower is correctly connected to the docking station.
Amber (blinking)	The boundary wire becoming disconnected.
Red	Confirm the connection of the connectors (see page 110). If the connection is normal, the docking station may be malfunctioning. Contact your dealer.
Red (blinking)	A station signal problem—such as the station wire becoming disconnected or cut—has occurred. Contact your dealer.
Off	Confirm the connection with the power cord. If the docking station is correctly connected with the power cord, a power failure has occurred. Contact your dealer.

NOTE:

- Do not touch the recharging connector. If you touch it, you may become injured.
- If the lawnmower is not correctly connected to the docking station, the battery cannot recharge.



Turning on / off the power

Turning on the power

After the battery is charged, press the **ⓘ** (On) button (HRM1500, HRM1500 Live, HRM2500, HRM2500 Live) or **Ⓞ** (Power On/Off) button (HRM1000) to turn on the lawnmower.

The **ⓘ** / **Ⓞ** button is located on the control panel.

⚠ WARNING

- Do not insert your finger beneath the closed operation panel cover or height adjustment dial cover.
- When stopping the lawnmower, approach it from the back. Approaching it from the front or sides may lead to unintended contact with the lawnmower, and you may fall over it when the lawnmower begins to move.

1

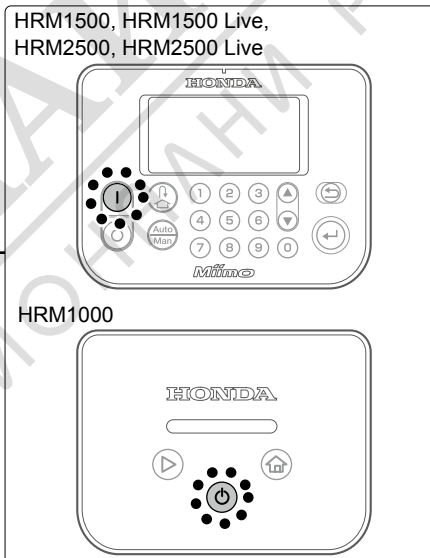
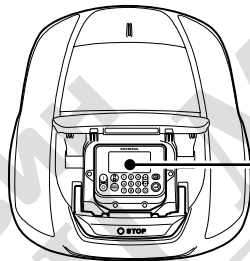
Press the manual STOP button.
The control panel cover pops up.

2

HRM1500, HRM1500 Live, HRM2500, HRM2500 Live
Press the ⓘ (On) button on the control panel.
The power turns on, and the startup screen on the control panel is displayed.

HRM1000

Press the Ⓞ (Power On/Off) button on the control panel.
The power turns on, and the indicator is blinking white.



Entering your PIN (Personal Identification Number)

When turning the lawnmower on, you must enter the PIN.
For HRM1000, enter the PIN on the Mii-monitor screen.

NOTE:

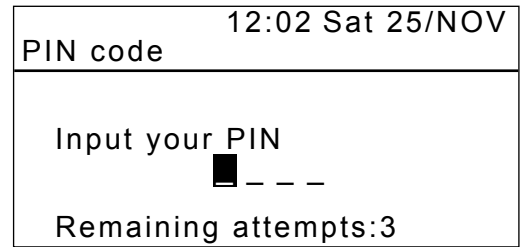
- If you input an incorrect PIN 3 times in a row, the control panel is locked for 5 minutes, during which time you cannot perform operations.
- If you forget the PIN, consult your dealer.
- If an error message is displayed, see "7 TROUBLESHOOTING" (page 97).

1


Enter the PIN using the number buttons.

NOTE:

- To change the PIN, see "Create a PIN" (page 76).



2

Press the  button.
The home screen is displayed.




● **Turning off the power**

1

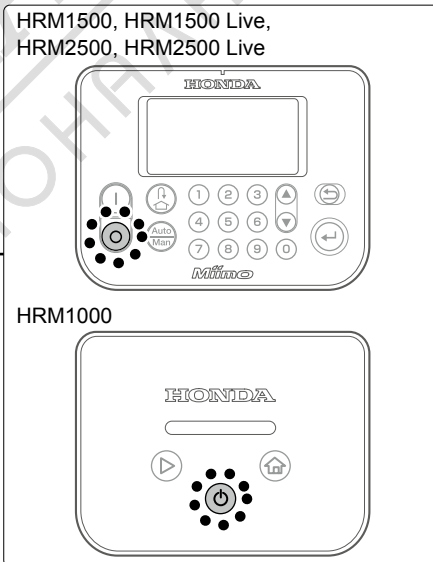
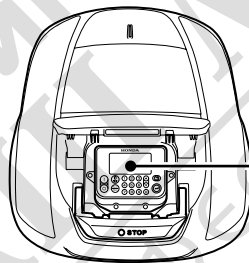
Press the manual STOP button.
The control panel cover pops up.

2

HRM1500, HRM1500 Live, HRM2500, HRM2500 Live
Press the  (Off) button on the control panel.

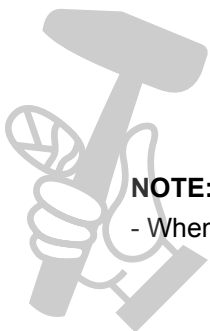
HRM1000

Press and hold the  (Power On/Off) button on the control panel for 3 seconds.



NOTE:

- When you turn off the lawnmower, it will not begin to operate even if you set the timer.



Operating the lawnmower in the Auto mode

*If your lawnmower model type is HRM1000, use Mii-monitor on smartphone/tablet. Refer to “5 Mii-monitor Preparation” (☞ page 79).

These instructions can be used to operate the lawnmower at the time scheduled for the Auto mode settings.

NOTE:


- For details on settings, see “4 MENU SETTINGS” (☞ page 44).

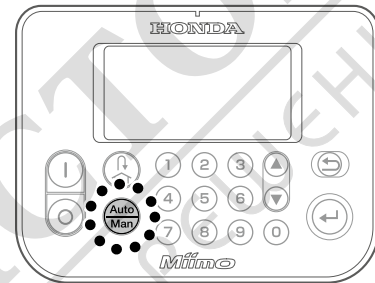
▲ WARNING

- Make sure to press the manual STOP button before performing the following procedure.

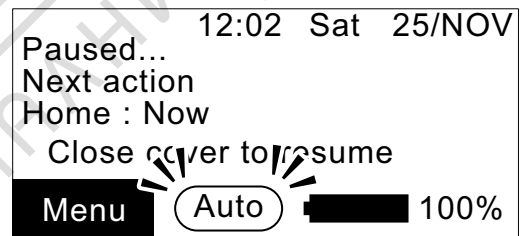
1 Press the  button.

2 If the [Auto] is displayed on the Home screen, go to step 3.

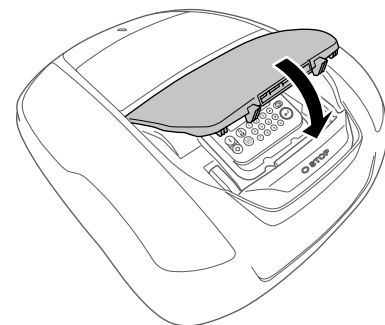
If the [Man] is displayed on the Home screen, press the  (Auto / Manual) button until the [Auto] is displayed.



For details on the icons in the screen, see “Home screen” (☞ page 13).




3 Close the control panel cover.



Setting is now complete. The lawnmower starts mowing at the time scheduled for the Auto mode. For details on settings, see “4 MENU SETTINGS” (☞ page 44).

NOTE:

- If you press the  (Off) button after configuring these settings, the lawnmower will not activate.

Operating the lawnmower in the Manual mode


*If your lawnmower model type is HRM1000, use Mii-monitor on smartphone/tablet. Refer to “5 Mii-monitor Preparation” (☞ page 79).

Use the Manual mode when you want to ignore work timer settings.

As an example, you can move the lawnmower by yourself if there are two or more separated mowing areas within the boundary wire, the mower cannot travel between the areas.

Set the following necessary settings such as [Mowing pattern] to operate in the Manual mode.

● Selecting the mowing pattern

 **Home screen** → Menu screen **[2.Garden setup]** → **[1.Mowing setup]** → **[2.Mowing pattern]** → **[2.Manual mode]** → Select the mowing pattern from **[Random]**, **[Directional]** or **[Mixed]**.

For details, see “Mowing pattern”(☞ page 56).

● Wire overlap

 **Home screen** → Menu screen **[2.Garden setup]** → **[1.Mowing setup]** → **[3.Advanced setting]** → **[1.Wire overlap]**.

For details, see “Wire overlap”(☞ page 57).

● Edge cutting

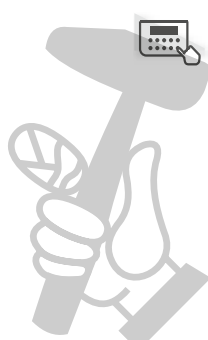
 **Home screen** → Menu screen **[2.Garden setup]** → **[1.Mowing setup]** → **[3.Advanced setting]** → **[2.Edge cutting]**

For details, see “Edge cutting”(☞ page 58).

● Spiral cutting



 **Home screen** → Menu screen **[2.Garden setup]** → **[1.Mowing setup]** → **[3.Advanced setting]** → **[3.Spiral cutting]**

For details, see “Spiral cutting”(☞ page 60).



Example of the Manual mode operation

These instructions can be used to operate the lawnmower for the Manual mode settings.

1 **HRM1000**
Press and hold the  (Power On/Off) button on the control panel for 3 seconds
HRM1500, HRM1500 Live, HRM2500, HRM2500 Live
Press the  (Off) button on the control panel.
The power turns off.

2 Close the control panel cover.

3 Carry the lawnmower to the desired area.
For details on carrying the lawnmower, see “8 MAINTENANCE” (page 102).
Instead of carrying the lawnmower, you can drive it with Mii-monitor application Remote Controller.

4 Press the manual STOP button.
The control panel cover pops up.

5 Press the  (Power On/Off) or  (On) button on the control panel.
The power turns on, and the startup screen on the control panel is displayed.


6 **HRM1000**
For the following steps, operate using the smartphone/tablet Mii-monitor. Refer to “5 Mii-monitor Preparation” (page 79).
HRM1500, HRM1500 Live, HRM2500, HRM2500 Live
Enter the PIN using the number buttons to display the Home screen.

7 Press the  (Auto / Manual) button repeatedly until Manual mode screen is displayed.

12:02 Sat 25/NOV
Manual mode
<input checked="" type="checkbox"/> Mow until empty <input type="checkbox"/> Mow then recharge continuously <input type="checkbox"/> Mow then resume auto timer

8 Select an operation of lawnmower.

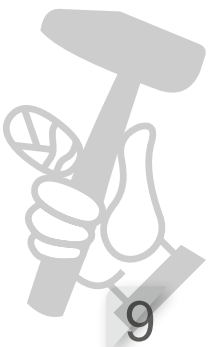
Items	Description
Mow until empty	The lawnmower works until battery is empty.
Mow then recharge continuously	The lawnmower works and charges until the work mode is changed to the Auto mode by the user.
Mow then resume auto timer	You can specify how many times the lawnmower works and charges (1 – 10 times). After the specified number of times, the lawnmower switches to the Auto mode and resumes the timer.

9 Press the  button.

10 Close the control panel cover.
The lawnmower automatically begins to operate.

NOTE:

- The lawnmower does not turn off automatically when in manual mode.




■ Canceling the Manual mode operation


You can cancel the operation which you selected on the Manual mode screen and the lawnmower returns to the docking station.

NOTE:

- If you select [Mow then resume auto timer], the lawnmower will stop at the time of the work timer configured in the Auto mode.

1 Press the manual STOP button from behind the lawnmower.

2 **HRM1000**
Press and hold the  (Power On/Off) button on the control panel for 3 seconds

HRM1500, HRM1500 Live, HRM2500, HRM2500 Live
Press the  (Off) button on the control panel.
The power turns off.

3 Place the lawnmower in a area that is near the docking station.

4 Press the  (Power On/Off) or  (On) button on the control panel.
The power turns on, and the startup screen on the control panel is displayed.

5 **HRM1000**
For the following steps, operate using the smartphone/tablet Mii-monitor. Refer to “5 Mii-monitor Preparation” (▣ page 79).


HRM1500, HRM1500 Live, HRM2500, HRM2500 Live
Enter the PIN using the number buttons to display the Home screen.

6 Press the  (Home) button.

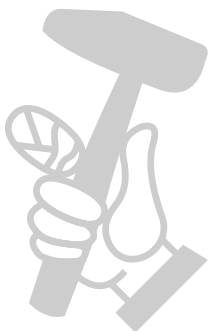
7 Select the operation of lawnmower after going back to the docking station.

12:02 Sat 25/NOV
Go back Home
Then after charging:
<input checked="" type="checkbox"/> Restart on next timer
<input type="checkbox"/> Pause mowing at home for specified time.
<input type="checkbox"/> Stay at home

Items	Description
Restart on next timer	The lawnmower goes back home, then switches automatically to the Auto mode and resumes the timer.
Pause mowing at home for specified time.	You can set the standby time of the lawnmower to 1 – 24 hours. After the standby time has passed, the lawnmower switches to the Auto mode.
Stay at home	The lawnmower stays at the docking station after charging.

8 Press the  button.
Home screen is displayed.

9 Close the control panel cover.
The lawnmower returns to the docking station.



Adjusting the height of the blades

The height of the blades determines how tall or short the grass will be cut. Test the lawnmower on a small area and adjust blade height according to your preference.

⚠ WARNING

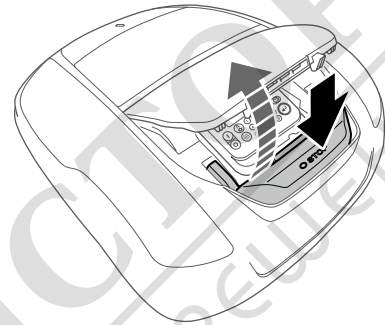
- Make sure to press the manual STOP button before performing the following procedure.

CAUTION:

- Avoid cutting too much at once. Mow gradually step by step (from level 5 to 1.)
- Avoid cutting more than 5 mm of grass at once. If you want to cut more than 5 mm, it should be done gradually in steps of 5 mm maximum per week. Example: decreasing from 50 to 30 mm should require 4 weeks with 5 mm steps.

1

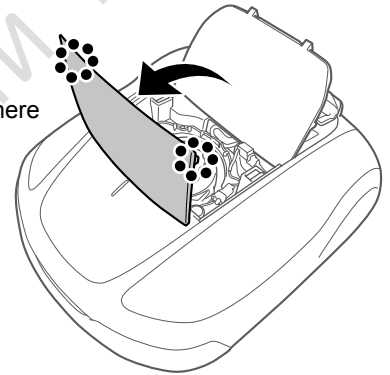
Press the manual STOP button. The control panel cover pops up.



2

Open the height adjustment dial cover with your finger.

Insert your finger here and pull up.

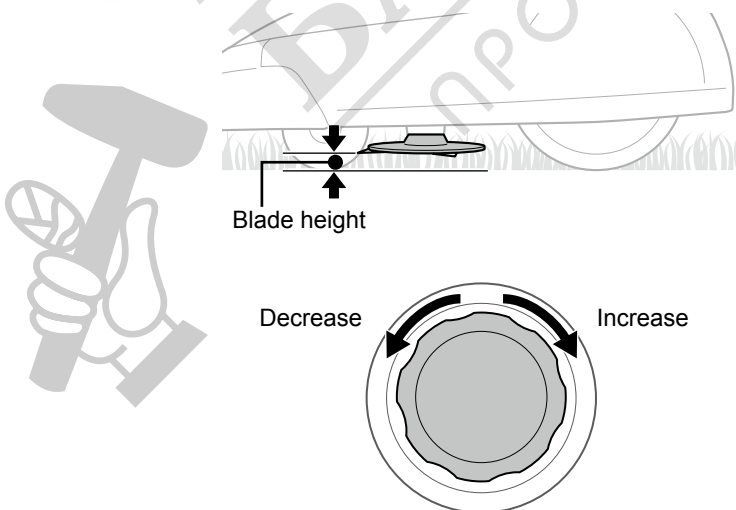


3

Turn the dial anti-clockwise to lower the blades, or turn the dial clockwise to raise the blades. Use the numbers on the dial to approximate the height of the blades.

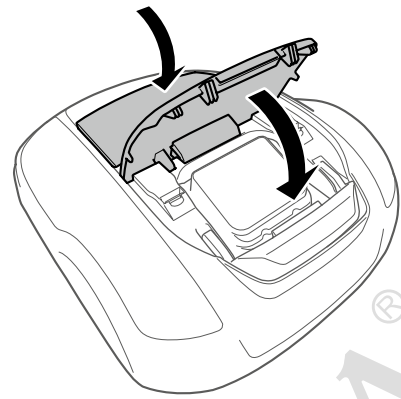
Approximate blade heights for each dial position:

Position	Approximate blade height
1	20 mm
2	30 mm
3	40 mm
4	50 mm
5	60 mm



4

Close the height adjustment dial cover, and close the control panel cover.



Repeat the steps above if you need to make additional adjustments.

Weekly checks

Check the lawnmower and docking station once a week to remove dirt and grass. Also check if the blades and blade disc have been damaged, and verify that there are no other problems.

● Cleaning the lawnmower and docking station

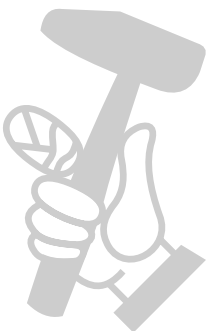
Dirt and grass may accumulate on the top and bottom of the lawnmower, docking station, and charging plug during and after mowing.

For details on how to clean the lawnmower, see "8 MAINTENANCE" (page 102).

● Checking the blades and blade disc for problems

The blades and blade disc may become damaged while mowing. Make sure to perform weekly checks of the blades and blade disc.

For details on how to check the blades and blade disc, see "8 MAINTENANCE" (page 102).



Carrying the lawnmower

When carrying the lawnmower, observe the following points.

⚠ WARNING

- Do not carry the lawnmower with the blades pointed toward you.
- Take care to avoid dropping the lawnmower when carrying it.

HRM1000

- Make sure to press the manual STOP button and press and hold the Ⓞ (Power On/Off) button for 3 seconds to turn the power off before performing the following procedure.

HRM1500, HRM1500 Live, HRM2500, HRM2500 Live

- Make sure to press the manual STOP button and press the Ⓞ (Off) button to turn the power off before performing the following procedures.
- Make sure the lawnmower (especially the blades) does not touch anyone when you are carrying it.

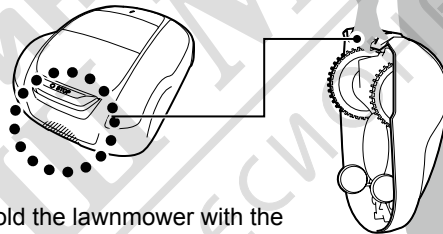
HRM1000

1. Press the manual STOP button to open the control panel cover, and press and hold the Ⓞ (Power On/Off) button for 3 seconds.

HRM1500, HRM1500 Live, HRM2500, HRM2500 Live

1. Press the manual STOP button to open the control panel cover, and press the Ⓞ (Off) button.
2. Close the control panel cover.
3. Pick up the lawnmower by the carrying area.

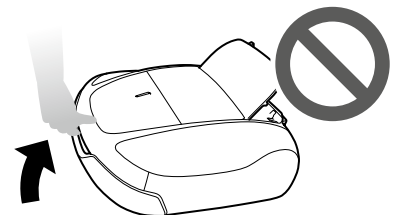
Lift the lawnmower with one hand from the rear side with the blades pointed away from you.



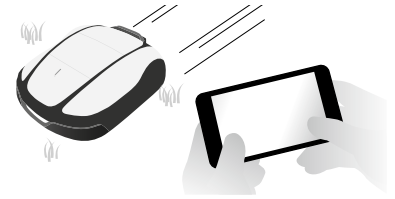
Always hold the lawnmower with the blades facing away from you.

⚠ CAUTION

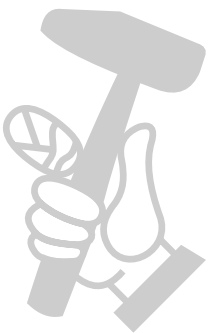
- When carrying the lawnmower, make sure to carry it by carrying area at the lower rear of the lawnmower. If carrying it by any other area, you may be injured by the blades or charging socket area of the lawnmower, or the lawnmower may fall and become damaged.
- Do not lift or carry the lawnmower by holding it from the opening in the front.
- Do not carry the lawnmower while it is attached to the docking station. The lawnmower and docking station may be damaged.



- You can use the remote control feature of Mii-monitor to move the lawnmower. When using remote control, follow the precautions below.
 - Operate in a brightly-lit area
 - Avoid operating on wet grass
 - Thoroughly watch your footing on inclines
 - Do not forcefully connect the lawnmower to the docking station using remote control.
The docking station may get damaged.



МАГАЗИН
БАШ МАЙСТОРА[®]
ПРОФЕСИОНАЛНИ РЕШЕНИЯ



7 TROUBLESHOOTING

Before contacting your dealer

In the unlikely event that you are facing a problem and you need to contact your dealer, ensure that you have the following information available.

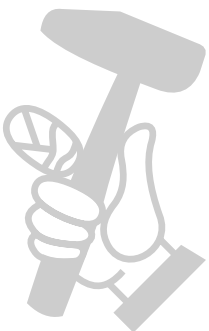
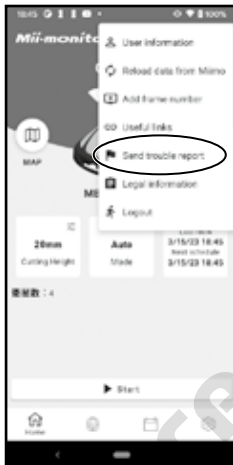
- Owner's Manual
- Consider any recent work in your garden.
- [Fault history] information

 **Home screen** → **Menu screen** → **[4.History]** → **[2.Fault history]**

Mii-monitor has an option to send trouble reports to your dealer.

If the problem is not resolved even after referring to the following troubleshooting guide, send a trouble report to your dealer.

 **Top screen** → **☰ (in the upper-right)** → **[Send trouble report]**



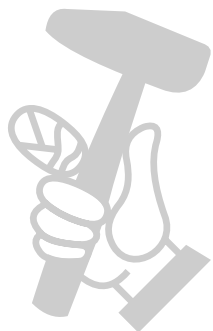
Messages

If any of the following messages appear in the display, use this troubleshooting guide to address the problem before contacting your dealer. If the problem persists, contact your dealer.

Message	Cause	Solution
*Lock out display	The PIN code is incorrect.	Please enter the correct PIN code. If you forget your PIN, contact your dealer.
Area signal lost	The lawnmower does not detect the boundary wire signal.	Check if the boundary wire connectors are correctly connected. If the message does not disappear, contact your dealer.
Battery capacity low	The battery does not charge enough.	Increase the remaining capacity of homing. See "Homing setup" (▣ page 65). If the message does not disappear, contact your dealer.
Battery capacity reduced	The battery does not charge enough.	
Battery temp high	The battery temperature is too high.	Set the power to ON, and wait until the message disappears. If the message does not disappear, contact your dealer.
Battery temp low (1) Battery temp low (2)	The battery temperature is too low.	Put the lawnmower in a place where the temperature 5°C or higher, set the power to ON, and wait until the message disappears. If the message does not disappear, contact your dealer.
Battery voltage high (1)	The battery charges too much.	Remove the lawnmower from the docking station, set the power to ON, and wait until the message disappears. If the message does not disappear, contact your dealer.
Battery voltage low	The battery does not charge enough.	Charge the lawnmower with the docking station. This message disappears if the battery is charged more than 10%. If the message does not disappear, contact your dealer.
Blade motor temp high	The temperature of the blade motor is or exceeds 85°C.	Leave the power ON and the control panel cover open, and wait 15 to 30 minutes until the message disappears. If the message does not disappear, contact your dealer.
Clock reset	The backup battery power has drained during long-term storage. The clock has been reset.	Set the current date and time. The time must be in 24-hour format. If the clock cannot be set, contact your dealer.
ENT key	The Ⓜ (Enter) button was pressed while the lawnmower was running (with the control panel cover closed).	Open the control panel cover and check if any foreign objects are stuck inside. If this message appears after removing any foreign objects, contact your dealer.
Excessive tilt	The lawnmower is in an excessively tilted area.	Place the lawnmower on a flat surface, and enter the PIN so that the message disappears. If the message does not disappear, contact your dealer.
Key pad	A button was pressed while the lawnmower was running (with the control panel cover closed).	Open the control panel cover and check if any foreign objects are stuck inside. If this message appears after removing any foreign objects, contact your dealer.
Mower lifted	The cover has been lifted by something, e.g. a stone.	Enter the PIN so that the message disappears. If the cover is heavily damaged or the message does not disappear, contact your dealer.
No boundary signal	The lawnmower does not detect the boundary wire signal.	Check if the boundary wire connectors are correctly connected. Check a power supply of docking station. See "Test start points" (▣ page 69). If the message does not disappear, contact your dealer.

Message	Cause	Solution
Obstruction detection	An obstruction is being detected, or the sensor detects something.	Enter the PIN so that the message disappears. If the message does not disappear, contact your dealer.
Outside loop	The lawnmower exited the boundary wire.	Move the lawnmower into the work area. Check the power supply of the docking station. Check if the boundary wire connectors are correctly connected. If the message does not disappear, check if the boundary wire connectors are correctly connected, and check if there are no similar lawnmowers in the area or any electronic device or electrical installation that could interfere with the lawnmower signal. If the message still does not disappear, contact your dealer.
Tire slip	The lawnmower has detected tire slip.	Measure the depth of the groove in the center of the rear wheel (tire). If it is 3 mm or less, contact your dealer or authorized service agent for replacement.
Upside down	The lawnmower is upside down.	Place the lawnmower on a flat surface, and enter the PIN so that the message disappears. If the message does not disappear, contact your dealer.
Contact your dealer if the following messages have appeared.		
*Auto power off Battery Error Battery temperature Blade motor Blade motor blocked Bluetooth communication Charging control Clock	Communication Error Data memory Error Display Unit Error IMU sensor Lift sensor Manual stop Motor ECU Error Motor relay	Motor sensor Blade Motor sensor L Motor sensor R Rollover sensor Stop SW Tilt sensor Wheel motor Wheel motor blocked

It may be necessary to exchange the battery. Contact your dealer with the operating history ready (cutting time, charging time, returning time).

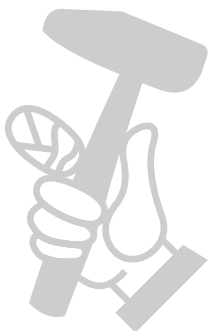


Resolving problems

Unless having the power on is necessary to check something, turn off the power when checking the condition of the lawnmower or the blade.

Problem	Solution
The lawnmower cannot be charged.	Check the cord connections, confirm that the docking station's LED indicator is on (LED indicator should turn on), check that there are no foreign material in the charging socket that prevent a good electrical connection, and charge the lawnmower again. If the lawnmower still cannot be charged, contact your dealer.
The lawnmower does not dock into the docking station.	<ul style="list-style-type: none"> - Check station condition if it deformed or not. Check the boundary wire underneath the station (see page 16). Clean up the charging socket of both the lawnmower and station. - Check the front (caster) wheels are not damaged. If the front (caster) wheels are damaged, the lawnmower height will change and it may not be possible to dock with the docking station.
The control panel cover cannot be opened when the manual STOP button was presses.	Press again near center of manual STOP button. The control panel cover cannot opened in case of pressing one side of manual STOP button.
The lawnmower is found stopped, and switched off in the garden.	<ul style="list-style-type: none"> - A power failure occurred. The lawnmower behaves as follows: In case that the power supply is cut off for more than 30 minutes, the lawnmower will shut off automatically to prevent the battery from becoming empty. In case that the power supply comes back within 30 minutes, the lawnmower will start mowing automatically. * * The lawnmower will return to the docking station if the battery residual capacity is low.
The lawnmower goes out of the boundary wire.	Record where the lawnmower goes out of wire. Check the ground condition, weather condition and tyre condition when the lawnmower goes out of the boundary wire. Clean up the tyre if it has any mud, leaves, or grass. Try to continue. If the issue occurs frequently, contact your dealer.
A strange noise is heard from the lawnmower or the lawnmower vibrates.	Check the blades if they are broken or not. Broken blades can create an unbalanced blade disc. It can create noise. Try to use "Quiet timer". Contact your dealer if it cannot be solved.
The lawnmower will not enter an area, or the blades and movement have stopped.	The lawnmower will try to evade an area with a slope of more than 20°. In the case of a 25 – 30deg slope (depending on unevenness of the ground) <ul style="list-style-type: none"> - The lawnmower will try to escape from the slope In the case of a slope more than 30deg slope - The lawnmower will try to evade an area a few seconds and stop due to "Excessive tilt"
The lawnmower leaves the preset area or behaves differently from the settings.	See the error message on the screen and follow the instructions before contacting your dealer. If you cannot solve the issue, contact your dealer with the error messages ready.
Poor mowing results.	<ul style="list-style-type: none"> - The cutting height is incorrect or the grass is too high. Adjust the cutting height or cut with a standard lawnmower first if the grass is too high. - Check the condition of the blades (see page 113).
The lawnmower does not leave the docking station. No error message is displayed.	<ul style="list-style-type: none"> - Timers were not set up correctly. Check the timer settings. See "4 MENU SETTINGS" (see page 44). - The Date and Time are incorrect. Check the clock (see page 75). - The manual STOP button was pressed, but the ⏻ button was not pressed before closing the control panel cover. - The lawnmower is in inactive mode. Another cause could be that the machine is in "Home" mode. - The lawnmower in the Auto mode will always charge the battery up to 100%. If you want to make the lawnmower to start mowing sooner, change the operating mode to the Manual mode.
The lawnmower does not enter narrow corridors.	Check the "passage width" setting. If necessary, reduce the value of the passage width. Use the shortcut wire (HRM1500, HRM1500 Live, HRM2500, HRM2500 Live).

Problem	Solution
Noticeable wheel tracks.	Try to reduce the work timer. You can reduce the work timer automatically by using “Seasonal timer”. Try to increase “passage width”.
The lawnmower stops frequently.	Operation of this product with other wireless devices, remote controls, or electric fences is not guaranteed. Contact your dealer.
The lawnmower does not work inside the boundary wire.	- If there are electromagnetic and electric fields near the boundary wire such as power line, factory, electric noise might affect the movement of your lawnmower. Contact your dealer.
The smartphone cannot connect (pair) with the lawnmower.	- Check if the lawnmower is on. When turning it on, wait 5 seconds before connecting. - The smartphone may be too far from the lawnmower. Bring it closer to the lawnmower. - Connecting (pairing) will not succeed if someone is already connected to the lawnmower via Bluetooth®. Do not communicate via Bluetooth® at the same time.
The boundary wire has slackened and come out of the ground or a peg has come out of the ground.	Stop the lawnmower because it may cut the wire. Be careful not to trip on the boundary wire or peg. Contact your dealer.



МАГАЗИН
БАШ МАЙСТОР
ПРОФЕСИОНАЛНИ РЕШЕНИЯ

8 MAINTENANCE

Periodic inspection and maintenance

The lawnmower must be periodically inspected and maintained for safety and to keep it running at a high level of performance.

Periodic maintenance will also help to extend service life.

The required service intervals and the kind of maintenance to be performed are described in the following chart. Honda recommends annual service to be completed by your local authorised Honda dealer. The dealer will be able to perform a variety of checks and software updates that cannot be completed by the owner.

Maintenance schedule

REGULAR SERVICE PERIOD		Every week	Every year or every 840h operating hours. (Cutting time)	Page
Perform at every indicated period or operating hour interval, whichever comes soonest.				
Blade & Blade nut ⁽¹⁾	Check	○		(☞ page 113)
Blade disc ⁽¹⁾	Check	○		(☞ page 113)
Drain hole	Check or clean	○	○ ⁽²⁾	(☞ page 104)
Manual stop button	Check		○	(☞ page 105)
Body parts ⁽¹⁾	Clean	○		(☞ page 104)
	Check		○ ⁽²⁾	–
Charge socket	Check or clean	○		(☞ page 112)
	Replace		If necessary ⁽²⁾	–
Work motor	Check or clean		○ ⁽²⁾	–
Traction motor	Check or clean		○ ⁽²⁾	–
Traction motor (wheel axles)	Check (grease) or clean		○ ⁽²⁾	–
Wheels	Check or clean	○		(☞ page 111)
	Replace		If necessary ⁽²⁾	–
Front caster & ball bearing & bushing	Check or clean	○		(☞ page 111)
	Replace		If necessary ⁽²⁾	–
Covers	Clean	○		–
	Check		○ ⁽²⁾	–
Frame inside	Clean		○ ⁽²⁾	–
Frame seals	Replace		○ ⁽²⁾	–
Cover Mount Structure	Clean		○ ^{(2), (6)}	–
	Check		○ ⁽²⁾	–
Obstruction sensor (Mount Cap / Mount Shaft)	Replace		If necessary ^{(2), (5)}	–
Battery condition	Check		○ ^{(2), (4)}	–
Docking station	Clean	○		(☞ page 105)
	Check		○	(☞ page 106)
Docking station Screws	Check or tightness	○ ⁽³⁾		(☞ page 110)
Docking station (Connectors)	Check		○	(☞ page 110)
Docking station (charging plug)	Check or clean	○		(☞ page 106)
	Replace		If necessary ⁽²⁾	–

(1) Blades, the blade nuts, the blade disc, body parts, the front (caster) wheels, and the rear (drive) wheels should be replaced as needed.

(2) These items should be serviced by your servicing dealer. Please contact your service dealer.

(3) If the screws become loose, tighten them securely.

(4) Confirm using 10 last charges history.

(5) Measure this item, please replace if necessary.

(6) Use a soft brush and cloth. After cleaning, make sure check the boots which are not damaged.

Maintenance procedures

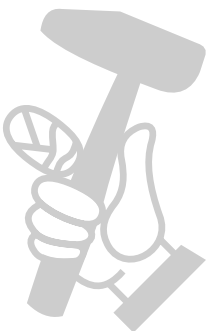
Dirt and grass may accumulate on the top and bottom of the lawnmower during and after mowing, and the blades may become worn, damaged, or unable to turn. Make sure to check the lawnmower according to the chart in "Periodic inspection and maintenance" (☞ page 102).

▲ WARNING

- Make sure to press the manual STOP button and turn the lawnmower off before performing the following procedures.
- Put on a pair of work gloves before performing the following procedures.
- Be careful when performing the following procedures, because blades are extremely sharp.®

NOTE:

- Remove the lawnmower from the docking station when performing the following procedures.

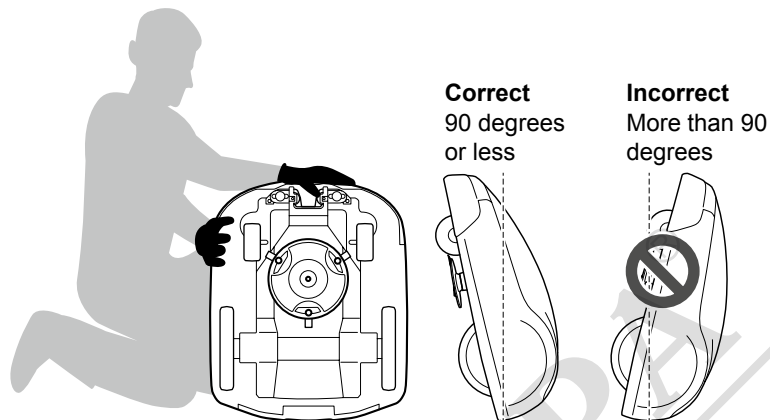


МАГАЗИН
БАШ МАЙСТОРА®
ПРОФЕСИОНАЛНИ РЕШЕНИЯ

■ Preparing

Perform the following procedures in an area not subject to rainfall.

- Put on a pair of work gloves.
- When checking the blades, turn the lawnmower on its side.
- Do not tilt the lawnmower over an angle of 90 degrees to prevent grass clippings or fluid from entering inside the lawnmower.



■ Cleaning

▲ WARNING

- Do not touch the blades with your hands.
- Do not lift the lawnmower off of the ground while checking or cleaning it.
- Make sure to press the manual STOP button and turn the lawnmower off before performing the following procedures.

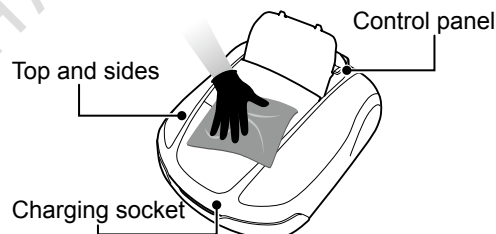
NOTE:

- Do not wash the lawnmower with water. The lawnmower may be damaged.



● Cleaning the body (Exterior)

Clean dirt and grass off of the lawnmower using a brush and cloth.

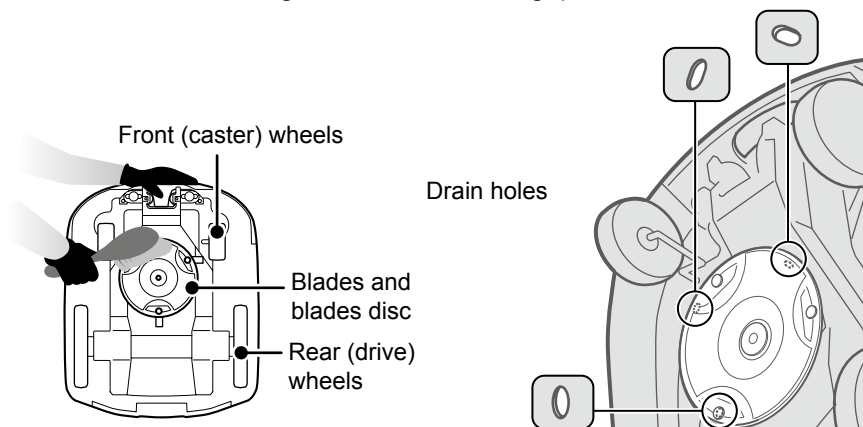


● Removing the grass clippings

By using a dried brush or scraper, remove the grass clippings attached to the blades, driving part and water drain holes.

NOTE:

- Never pour water on the bottom of the lawnmower, and avoid using a sponge or rag soaked with water for cleaning the lawnmower. The lawnmower may be damaged if water or dirt such as grass clippings enter inside of the lawnmower through the drain holes or gaps.



● Cleaning the docking station

▲ WARNING

- Unplug the AC adapter's plug from the power outlet (House) before cleaning it.

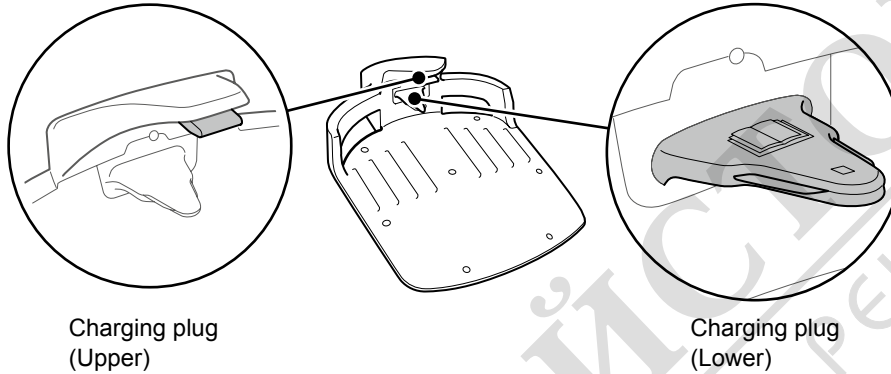
NOTE:

- Do not wash the docking station with water. The docking station may be damaged.

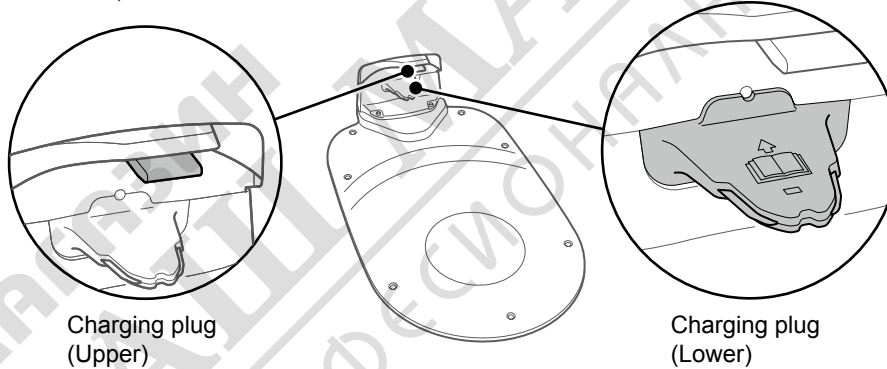
Clean dirt and grass off of the docking station using a plastic brush.

Brush off dirt and grass from docking station, particularly around parts on which the lawnmower rests and around the charging plugs area:

HRM1000, HRM1500, HRM1500 Live



HRM2500, HRM2500 Live



■ Checking

● Checking the manual STOP button

▲ WARNING

- Do not touch the blades with your hands.
- Do not lift the lawnmower off of the ground while checking or cleaning it.

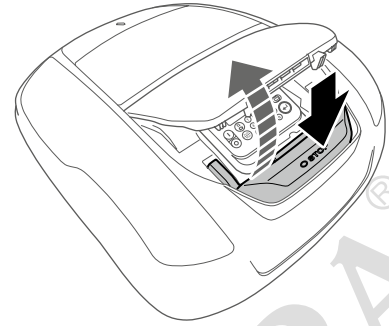
Check item(s)		Action
Manual STOP button and control panel cover	Normal operation of the manual STOP button (and the control panel cover)	While performing a test operation of the lawnmower, press the manual STOP button. If the lawnmower does not stop (and the control panel cover does not open), consult your dealer.

1

Press the **(On)** button on the control panel.

2

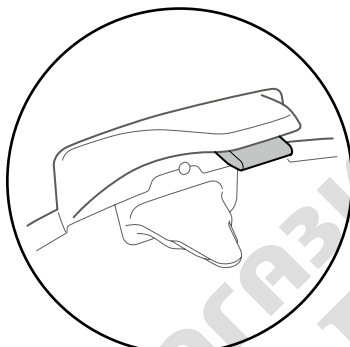
Test a start point (see page 69).
When the lawnmower is moving, press the manual **STOP** button and check that the lawnmower stops.



● Checking the docking station

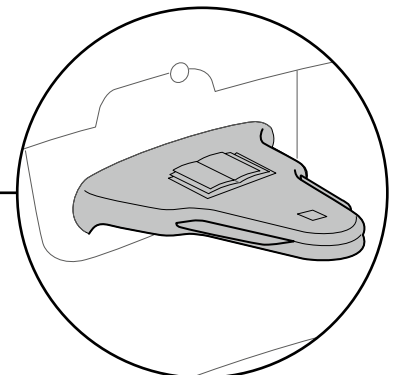
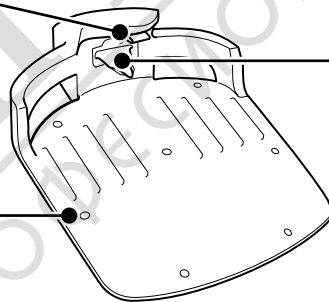
HRM1000, HRM1500, HRM1500 Live

Check item(s)		Action
Docking station	Damage to the docking station	Visually inspect the docking station. If it is damaged, consult your dealer.
Connectors	Loosened connectors of the docking station	Visually inspect the connectors. If they are loose, consult your dealer.



Charging plug (Upper)

Screw



Charging plug (Lower)

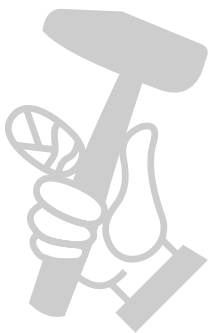
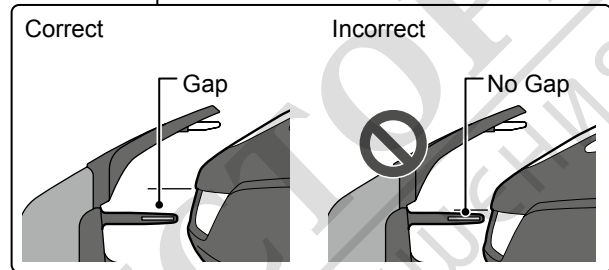
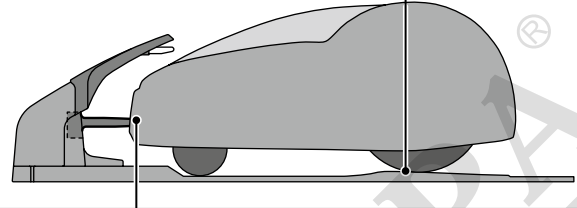
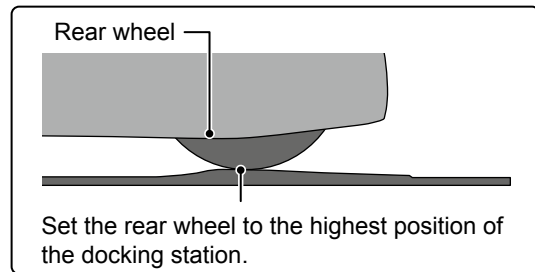
Check item(s)		Action
Docking station	Gap between the docking station's charging plug and the lawnmower's charging socket	Check if there is a gap between the docking station's charging plug and the lawnmower's charging socket. If there is not, adjust the docking station.

1

Locate both rear wheels of the lawnmower at the highest position of the docking station.

2

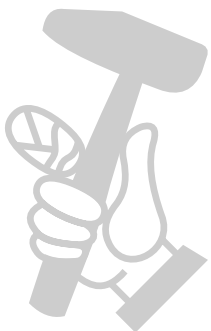
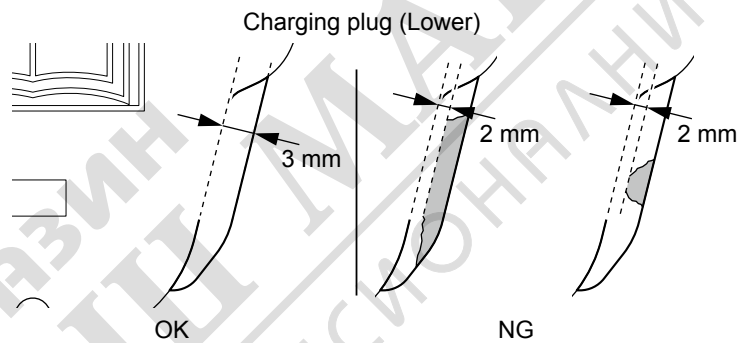
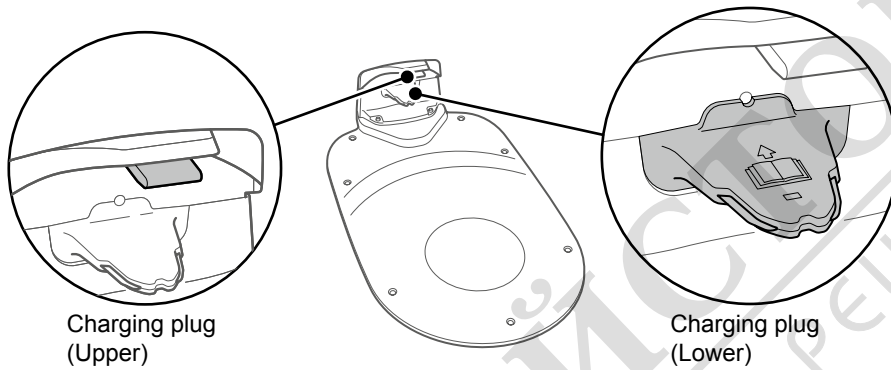
Check if there is a gap between the docking station's charging plug and the lawnmower's charging socket. If there is not, adjust the docking station.



МАГАЗИН
БАШ МАЙ
ПРОФЕСИОНАЛНИ РЕПАРИРА

HRM2500, HRM2500 Live

Check item(s)		Action
Docking station	Damage to the docking station	Visually inspect the docking station. If it is damaged, consult your dealer.
Charging plug	Condition of the charging plug	Visually inspect the metal contacts on the charging plug for corrosion, which can be identified by a greenish discoloration on the contacts. Carefully brush the contacts to remove the corrosion and recheck operation. If the lawnmower still does not charge, contact a servicing dealer.



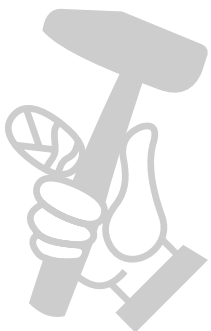
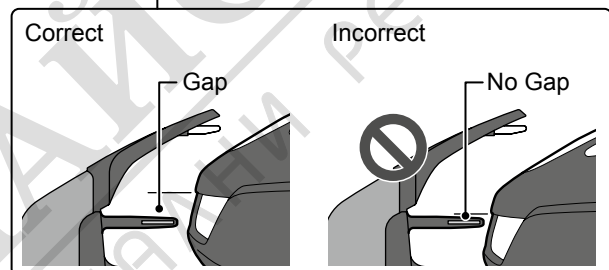
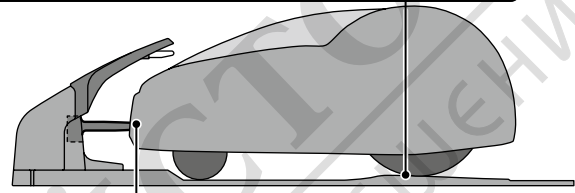
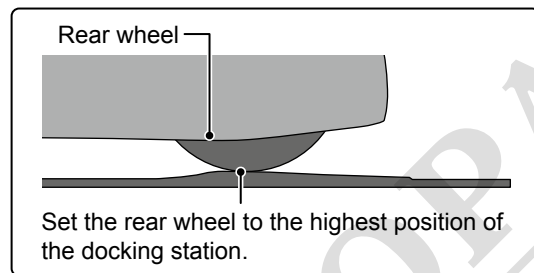
Check item(s)		Action
Docking station	Gap between the docking station's charging plug and the lawnmower's charging socket	Check if there is a gap between the docking station's charging plug and the lawnmower's charging socket. If there is none, adjust the docking station according to the installation conditions (see page 16), or consult your dealer.

1

Locate both rear wheels of the lawnmower at the highest position of the docking station.

2

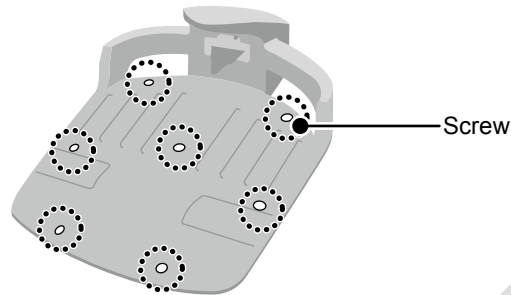
Check if there is a gap between the docking station's charging plug and the lawnmower's charging socket. If there is none, adjust the docking station according to the installation conditions (see page 16), or consult your dealer.



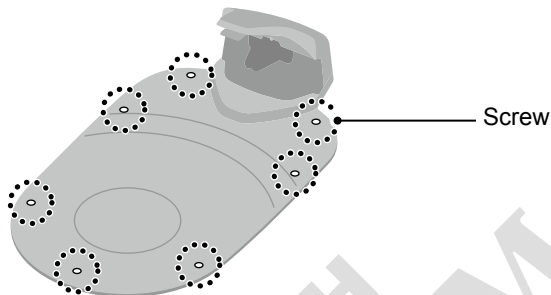
● Checking the docking station screws

Check item(s)		Action
Docking station	Loosened screws of the docking station	Visually inspect the screws. If they are loose, tighten them with a flat-blade screwdriver.

HRM1000, HRM1500, HRM1500 Live



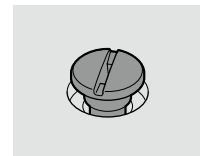
HRM2500, HRM2500 Live



Correct



Incorrect

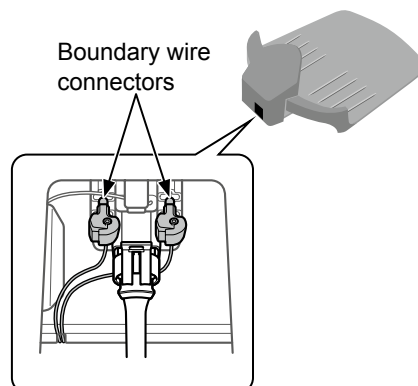


● Checking the boundary wire connectors and 4 pins connector*

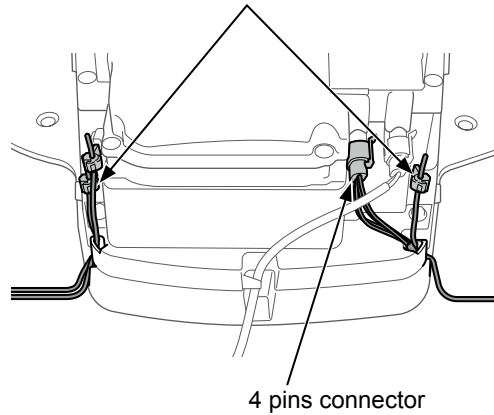
*4 pins connector is for HRM2500 and HRM2500 Live only.

Check item(s)		Action
Boundary wire connectors and 4 pins connector	Looseness of the boundary wire connectors and 4 pins connector	Visually inspect the boundary wire connectors and 4 pins connector. If they are loose, insert them all the way in. If the LED indicator is red, unplug the AC adapter's plug from the power outlet (House), replug it, and then confirm that the LED indicator is back to green.

HRM1000, HRM1500, HRM1500 Live

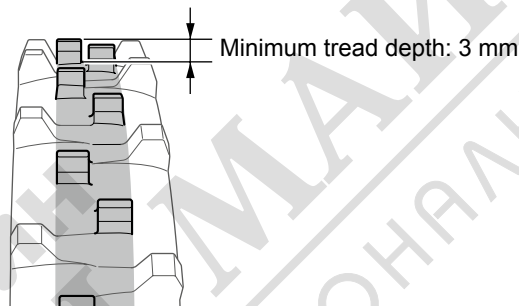


HRM2500, HRM2500 Live
Boundary wire connectors



● Checking the rear (drive) tire tread depth

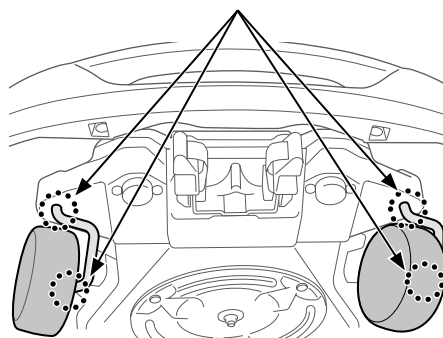
Check item(s)		Action
Rear (drive) tire	Tread depth of the rear (drive) tire	Measure the depth of the treads at the center of the tire. If they are 3 mm or less, contact a service dealer.



● Checking the front (caster) wheel and bearings

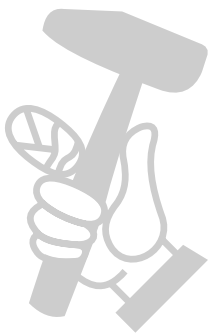
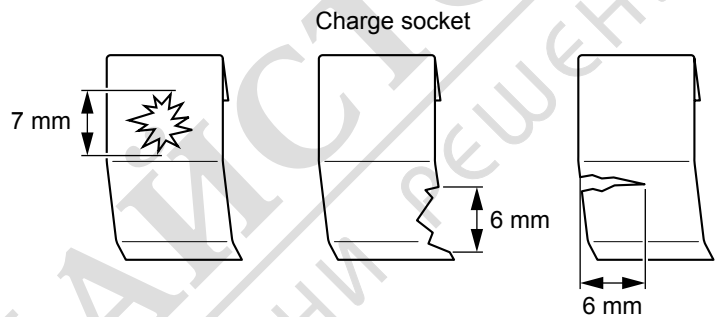
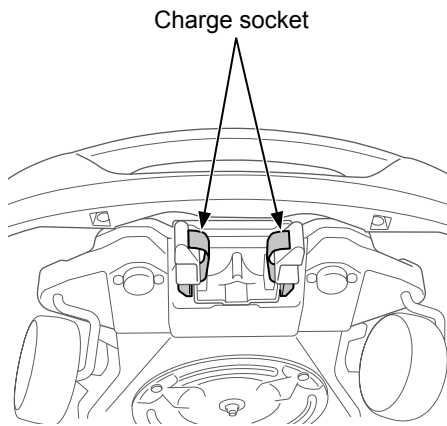
Check item(s)		Action
front (caster) wheel	Front (caster) wheel damage	Visually inspect the front (caster) wheel. If it is damaged, contact a service dealer.
wheel bearings	Bearing movement	Move the front (caster) wheel with your hands and check if it moves smoothly. If it does not move smoothly, contact a service dealer.

Bearings



● Checking the charge socket

Check item(s)		Action
Charge socket	Charge socket clogged with grass clippings.	Visually inspect the metal parts of the charge socket. If the charge socket is clogged with grass, remove the grass clippings.
	Condition of the charge socket	Visually inspect the metal contacts of the charge socket for wear, corrosion, or damage. If there are wear holes larger than 7 mm in diameter or there are cracks longer than 6 mm, contact a servicing dealer for repairs.



● Checking the blades and blade disc

Check the condition of the blades and blade disc as follows.

Lifetime of the blades

In order to have good cutting performance, maintain the sharp cutting edge on the blades. Typically, the lifetime of the blades is 160 hours. (2 weeks to 2 months) Because the lifetime depends on grass condition, it may be necessary to exchange earlier than usual, especially in the spring season.

If your lawn will become the condition of white fiber it is a sign to change blades.

Example: if the lawnmower works for 11.4 hours per day every day, the lifetime of the blades is 2 weeks.

If the lawnmower works for 2.6 hours per day every day, the lifetime of the blades is 2 months.

▲ WARNING

- Do not touch the blades with your bare hands. Put on a pair of work gloves.

HRM1000

- Make sure to press the manual STOP button and press and hold the Ⓞ (Power On/Off) button for 3 seconds to turn the power off before performing the following procedures.

HRM1500, HRM1500 Live, HRM2500, HRM2500 Live

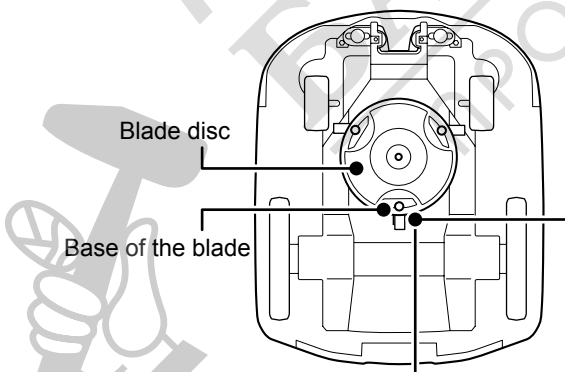
- Make sure to press the manual STOP button and press the Ⓞ (Off) button to turn the power off before performing the following procedures.

NOTE:

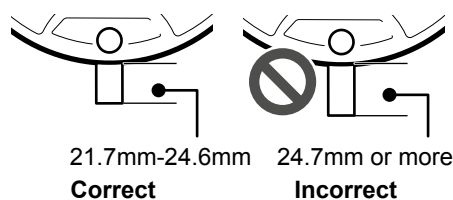
- Hold the lawnmower against a wall for support.
- Do not lift the lawnmower off of the ground while checking it.

Check the blades, nuts and blade disc for problems.

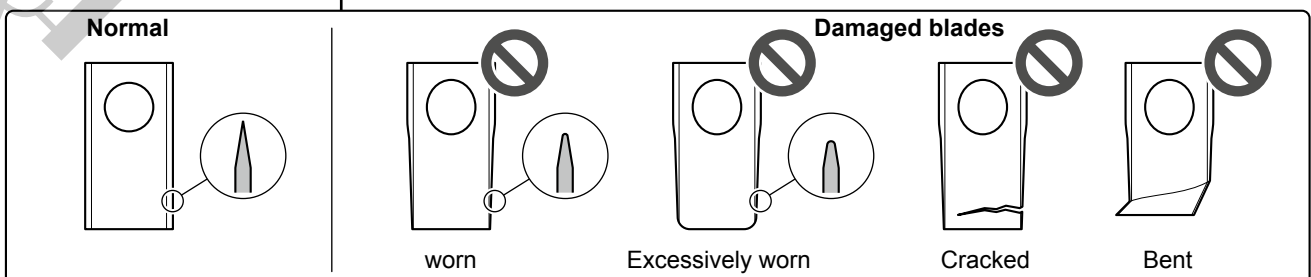
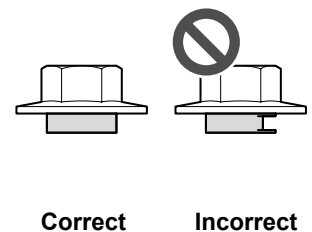
Check item(s)		Action
Blades and nuts	Damage to the blades	Visually inspect the blades. If they are damaged, replace the blades. See "Replacing the blades" (☞ page 114).
	Loosened bases of the blades	Rotate the nuts with your finger to check that they are not loose. If the nuts are loose, tighten them to the specified torque value. See "Replacing the blades" (☞ page 114).
	Abrasions of the holes of blades and abrasions of the shoulders of nuts	Visually inspect the abrasions of the hole of blades and the abrasions of the shoulder of nuts. While mowing, the hole of the blades will widen and the shoulder of the nuts will decrease in size because of abrasions, and there is a danger that the blades will be detached from the blade disc. If they are worn, replace the blades and nuts. See "Replacing the blades" (☞ page 114).
Blade disc	Warping of the blade disc	Rotate the blade disc and visually check it. If it is warped, consult your dealer.



Checking the abrasions of blades and nuts



Checking the abrasions of the shoulders of nuts



Replacing the blades

To replace the blades, perform the procedures below.

▲ WARNING

- Put on a pair of work gloves before performing the following procedures.
- Do not touch the blade while it is spinning. You may be injured if you do so.

NOTE:

- This work requires technical skill and knowledge, as well as special tools. Consult your dealer if you cannot perform the procedures below.
- Before replacing the blades, remove the grass clippings (☞ page 104).
- Always replace the cutting blade without sharpening it. When replacing, be sure to use a new, genuine one.
- Replace all cutting blades at the same time to maintain cutting balance.

Replacement Item(s)	Part number
Blade	72511-VP7-C50
Nut	90305-VP7-C50

1

Turn the power off.
Adjust the height of the blades to position 1 and turn the lawnmower upside down.

2

Hold the base of the blade disc with a 24 mm spanner so that the blade disc does not rotate when you rotate the nuts.

3

Remove the nut from each blade with a 8 mm spanner.

4

Replace the blades, insert each blade through each bolt on the blade disc, and lightly tighten a nut with the 8 mm spanner.

NOTE:

- Tighten the nuts after the shoulders of the nut is securely in the hole of the blade.

5

Tighten the nuts to the specified torque value using a torque wrench.

4.4~6.0 N • m (0.45~0.60 kgf • m, 3.2~4.4 lbf • ft)

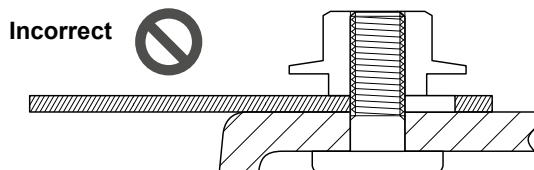
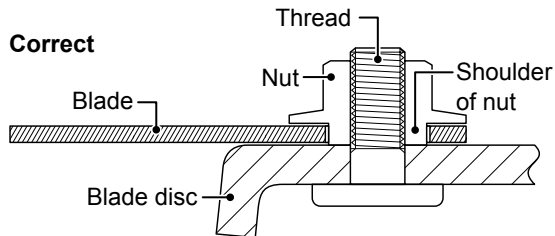
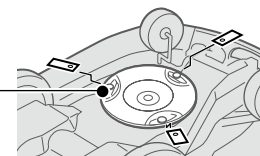
NOTE:

- If you do not have a torque wrench, have your dealer perform the work.
- Use a spanner between the blade disc and the lawnmower body.

6

Check that the blades rotate smoothly. If they do not rotate smoothly, remove and install the nuts again.

Hold the blade disc in place
Insert a spanner between the blade disc holder and the lawnmower body.



9 STORAGE

■ Winter Storage

■ Lawnmower and Docking station

It is very important that your lawnmower and docking station are cleaned thoroughly before placing into storage. The battery should be charged before it is stored in a dry place away from frost and protected from the winter weather.

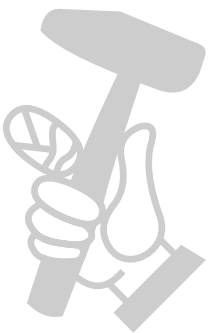
Recommended battery charge level for storage	50 - 70%
Recommended temperature for storage	5 - 20°C

■ Electrical Components

It is strongly recommended that you disconnect the AC adapter over winter leaving only the boundary wire in the ground. Spray electrical contact cleaner on boundary wire terminals before encasing them in a waterproof box (e.g. electrical junction box) to ensure they do not corrode over the winter period. Honda recommends that all electrical components such as the AC adapter should be stored in a dry, frost free environment that is not exposed to the winter weather.

■ Get your lawnmower ready for the new season

Before the winter season has passed and it is time to recommence your lawnmower operation it is strongly recommended that you consult your dealer. An authorised dealer will check that all systems are functioning correctly and that your lawnmower is safe to begin mowing for the forthcoming season.



10 TECHNICAL INFORMATION

Specifications

Model	HRM1000			HRM1500			HRM1500Live			
Description code	MCJF			MCKF			MCLF 			
Type	E	B	S	E	B	S	EC	BC	SC	
Length	655 mm									
Width	535 mm									
Height	270 mm									
Weight	11.3 kg			11.3 kg			11.5 kg			
Electrical system										
Battery	Li-ion 21.6 V / 1900 mAh									
AC adapter	Input	AC 230 V	AC 240 V	AC 230 V	AC 230 V	AC 240 V	AC 230 V	AC 230 V	AC 240 V	AC 230 V
	Output	1.5 A / 40 V								
Extension cord	ICC 2X1.5 mm ² , conform with H07RN-F									
Mowing										
Blade motor speed	2500 ⁰ ₋₁₀₀ min ⁻¹ (Normal mode) / 2200 ⁰ ₋₁₀₀ min ⁻¹ (Quiet mode)									
Cutting height	20-60 mm									
Cutting width	22 cm									
Boundary wire										
Maximum possible length (Option parts)	400 m									
Frequency band(s)	2.5 kHz - 5 kHz									
Maximum radio- frequency power	< 82 dBμA/m @10m									
Communication										
Bluetooth® class	2 (10 mW)									
Bluetooth® version	4.0									
Frequency band(s)	2402MHz - 2480MHz									
Maximum radio- frequency power	< 20 mW									
Noise										
Sound pressure level at operator's ears EN50636-2-107:2015	Measured level 48 dB(A) Measuring uncertainty +2.5 dB(A) (Not exceeding 70 dB(A))									
Sound power level EN50636-2-107:2015	Measured level 55.9 dB(A) Measuring uncertainty +2.5 dB(A)									
Garden size										
Maximum area	1000m ²			1500m ²			1500m ²			
Recommended area	800m ²			1000m ²			1000m ²			

Model	HRM2500			HRM2500Live			
Description code	MCMF			MCNF			
Type	E	B	S	EC	BC	SC	
Length	655 mm						
Width	535 mm						
Height	270 mm						
Weight	11.6 kg			11.8 kg			
Electrical system							
Battery	Li-ion 21.6 V / 3800 mAh						
AC adapter	Input	AC 230 V	AC 240 V	AC 230 V	AC 230 V	AC 240 V	AC 230 V
	Output	1.5 A / 40 V					
Extension cord	ICC 2X1.5 mm ² , conform with H07RN-F						
Mowing							
Blade motor speed	2500 ⁰ ₋₁₀₀ min ⁻¹ (Normal mode) / 2200 ⁰ ₋₁₀₀ min ⁻¹ (Quiet mode)						
Cutting height	20-60 mm						
Cutting width	22 cm						
Boundary wire							
Maximum possible length (Option parts)	800 m						
Frequency band(s)	2.5 kHz - 5 kHz						
Maximum radio- frequency power	< 82 dBμA/m @10m						
Communication							
Bluetooth® class	2 (10 mW)						
Bluetooth® version	4.0						
Frequency band(s)	2402MHz - 2480MHz						
Maximum radio- frequency power	< 20 mW						
Noise							
Sound pressure level at operator's ears EN50636-2-107:2015	Measured level 48 dB(A) Measuring uncertainty +2.5 dB(A) (Not exceeding 70 dB(A))						
Sound power level EN50636-2-107:2015	Measured level 55.9 dB(A) Measuring uncertainty +2.5 dB(A)						
Garden size							
Maximum area	3000m ²			3000m ²			
Recommended area	2000m ²			2000m ²			

11 Appendix

Major Honda Distributor Addresses

AUSTRIA

Honda Motor Europe Ltd
 Hondastraße 1
 2351 Wiener Neudorf
 Tel.: +43 (0)2236 690 0
 Fax: +43 (0)2236 690 480
<http://www.honda.at>
 ✉ HondaPP@honda.co.at

BALTIC STATES

(Estonia/Latvia/Lithuania)
NCG Import Baltics OU
 Meistri 12
 13517 Tallinn Harju County Estonia
 Tel.: +372 651 7300
 Fax: +372 651 7301
 ✉ info.baltic@ncgimport.com

BELARUS

JV "Scanlink" Ltd.
 Montazhnikov lane 4th, 5-16
 Minsk 220019
 Republic of Belarus
 tel. +375 712349999
 fax +375 172380404
 ✉ honda@scanlink.by

BELGIUM

Honda Motor Europe Ltd
 Doornveld 180-184
 1731 Zellik
 Tel.: +32 2620 10 00
 Fax: +32 2620 10 01
<http://www.honda.be>
 ✉ bh_pe@honda-eu.com

BULGARIA

Premium Motor Ltd
 Andrey Lyapchev Blvd no 34
 1797 Sofia
 Bulgaria
 Tel.: +3592 423 5879
 Fax: +3592 423 5879
<http://www.hondamotor.bg>
 ✉ office@hondamotor.bg

CROATIA

AS POWER EQUIPMENT d.o.o.
 Brezence 2
 SI-8216 Mirna Peč
 Tel.: +386 7 777 00 45
<http://as-powerequipment.com>
 ✉ info@as-powerequipment.com

CYPRUS

Powerline Products Ltd
 Cyprus - Nicosia
 Vasiliias 18 2232 Latsia
 Tel.: 0035799490421
 ✉ info@powerlinecy.com
<http://www.powerlinecy.com>

CZECH REPUBLIC

BG Technik cs, a.s.
 U Zavodiste 251/8
 15900 Prague 5 - Velka Chuchle
 Tel.: +420 2 838 70 850
 Fax: +420 2 667 111 45
<http://www.honda-stroje.cz>

DENMARK

TIMA A/S
 Ryttermarken 10
 DK-3520 Farum
 Tel.: +45 36 34 25 50
 Fax: +45 36 77 16 30
<http://www.tima.dk>

FINLAND

OY Brandt AB.
 Tuupakantie 7B
 01740 Vantaa
 Tel.: +358 207757200
 Fax: +358 9 878 5276
<http://www.brandt.fi>

FRANCE

Honda Motor Europe Ltd
 Division Produit d'Equipement
 Parc d'activités de Pariest,
 Allée du 1er mai
 Croissy Beaubourg BP46, 77312
 Marne La Vallée Cedex 2
 Tel.: 01 60 37 30 00
 Fax: 01 60 37 30 86
<http://www.honda.fr>
 ✉ espace-client@honda-eu.com

GERMANY

Honda Deutschland
Niederlassung der Honda Motor
Europe Ltd.
 Hanauer Landstraße 222-224
 D-60314 Frankfurt
 Tel.: 01805 20 20 90
 Fax: +49 (0)69 83 20 20
<http://www.honda.de>
 ✉ info@post.honda.de

GREECE

Technellas S.A.
 92 Athinon Ave
 10442 Athens, Greece
 Tel: +30 210 519 31 10
 Fax: +30 210 519 31 14
 ✉ mail@technellas.gr

HUNGARY

MP Motor Co., Ltd.
 Kamaraerdei ut 3.
 2040 Budaors
 Tel.: +36 23 444 971
 Fax: +36 23 444 972
<http://www.hondakisgepek.hu>
 ✉ info@hondakisgepek.hu

IRELAND

Two Wheels Ltd
 M50 Business Park, Ballymount
 Dublin 12
 Tel.: +353 1 4381900
 Fax: +353 1 4607851
<http://www.hondaireland.ie>
 ✉ sales@hondaireland.ie

ISRAEL

Mayer's Cars and Trucks Co.Ltd. -
Honda Division
 Shevach 5, Tel Aviv , 6777936
 Israel
 +972-3-6953162
 ✉ OrenBe@mct.co.il

ITALY

Honda Motore Europe Ltd
 Via della Cecchignola, 13
 00143 Roma
 Tel.: +848 846 632
 Fax: +39 065 4928 400
<http://www.hondaitalia.com>
 ✉ info.power@honda-eu.com

NORTH MACEDONIA

AS POWER EQUIPMENT d.o.o.
 Brezence 2
 SI-8216 Mirna Peč
 Tel.: +386 7 777 00 45
<http://as-powerequipment.com>
 ✉ info@as-powerequipment.com

MALTA

The Associated Motors
Company Ltd.
 New Street in San Gwakklin Road
 Mriehel Bypass, Mriehel QRM17
 Tel.: +356 21 498 561
 Fax: +356 21 480 150
 ✉ mgalea@gasanzammit.com

NORWAY

Berema AS
 Svarthagsveien 8
 1543 Vestby
 Tel.: +47 64 86 05 00
 Fax: +47 64 86 05 49
<http://www.berema.no>
 ✉ berema@berema.no

POLAND

Aries Power Equipment
 Puławska 467
 02-844 Warszawa
 Tel.: +48 (22) 861 43 01
 Fax: +48 (22) 861 43 02
<http://www.ariespower.pl>
<http://www.mojahonda.pl>
 ✉ info@ariespower.pl

PORTUGAL

GROW Productos de Forza
Portugal
 Rua Fontes Pereira de Melo, 16
 Abrunheira, 2714-506 Sintra
 Tel.: +351 211 303 000
 Fax: +351 211 303 003
<http://www.grow.com.pt>
 ✉ geral@grow.com.pt

ROMANIA

Agrisorg SRL
 Sacadat Str Principala
 Nr 444/A Jud. Bihor
 Romania
 Tel.: (+4) 0259 458 336
 ✉ info@agrisorg.com

SERBIA & MONTENEGRO

AS POWER EQUIPMENT d.o.o.
 Brezence 2
 SI-8216 Mirna Peč
 Tel.: +386 7 777 00 45
<http://as-powerequipment.com>
 ✉ info@as-powerequipment.com

SLOVAK REPUBLIC

Honda Motor Europe Ltd
Slovensko, organizačná zložka
 Prievozska 6 821 09 Bratislava
 Tel.: +421 2 32131111
 Fax: +421 2 32131112
<http://www.honda.sk>

SLOVENIA

AS POWER EQUIPMENT d.o.o.
 Brezence 2
 SI-8216 Mirna Peč
 Tel.: +386 7 777 00 45
<http://as-powerequipment.com>
 ✉ info@as-powerequipment.com

SPAIN & all Provinces

Greens Power Products, S.L.
 Poligono Industrial Congost -
 Av Ramon Ciurans n°2
 08530 La Garriga - Barcelona
 Tel.: +34 93 860 50 25
 Fax: +34 93 871 81 80
<http://www.hondaencasa.com>

SWEDEN

Honda Motor Europe Ltd filial
Sverige
 Box 31002 - Långhusgatan 4
 215 86 Malmö
 Tel.: +46 (0)40 600 23 00
 Fax: +46 (0)40 600 23 19
<http://www.honda.se>
 ✉ hpesinfo@honda-eu.com

SWITZERLAND

Honda Motor Europe Ltd.
Succursale de Satigny/Genève
 Rue de la Bergère 5
 1242 Satigny
 Tel.: +41 (0)22 989 05 00
 Fax: +41 (0)22 989 06 60
<http://www.honda.ch>

TURKEY

Anadolu Motor Uretim Ve
Pazarlama As
 Sekerpinar Mah
 Albayrak Sok No 4
 Cayirova 41420
 Kocaeli
 Tel.: +90 262 999 23 00
 Fax: +90 262 658 94 17
<http://www.anadolumotor.com.tr>
 ✉ antor@antor.com.tr

UKRAINE

Dnipro Motor LLC
 3, Bondarsky Alley,
 Kyiv, 04073, Ukraine
 Tel.: +380 44 537 25 76
 Fax: +380 44 501 54 27
 ✉ igor.lobunets@honda.ua

UNITED KINGDOM

Honda Motor Europe Ltd
 Cain Road
 Bracknell
 Berkshire
 RG12 1 HL
 Tel.: +44 (0)845 200 8000
<http://www.honda.co.uk>

“UK Declaration of Conformity” CONTENT OUTLINE

UK Declaration of Conformity

The undersigned, *1, representing the manufacturer, herewith declares that the machinery described below fulfils all the relevant provisions of:

- The Supply of Machinery (Safety) Regulations 2008
- The Electromagnetic Compatibility Regulations 2016
- The Electrical Equipment (Safety) Regulations 2016
- The Radio Equipment Regulations 2017
- The Restriction of the Use of Certain Hazardous Substances in Electrical and Electronic Equipment Regulations 2012

Description of the machinery

- Product: Robotic lawnmower
- Function: Cutting of grass

Model	Type	Serial number
HRM1000	B	
HRM1500	B	
HRM1500	BC	
HRM2500	B	
HRM2500	BC	
HRM4000	BC	

Manufacturer

- Honda France Manufacturing S.A.S.
Pôle 45 - Rue des Châtaigniers
45140 ORMES – France

Authorized representative and able to compile the technical documentation

- Honda Motor Europe Ltd
Cain Road, Bracknell, Berkshire,
RG12 1HL, United Kingdom

References to applied standards

EN 60335-1:2012 / AC:2014 / A11:2014 / A13:2017 / A1:2019 / A2:2019 / A14:2019 / A15:2021	EN IEC 62311:2020
EN 50636-2-107:2015 / A1:2018 / A2 :2020 / A3:2021	EN 300 328 V2.2.2 : 2019-07
EN IEC 55014-1:2021	EN 301 489-1 V2.2.3 : 2019-11
EN IEC 55014-2:2021	EN 301 489-17 V3.2.4 : 2020-09
EN IEC 61000-3-2:2019 / A1:2021	EN 301 489-19 V2.2.1 : 2022-09 (Type : BC)
EN 61000-3-3:2013 / A1:2019 / A2:2021 / AC:2022-01	EN 301 489-52 V1.2.1 : 2021-11 (Type : BC)
	EN 301 908-1 V15.2.1 : 2023-01 (Type : BC)
	EN 301 908-2 V13.1.1 (2020-06) (Type : BC)
	EN 301 908-13 V13.2.1 : 2022-02 (Type : BC)
	EN 303 447 V1.3.1 : 2022-07
	EN 303 413 V1.2.1 : 2021-04 (Type : BC)

The Radio Equipment Regulations 2017

- The UK approved body (TECHNOLOGY INTERNATIONAL (EUROPE) LTD, 0673) performed an UK-type examination and issued the UK-type examination certificate: *1

Done at:

ORMES , FRANCE

Date:

*1

*1

President

Honda France Manufacturing S.A.S.

*1: see original UK Declaration of Conformity.

“EC Declaration of Conformity” CONTENT OUTLINE

EC Declaration of Conformity

1. The undersigned, *1, representing the manufacturer, herewith declares that the machinery described below fulfils all the relevant provisions of:

- Directive 2006/42/EC on machinery
- Directive 2014/30/EU on electromagnetic compatibility
- Directive 2014/35/EU relating to electrical equipment designed for use within certain voltage limits
- Directive 2014/53/EU on radio equipment
- Directive 2011/65/EU - (EU) 2015/863 on the restriction of the use of certain hazardous substances in electrical and electronic equipment

2. Description of the machinery

- a) Product: Robotic lawnmower
 b) Function: Cutting of grass

c) Model	d) Type	e) Serial number
HRM1000	E, S	
HRM1500	E, S	
HRM1500	EC, SC	
HRM2500	E, S	
HRM2500	EC, SC	
HRM4000	EC, SC	

3. Manufacturer and able to compile the technical documentation

- Honda France Manufacturing S.A.S.
 Pôle 45 - Rue des Châtaigniers
 45140 ORMES - FRANCE

4. References to applied standards

EN 60335-1:2012 / AC:2014 / A11:2014 / A13:2017 / A1: 2019 / A2:2019 / A14:2019 / A15:2021	EN IEC 62311:2020
EN 50636-2-107:2015 / A1:2018 / A2 :2020 / A3:2021	EN 300 328 V2.2.2 : 2019-07
EN IEC 55014-1:2021	EN 301 489-1 V2.2.3 : 2019-11
EN IEC 55014-2:2021	EN 301 489-17 V3.2.4 : 2020-09
EN IEC 61000-3-2:2019 / A1:2021	EN 301 489-19 V2.2.1 : 2022-09 (Type : EC, SC)
EN 61000-3-3:2013 / A1:2019 / A2:2021 / AC:2022-01	EN 301 489-52 V1.2.1 : 2021-11 (Type : EC, SC)
	EN 301 908-1 V15.2.1 : 2023-01 (Type : EC, SC)
	EN 301 908-2 V13.1.1 (2020-06) (Type : EC, SC)
	EN 301 908-13 V13.2.1 : 2022-02 (Type : EC, SC)
	EN 303 447 V1.3.1 : 2022-07
	EN 303 413 V1.2.1 : 2021-04 (Type : EC, SC)

5. 2014/53/EU: Annex III (Module B, EU-type examination)

- The notified body (VDE, 0366) performed EU-type examination and issued the EU-type examination certificate: *1

6. Done at: ORMES , FRANCE

7. Date: *1

 *1
 President
 Honda France Manufacturing S.A.S.

*1: see original EC Declaration of Conformity.

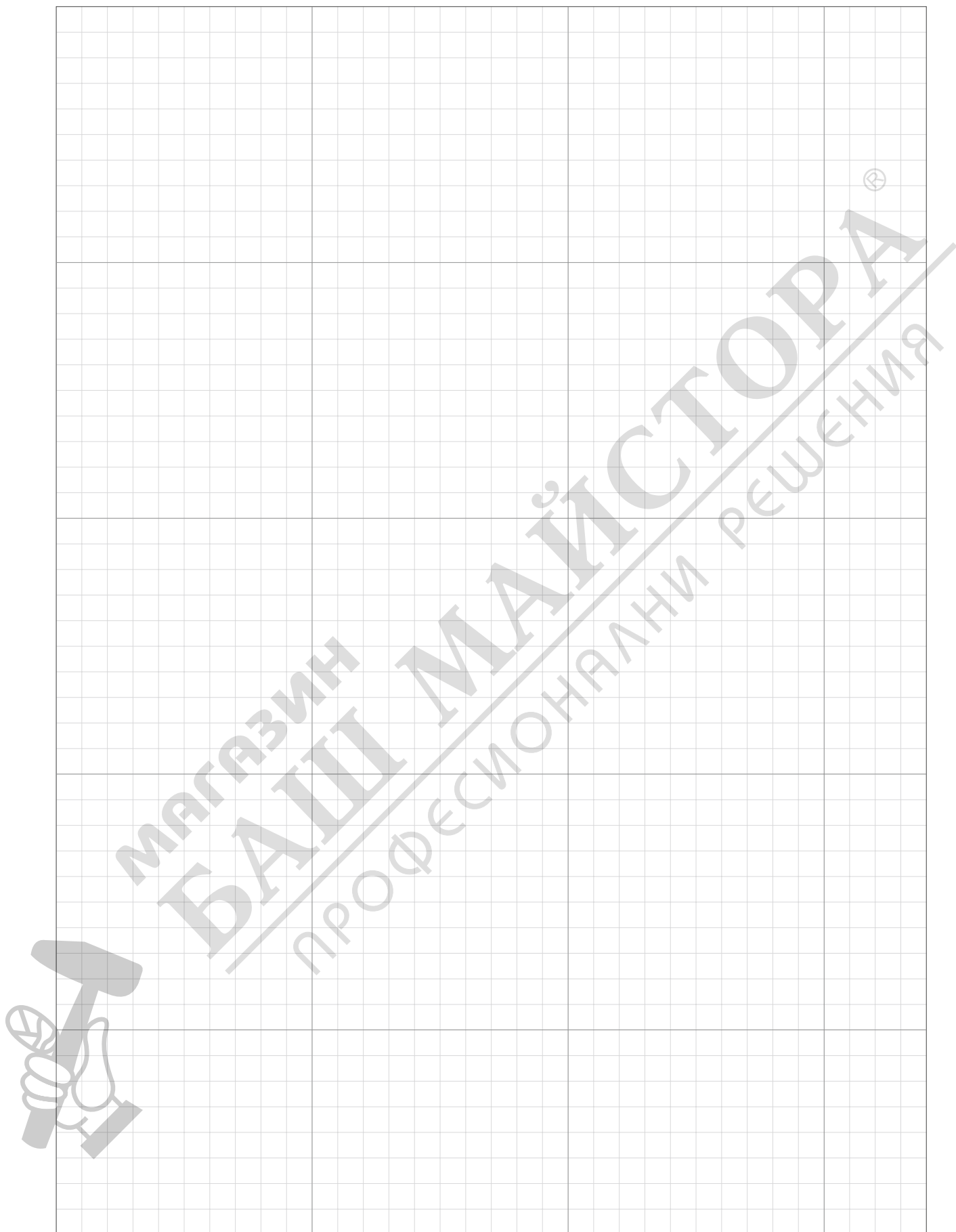
<p>Français (French) Déclaration CE de Conformité 1. Le soussigné, *1, représentant du constructeur, déclare que la machine décrit ci-dessous répond à toutes les dispositions applicables de * Directive Machine 2006/42/CE * Directive 2014/30/UE en lien avec la compatibilité électromagnétique * Directive 2014/35/UE relatives au matériel électrique destiné à être employé dans certaines limites de tension * Directive 2014/53/UE concernant les équipements hertziens * Directive 2011/65/UE - (UE) 2015/863 relative à la limitation de l'utilisation de certaines substances dangereuses dans les équipements électriques et électroniques 2. Description de la machine a) Produit: Tondeuse à gazon robotisée b) Fonction : couper de l'herbe (tondre) c) Modèle d) Type e) Numéro de série 3. Constructeur et en charge des éditions de documentation techniques 4. Référence aux normes appliquées 5. 2014/53/UE : ANNEXE III (Module B, Examen UE de type) l'organisme notifié (VDE, 0366) a réalisé Examen UE de type et a délivré le certificat d'examen UE de type: 6. Fait à 7. Date</p>	<p>Italiano (Italian) Dichiarazione CE di Conformità 1. Il sottoscritto, *1 in rappresentanza del costruttore, dichiara qui di seguito che la macchina sotto descritta soddisfa tutte le disposizioni pertinenti delle: * Direttiva macchine 2006/42/CE * Direttiva 2014/30/UE sulla compatibilità elettromagnetica * Direttiva 2014/35/UE relative al materiale elettrico destinato ad essere adoperato entro taluni limiti di tensione * Direttiva 2014/53/UE riguardante le apparecchiature radio * Direttiva 2011/65/UE - (UE) 2015/863 sulla restrizione dell'uso di determinate sostanze pericolose nelle apparecchiature elettriche ed elettroniche 2. Descrizione della macchina a) Prodotto: Rasaerba robotizzato b) Funzione : Taglio di erba c) Modello d) Tipo e) Numero di serie 3. Costruttore e competente per la compilazione della documentazione tecnica 4. Riferimento alle norme applicate 5. 2014/53/UE: ALLEGATO III (Modulo B, Esame UE del tipo) l'organismo notificato (VDE, 0366) ha effettuato Esame UE del tipo e rilasciato il certificato di esame UE del tipo: 6. Fatto a 7. Data</p>	<p>Deutsch (German) EG-Konformitätserklärung 1. Der Unterzeichner, *1 der den Hersteller vertritt, erklärt hiermit dass das hierunter genannte Maschine allen einschlägigen Bestimmungen der * entspricht. * Maschinenrichtlinie 2006/42/EG * Richtlinie 2014/30/UE über die elektromagnetische Verträglichkeit * Richtlinie 2014/35/UE betreffend elektrische Betriebsmittel zur Verwendung innerhalb bestimmter Spannungsgrenzen * Richtlinie 2014/53/UE über Funkanlagen * Richtlinie 2011/65/UE - (EU) 2015/863 zur Beschränkung der Verwendung bestimmter gefährlicher Stoffe in Elektro- und Elektronikgeräten 2. Beschreibung der Maschine a) Produkt: Rasenmäher Roboter b) Funktion : Gras schneiden c) Modell d) Typ e) Seriennummer 3. Hersteller und in der Position, die technische Dokumentation zu erstellen 4. Verweis auf aufwendbare Standards 5. 2014/53/UE: ANHANG III (Modul B, EU-Baumusterprüfung) Die notifizierte Stelle (VDE, 0366) hat EU-Baumusterprüfung und folgende EU-Baumusterprüfbescheinigung ausgestellt: 6. Ort 7. Datum</p>
<p>Nederlands (Dutch) EG-verklaring van overeenstemming 1. Ondergetekende, *1, vertegenwoordiger van de constructeur, verklaart hiermee dat het hieronder beschreven machine voldoet aan alle toepasselijke bepalingen van: * Richtlijn 2006/42/EG betreffende machines * Richtlijn 2014/30/UE betreffende elektromagnetische overeenstemming * Richtlijn 2014/35/UE inzake elektrisch materiaal bestemd voor gebruik binnen bepaalde spanningsgrenzen * Richtlijn 2014/53/UE betreffende radioapparatuur * Richtlijn 2011/65/UE - (EU) 2015/863 betreffende beperking van het gebruik van bepaalde gevaarlijke stoffen in elektrische en elektronische apparatuur 2. Beschrijving van de machine a) Product: Robotmaaier b) Functie : gras maaien c) Model d) Type e) Serienummer 3. Fabrikant en in staat om de technische documentatie samen te stellen 4. Referentie voor toegepaste normen 5. 2014/53/UE: BIJLAGE III (Module B, EU-typeonderzoek) de aangemelde instantie (VDE, 0366) heeft een EU-typeonderzoek uitgevoerd en het certificaat van EU-typeonderzoek afgegeven: 6. Plaats 7. Datum</p>	<p>Dansk (Danish) EF OVERENSTEMMELSEERKLÆRING 1. UNDERTEGNEDE, *1, SOM REPRÆSENTERER PRODU-CENTEN, ERKLÆRER HERMED AT MASKINEN, SOM ER BESKRIVET NEDENFOR, OPFYLDER ALLE RELEVANTE BESTEMMELSER IFØLGE: * MASKINDIREKTIV 2006/42/EF * Direktiv 2014/30/UE om elektromagnetisk kompatibilitet * Direktiv 2014/35/UE lovgivning om elektrisk materiel bestemt til anvendelse inden for visse spændingsgrænser * Direktiv 2014/53/UE om radioudstyr * direktiv 2011/65/UE - (EU) 2015/863 om begrænsning af anvendelsen af visse farlige stoffer i elektrisk og elektronisk udstyr 2. BESKRIVELSE AF PRODUKTET a) Produkt: Robotplæneklipper b) ANVENDELSE : Græsklipning c) Model d) TYPE e) SERIENUMMER 3. PRODUCENT OG I STAND TIL AT UDARBEJDE DEN TEKNISKE DOKUMENTATION 4. Henvisning til anvendte standarder 5. 2014/53/UE: BILAG III (Modul B, EU-typeafprøvning) det bemyndigede organ (VDE, 0366) har foretaget EU-typeafprøvning og udstedt EU-typeafprøvningsattest: 6. STED 7. DATO</p>	<p>Ελληνικά (Greek) ΕΚ-Δήλωση συμμόρφωσης 1. Ο κάτωθι υπογραμμισμένος, *1, εκπροσωπώντας τον κατασκευαστή, δηλώνει ότι το παρακάτω περιγραφόμενο όχημα πληροί όλες τις σχετικές προδιαγραφές του: * Οδηγία 2006/42/ΕΚ για μηχανές * Οδηγία 2014/30/ΕΕ σχετικά με την ηλεκτρομαγνητική συμβατότητα * Οδηγία 2014/35/ΕΕ αναφερόμενων στο ηλεκτρολογικό υλικό που προορίζεται να χρησιμοποιηθεί εντός ορισμένων ορίων τάσεως * Οδηγία 2014/53/ΕΕ σχετικά με το ραδιοεξοπλισμό * Οδηγία 2011/65/ΕΕ - (ΕΕ) 2015/863 για τον περιορισμό της χρήσης ορισμένων επικίνδυνων ουσιών σε ηλεκτρικό και ηλεκτρονικό εξοπλισμό 2. Περιγραφή μηχανήματος a) προϊόν: Αυτόματο χλοοκοπτικό b) Λειτουργία : για κόψιμο γρασιδιού c) Μοντέλο d) Τύπος e) Αριθμός σειράς παραγωγής 3. Κατασκευαστής και να είναι σε θέση να καταρτίσει τον τεχνικό φάκελο 4. Παραπομπή στα ισχύοντα πρότυπα 5. 2014/53/ΕΕ: ΠΑΡΑΡΤΗΜΑ III (Ενότητα Β, Εξέταση τύπου ΕΕ) ο κοινοποιημένος οργανισμός (VDE, 0366) πραγματοποίησε Εξέταση τύπου ΕΕ και εξέδωσε το πιστοποιητικό εξέτασης τύπου ΕΕ: 6. Η δοκιμή έγινε 7. Ημερομηνία</p>
<p>Svenska (Swedish) EG-försäkran om överensstämmelse 1. Undertecknad, *1, representant för tillverkaren, deklarerar härmed att maskinen beskriven nedan fullföljer alla relevanta bestämmelser enligt: * Direktiv 2006/42/EG gällande maskiner * Direktiv 2014/30/UE på elektromagnetisk kompatibilitet * Direktiv 2014/35/UE om elektrisk utrustning avsedd för användning inom vissa spänninggränser * Direktiv 2014/53/UE om radioustrutning * direktiv 2011/65/UE - (EU) 2015/863 om begränsning av användning av vissa farliga ämnen i elektrisk och elektronisk utrustning 2. Maskinbeskrivning a) Produkt: Robotgräsklippare b) Funktion : gräsklippning c) Modell d) Typ e) Serienummer 3. Tillverkare och ska kunna sammanställa teknisk dokumentationen. 4. Referens för tillämpad standard 5. 2014/53/UE: BILAGA III (Modul B, EU-typkontroll) det anmälda organet (VDE, 0366) har utfört EU-typkontroll och utfärdat EU-typgodkänningsintyg 6. Utfärdat vid 7. Datum</p>	<p>Español (Spanish) Declaración de Conformidad CE 1. El firmante, *1, en representación del fabricante, adjunto declara que la máquina abajo descrita, cumple las cláusulas relevantes de: * Directiva 2006/42/CE de maquinaria * Directiva 2014/30/UE sobre compatibilidad electromagnética * Directiva 2014/35/UE sobre el material eléctrico destinado a utilizarse con determinados límites de tensión * Directiva 2014/53/UE sobre equipos radioeléctricos * Directiva 2011/65/UE - (UE) 2015/863 sobre restricciones a la utilización de determinadas sustancias peligrosas en aparatos eléctricos y electrónicos 2. Descripción de la máquina a) Producto: Robot cortacésped b) Función : Cortar el césped c) Modelo d) Tipo e) Número de serie 3. Fabricante que puede compilar el expediente técnico 4. Referencia a normas aplicadas 5. 2014/53/UE: ANEXO III (Módulo B, Examen UE de tipo) El organismo notificado (VDE, 0366) ha efectuado Examen UE de tipo y expedido el certificado de examen UE de tipo: 6. Realizado en 7. Fecha OBS421 DECLARACIÓN UE DE CONFORMIDAD SIMPLIFICADA Por la presente, u-blox AG declara que el tipo de equipo radioeléctrico</p>	<p>Română (Romanian) CE-Declaratie de Conformitate 1. Subsemnatul *1, reprezentant producătorul, declar prin prezenta faptul ca echipamentul descris mai jos îndeplinește toate condițiile necesare din: * Directiva 2006/42/CE privind echipamentul * Directiva 2014/30/UE privind compatibilitatea electromagnetică * Directiva 2014/35/UE cu privire la echipamentele electrice destinate utilizării în cadrul unor anumite limite de tensiune * Directiva 2014/53/UE privind echipamentele hertziene * Directiva 2011/65/UE - (UE) 2015/863 privind restricțiile de utilizare a anumitor substanțe periculoase în echipamentele electrice și electronice 2. Descrierea echipamentului a) Produsul: Masina de tuns robotizata b) Domeniu de utilizare : tunderea ierbi c) Model d) Tip e) Serie produs 3. Producator și abilitat să realizeze documentație tehnică 4. Referință la standardele aplicate 5. 2014/53/UE: ANEXA III (Modulul B, Examinarea UE de tip) organismul notificat (VDE, 0366) a efectuat Examinarea UE de tip și a emis certificatul de examinare UE de tip: 6. Emisa la 7. Data</p>
<p>Português (Portuguese) Declaração CE de Conformidade 1. O abaixo assinado, *1, representante do fabricante, declara que a máquina abaixo descrita cumpre todas as estipulações relevantes da: * Directiva 2006/42/CE de máquina * Directiva 2014/30/UE relativa à compatibilidade electromagnética * Directiva 2014/35/UE relativa à harmonização das legislações dos Estados-Membros no domínio do material eléctrico destinado a ser utilizado dentro de certos limites de tensão * Directiva 2014/53/UE relativa aos equipamentos de rádio * Directiva 2011/65/UE - (UE) 2015/863 relativa à restrição do uso de determinadas substâncias perigosas em equipamentos eléctricos e electrónicos 2. Descrição da máquina a) Produto: Robot corta relva b) Função : corte de relva c) Modelo d) Tipo e) Número de série 3. Fabricante com capacidade para compilar documentação técnica 4. Referência às normas aplicadas 5. 2014/53/UE: ANEXO III (Módulo B, Exame UE de tipo) o organismo notificado: (VDE, 0366) Efetuou Exame UE de tipo e emitiu o certificado de exame UE de tipo: 6. Feito em 7. Data</p>	<p>Polski (Polish) Deklaracja Zgodności WE 1. Niżej podpisany *1, reprezentujący producenta, niniejszym deklaruje, że urządzenie opisane poniżej spełnia wszelkie właściwe postanowienia: * Dyrektywę maszynową 2006/42/WE * Dyrektywę 2014/30/UE Kompatybilności Elektromagnetycznej * Dyrektywę 2014/35/UE odnoszącej się do sprzętu elektrycznego przewidzianego do stosowania w określonych granicach napięcia * Dyrektywę 2014/53/UE w sprawie urządzeń radiowych * Dyrektywę 2011/65/UE - (UE) 2015/863 w sprawie ograniczenia stosowania niektórych niebezpiecznych substancji w sprzęcie elektrycznym i elektronicznym 2. Opis urządzenia: a) Produkt: Robot koszący b) Funkcja: ścinanie trawy c) Model d) Typ e) Numer seryjny 3. Producent oraz osoba upoważniona do przygotowania dokumentacji technicznej 4. Odniesienie do zastosowanych norm 5. 2014/53/UE: ZAŁĄCZNIK III (Moduł B, Badanie typu UE) jednostka notyfikowana (VDE, 0366) przeprowadziła Badanie typu UE i wydała certyfikat badania typu UE: 6. Miejsce 7. Data</p>	<p>Suomi / Suomen kieli (Finnish) EY-VAATIMUSTENMUKAISUUSVAKUUTUS 1. Allekirjoittanut valmistajan edustaja *1 vakuuttaa täten, että alla mainittu kone/tuote täyttää kaikki seuraavia määräyksiä: * Konedirektiivi 2006/42/EY * Direktiivi 2014/30/UE sähkömagneettinen yhteensopivuus * Direktiivi 2014/35/UE tiettyjä jännitealueella toimivia sähkölaitteita koskevan jäsenvaltioiden lainsäädännön lähentämisestä * Direktiivi 2014/53/UE radiolaitteista * direktiivi 2011/65/UE - (EU) 2015/863 tiettyjen vaarallisten aineiden käytön rajoittamisesta sähkö- ja elektroniikkalaitteissa 2. TUOTTEEN KUVAUS a) Tuote: Robottiruohonleikkuri b) Toiminto : ruohon leikkaus c) Malli d) TYYPPI e) SARJANUMERO 3. Valmistaja ja teknisten dokumenttien laatia 4. Valmistajan edustaja ja teknisten dokumenttien laatia 5. 2014/53/UE: LIITE III (Moduuli B, EU-tyyppitarkastus) ilmoitettu laitos (VDE, 0366) suoritti EU-tyyppitarkastus ja antoi EU-tyyppitarkastustodistuksen: 6. TEHTY 7. PÄIVÄMÄÄRÄ</p>

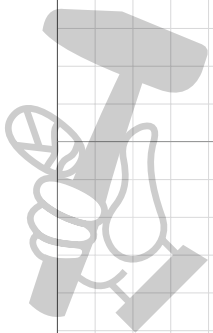
<p>Magyar (Hungarian) EK-megfelelőségi nyilatkozata 1. Alulírott *1, mint a gyártó képviselője nyilatkozom, hogy az általunk gyártott gép megfelel az összes, alább felsorolt direktívának: * 2006/42/EK Direktívának berendezésekre * Irányelv 2014/30/EU megfelelnek az elektromágneses * Irányelv 2014/35/EU a meghatározott feszültséghatáron belüli használatra elektromos berendezésekre * 2014/53/EU irányelve a rádióberendezésekről * Tanács 2011/65/EU - (EU) 2015/863 egyes veszélyes anyagok elektromos és elektronikus berendezésekben való alkalmazásának korlátozásáról 2. A gép leírása a) Termék: Robotfűnyíró b) Funkció : fű levágása c) Modell d) Típus e) Sorozatszám 3. Gyártó és képes összeállítani a műszaki dokumentációt. 4. Referencia az alkalmazott szabványokhoz 5. 2014/53/EU: III. MELLÉKLET (B modul, EU-típusvizsgálat) A(z) (VDE, 0366) bejelentett szervezet elvégezte a(z) EU-típusvizsgálat, és a következő EU-típusvizsgálati tanúsítványt adta ki: 6. Keltetés helye 7. Keltetés ideje</p>	<p>Cestina (Czech) ES – Prohlášení o shodě 1. Zástupce výrobce, *1 svým podpisem potvrzuje, že stroj popsaný níže splňuje požadavky příslušných opatření: * Směrnice 2006/42/ES pro strojní zařízení * Směrnice 2014/30/EU týkající se elektromagnetické kompatibility * Směrnice 2014/35/EU týkající se elektrických zařízení určených pro používání v určitých mezích napětí * Směrnice 2014/53/EU o rádiových zařízeních * Rady 2011/65/EU - (EU) 2015/863 o omezení používání některých nebezpečných látek v elektrických a elektronických zařízeních 2. Popis zařízení a) Výrobek: Robotická sekačka b) Funkce : Sekání trávy c) Model d) Typ e) Výrobní číslo 3. Výrobce a osoba pověřená kompletní technické dokumentace 4. Odkaz na platné standardy 5. 2014/53/EU: PŘÍLOHA III (Modul B, EU přezkoušení typu) oznámený subjekt (VDE, 0366) provedl EU přezkoušení typu a vydal certifikát EU přezkoušení typu: 6. Podepsáno v 7. Datum</p>	<p>Latviešu (Latvian) EK atbilstības deklarācija 1. Zemāk minētais *1, kā ražotāja pārstāvis ar šo apstiprina, ka zemāk aprakstītie mašīna, atbilst visām zemāk norādīto direktīvu sadaļām: * Direktīva 2006/42/EK par mašīnām * Direktīva 2014/30/ES par elektromagnētisko saderību * Direktīva 2014/35/ES uz elektroķērtām, kas paredzētas lietošanai noteiktās sprieguma robežās * Direktīva 2014/53/ES par radioiekārtām * Direktīva 2011/65/ES - (ES) 2015/863 par dažādu bīstamu vielu izmantošanas ierobežošanu elektriskās un elektroniskās iekārtās 2. Iekārtas apraksts a) Produkts: Robotizētie zāles pļāvēji b) Funkcija : zāles pļaušana c) Modelis d) Tips e) Sērijas numurs 3. Ražotājs, kas spēj sastādīt tehnisko dokumentāciju 4. Atsaucē uz piemērotajiem standartiem 5. 2014/53/ES: III PIELIKUMS (B modulis, ES tipa pārbaude) paziņotā struktūra (VDE, 0366) ir veikusi ES tipa pārbaude un izdevusi ES tipa pārbaudes sertifikātu: 6. Vieta 7. Datums</p>
<p>Slovenčina (Slovak) ES vyhlásenie o zhode 1. Dolupodpísaný pán *1 zastupujúci výrobcu týmto vyhlasuje, že uvedený strojev je v zhode s nasledovnými smernicami: * Smernica 2006/42/ES (Strojné zariadenia) * Smernica 2014/30/EU na elektromagnetickú kompatibilitu * Smernica 2014/35/EU týkajúca sa elektrického zariadenia určeného na používanie v rámci určitých limitov napätia * Smernica 2014/53/EU o rádiovom zariadení * Rady 2011/65/EU - (EU) 2015/863 o obmedzení používania určitých nebezpečných látok v elektrických a elektronických zariadeniach 2. Popis stroja a) Produkt: Robotická sekačka b) Funkcia : Kosenie trávy c) Model d) Typ e) Výrobné číslo 3. Výrobca a schopný zostaviť technickú dokumentáciu 4. Referencia na použité normy 5. 2014/53/EU: PŘÍLOHA III (Modul B, EU skúška typu) notifikovaný orgán (VDE, 0366) vykonal EU skúška typu a vydal certifikát EU skúšky typu: 6. Miesto 7. Dátu</p>	<p>Eesti (Estonian) EU vastavusdeklaratsioon 1. Allkirjutanud, *1, kinnitab tootja volitatud esindajana, et allpool kirjeldatud masina vastab kõikidele alljärgnevale direktiivide sätetele: * Masinate direktiiv 2006/42/EU * Elektromagnetilise ühilduvuse direktiiv 2014/30/EL * Direktiiv 2014/35/EL teatavates pingevahemikes kasutatavaid elektriseadmeid * Direktiiv 2014/53/EL raadioseadmete * direktiiv 2011/65/EL - (EL) 2015/863 teatavate ohtlike ainete kasutamise piiramise kohta elektri- ja elektroonikaseadmetes 2. Seadmete kirjeldus a) Toode: Robotniiduk b) Funktsioon : muru niitmine c) Mudel d) Tüüp e) Seerianumber 3. Tootja, kes on pädev täita tehnilist dokumentatsiooni 4. Viide kohaldatav standarditele 5. 2014/53/EL: III LISA (Modul B, ELi tüübihindamine) teavitatud asutus (VDE, 0366) teostas ELi tüübihindamine ja andis välja ELi tüübihindamistõendi: 6. Koht 7. Kuupäev</p>	<p>Slovensčina (Slovenian) ES izjava o skladnosti 1. Spodaj podpisani, *1, ki predstavljam proizvajalca, izjavljam da spodaj opisana stroj ustreza vsem navedenim direktivam: * Direktiva 2006/42/ES o strojih * Direktiva 2014/30/EU o elektromagnetni združljivosti * Direktivo 2014/35/EU v zvezi z električno opremo, konstruirano za uporabo znotraj določenih napetostnih * Direktiva 2014/53/EU o radijski opremi * Direktiva 2011/65/EU - (EU) 2015/863 o omejevanju uporabe nekaterih nevarnih snovi v električni in elektronski opremi 2. Opis naprave a) Proizvod: Robotska kosilnica b) Funkcija : košenje trave c) Model d) Tip e) Serijska številka 3. Proizvajalec ki lahko predloži tehnično dokumentacijo 4. Sklici na uporabljene standarde 5. 2014/53/EU: PRILOGA III (Modul B, EU-pregled tipa) je prijavljen organ (VDE, 0366) izvedel EU-pregled tipa in izdal certifikat o EU-pregledu tipa: 6. Kraj 7. Datum</p>
<p>Lietuvių kalba (Lithuanian) EB atitikties deklaracija 1. Žemiau pasirašęs, p. *1 atstovaujantis gamintoją, deklaruoja, kad žemiau aprašyta mašina atitinka visas išvardintų direktyvų nuostatas: * Mechanizmų direktyva 2006/42/EB * Direktiva 2014/30/ES dėl elektromagnetinio suderinamumo * Direktiva 2014/35/ES susijusių su elektrotechniniais gaminiiais, skirtais naudoti tam tikrose įtampos ribose * Direktiva 2014/53/ES dėl radijo ryšio įrenginių * direktyva 2011/65/ES - (ES) 2015/863 dėl tam tikrų pavojingų medžiagų naudojimo elektros ir elektroninėje įrangoje apribojimo 2. Prietaiso aprašymas a) Gaminy: Robotai vejavijovės b) Funkcija : žolės pjovimas c) Modelis d) Tipas e) Serijos numeris 3. Gamintojas ir galintis sudaryti techninę dokumentaciją 4. Nuoroda į taikytus standartus 5. 2014/53/ES: III PRIEDAS (B modulis, ES tipo tyrimas) notifikotoji įstaiga (VDE, 0366) atliko ES tipo tyrimas ir išdavė ES tipo tyrimo sertifikata: 6. Vieta 7. Data</p>	<p>Български (Bulgarian) ЕО декларация за съответствие 1. Допълно подписах с *1, представяващ производител, с настоящото декларирам, че машините, описани по-долу, отговарят на всички съответни разпоредби на: * Директива 2006/42/ЕО относно машините * Директива 2014/30/ЕС за Електромагнитна съвместимост * Директива 2014/35/ЕС във връзка с електрическото оборудване, предназначено за използване при някои ограничения на напрежението * Директива 2014/53/ЕС относно радиосъоръженията * Директива 2011/65/ЕС - (ЕС) 2015/863 година относно ограничението за употребата на определени опасни вещества в електрическото и електронното оборудване 2. Описание на машините a) Продукт: косачка-робот b) Функция : косене на трева c) Модел d) Тип e) Серийен номер 3. Производител и отговорник за съставяне на техническа документация 4. Препратка към приложените стандарти 5. 2014/53/ЕС: ПРИЛОЖЕНИЕ III (Модул В, ЕС изследване на типа) нофицираният орган (VDE, 0366) извърши ЕС изследване на типа и издаде сертификата за ЕС изследване на типа: 6. Място на изготвяне 7. Дата на изготвяне</p>	<p>Norsk (Norwegian) EF- Samsvarserklæring 1. Undertegnede, *1 representerer produsenten og herved erklærer at maskinene beskrevet nedenfor innfrir relevant informasjon fra følgende forskrifter. * Maskindirektivet 2006/42/EF * Direktiv 2014/30/EU om Elektromagnetisk kapabilitet * Direktiv 2014/35/EU relatert til elektrisk utstyr laget for bruk innenfor visse spenningsgrenser. * Direktiv 2014/53/EU om radio utstyr * Direktiv 2011/65/EU - (EU) 2015/863 om restriksjoner av bruk av visse farlige materialer i elektrisk og elektronisk utstyr. 2. Beskrivelse av produkt a) Produkt: Robot gressklipper b) Funksjon : Klippe gress c) Modell d) Type e) Serienummer 3. Produsent og i stand til å utarbeide den tekniske dokumentasjonen 4. Henvisning til brukte standarder 5. 2014/53/EU: Vedlegg III (modul B, EU-type undersøkelser) Det tekniske kontrollorgan (VDE, 0366) utførte EU-typeprøving og utstedte EU-typeprøvingssertifikatet: 6. Sted 7. Dato</p>
<p>Türk (Turkish) AT Uygunluk Beyanı 1. Aşağıda imzası bulunan *1, üreticinin adına, bu yazıyla birlikte aşağıdaki makine ile ilgili tüm hükümlülüklerin yerine getirildiğini beyan etmektedir: * Makina Emniyet Yönetmeliği 2006/42/AT * Elektromanyetik uyumlulukla ilgili 2014/30/AB no' lu yönetmelik * 2014/35/AB belirli voltaj aralıklarında kullanılmak üzere dizayn edilmiş ekipmanlar hakkındaki yönetmelik * Radyo Ekipmanlarının 2014/53/AB sayılı direktif * 2011/65/AB - (AB) 2015/863 elektrikli ve elektronik ekipmanlarda bazı tehlikeli maddelerin kullanımını yasaklanmasını ilişkin yönetmelik 2. Makinanın tanımı a) Ürün: Robotik çim biçme makinası b) İşlevi : Çimlerin kesilmesi c) Model d) Tipi e) Seri numarası 3. Teknik dosyayı hazırlamakla yetkili olan Toplulukta yerleşik İmalatçı 4. Uygulanan standartlara istinaden 5. 2014/53/EU: Ek III (Modül B, AVRUPA(EU)-tip inceleme Onaylanan kuruluş (VDE, 0366), AVRUPA(EU)-tip inceleme uyguladı ve AVRUPA(EU) tip inceleme sertifikasını yayınladı: 6. Beyanın yeri : 7. Beyanın tarihi :</p>	<p>Íslenska (Icelandic) EB-Samræmisýfirlýsing 1. Undirritaður, *1, fyrir hönd framleiðandans, lýsir hér með yfir því að vélin sem lýst er hér að neðan samræmist öllum gildandi ákvæðum tilskipunar: *Leiðbeiningar fyrir vélbúnað 2006/42/EB *TILSKIPUN 2014/30/EU VARÐANDI SAMHÆFNI RAFSEGULSVÍÐS *TILSKIPUN 2014/35/EU varðandi rafknúin tækni sem notast innan tiltekns volta ramma og * Tilskipun 2014/53/EU um útværptækni * Tilskipun 2011/65/EU - (EU) 2015/863 varðandi leiðbeiningar um notkun á hættulegum efnum í raf og rafeinda búnaði 2. Lýsing á vélbúnaði a) Ökutæki: Sjálfstýrt sláttuvél b) Virkni : Gras stegið c) Gerð d) Tegund e) Seríal númer 3. Framleiðandi og fær um að taka saman tækniskjölín 4. Tilvísun til viðeigandi staðla 5. ESB reglugerð 2014/53: vauðaki 111 (module B, ESB gerðarprófun) Tilkynnt gerð (VDE,0366) hefur staðist ESB gerðarpróf og fengið EB gerðarprófunar vottorð: 6. Gert hjá 7. Dagsetning</p>	<p>Hrvatski (Croatian) EK Izjava o skladnosti 1. Potpisani, *1, u ime proizvođača, ovime izjavljuju da strojevi navedeni u nastavku ispunjavaju sve važeće odredbe: * Propisa za strojeve 2006/42/EK * Propisa 2014/30/EU na elektromagnetsku kompatibilnost * Direktiva 2014/35/EU se odnosi na električnu opremu predviđenu za korištenje unutar određenih naponskih granica. * Direktiva 2014/53/EU o radijskoj opremi * Direktiva 2011/65/EU - (EU) 2015/863 o ograničenju određenih opasnih supstanci u električnoj i elektronskoj opremi. 2. Opis strojeva a) Proizvod: Robot kosilica za travu b) Funkcionalnost : rezanje trave c) Model d) Tip e) Serijski broj 3. Proizvođač i osoba za sastavljanje tehničke dokumentacije 4. Referencija na primijenjene standarde 5. 2014/53/EU: PRILOG III. (Modul B, EU ispitivanje tipa) prijavljeno tijelo (VDE, 0366) provelo je EU ispitivanje tipa i izdalo potvrdu o EU ispitivanju tipa: 6. U 7. Datum</p>

LCD MENU INDEX

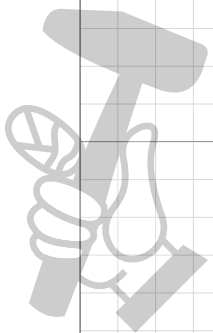
Menu name	Step	Page
A Advanced setting	Garden setup → Mowing setup	P.57
Alarm	System settings → Security	P.76
Auto mode	Garden setup → Mowing setup → Mowing pattern → Auto mode	P.56
B BG color	System settings → Display/Sound	P.75
C Capacity for homing	Garden setup → Homing setup	P.66
Check signal	Diagnostics	P.68
Contrast	System settings → Display/Sound	P.74
Create a PIN	System settings → Security	P.76
D Date and time	System settings	P.75
Docking direction	Garden setup → Garden layout	P.63
E Edge cutting	Garden setup → Mowing setup → Advanced setting	P.58
F Factory reset	System settings → Reset	P.78
Fault history	History	P.73
Free zone	Garden setup → Mowing setup → GNSS	P.61
G Garden layout	Garden setup	P.63
Garden size	Garden setup → Mowing setup	P.64
GNSS	Garden setup → Mowing setup	P.61
H Help	Press and hold number button “0”	P.78
Homing setup	Garden setup	P.65
K Keypad	System settings → Display/Sound	P.75
L Language	System settings	P.74
M Manual mode	Garden setup → Mowing setup → Mowing pattern	P.90
Mowing pattern	Garden setup → Mowing setup	P.56
Mowing setup	Garden setup	P.52
O Operating time	History → Operating history	P.71
Operation history	History	P.71
P Passage width	Garden setup → Homing setup	P.65
Q Quiet timer	Work timer	P.51
R Reset	System settings	P.78
S Satellite assisted homing	Garden setup → Homing setup	P.67
Seasonal timer	Work timer	P.49
Security	System settings	P.76
Setup wizard	Setup wizard	P.31
Short cut wire	Garden setup → Garden layout	P.64
Signal type	Garden setup → Garden layout	P.64
Spiral cutting	Garden setup → Mowing setup → Advanced setting	P.60
Start points	Garden setup → Mowing setup	P.55
Start points	Work timer	P.47
T TCU	System settings → Security	P.77
Test return home	Garden setup → Homing setup	P.67
Test start points	Diagnostics → Test start points	P.69
W Wire length	Garden setup → Garden layout	P.64
Wire overlap	Garden setup → Mowing setup → Advanced setting	P.57
Work history	History → Operating history	P.72
Work timer	Work timer	P.46

LAWN DIAGRAM

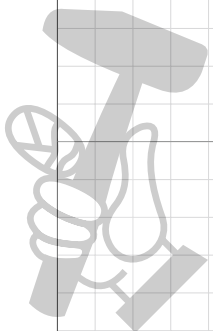




МАГАЗИН
БАЩ МАЙСТОРА[®]
ПРОФЕСИОНАЛНИ РЕШЕНИЯ



МАГАЗИН
БАЩ МАЙСТОРА[®]
ПРОФЕСИОНАЛНИ РЕШЕНИЯ



МАГАЗИН
БАШ МАЙСТОРА[®]
ПРОФЕСИОНАЛНИ РЕШЕНИЯ

DEALER CHECKSHEET

The following information is provided by your dealer after setup is complete.
You can save your settings using Mii-monitor and restore them in case you made unwanted modifications. You can also restore your dealer's recommended settings from Mii-monitor to your lawnmower.

Basic setting information (pages 30, 74, 76)

PIN (Personal Identification Number):

--	--	--	--

Language : English / Deutsch / Français / Italiano / Nederlands / Svenska / Norsk / Español / Polski / Dansk / Suomalainen / Čeština

Setup wizard setting information (page 31)

The following items are related to the basic settings for Setup wizard.

Garden layout (page 31)

Docking direction: 1 / 2 / 3 / 4

Wire length: _____ m

Garden size: _____ m²

Signal type: A / B / C / D

Shortcut Wire 0 / 1

Start point (page 34)

Starting points	Direction	From station to start point	Area percentage
Point 1	S1/ CW / ACW	m	%
Point 2	S1/ CW / ACW	m	%
Point 3	S1/ CW / ACW	m	%
Point 4	S1/ CW / ACW	m	%
Point 5	S1/ CW / ACW	m	%

Work timer (page 37)

Day of the week	Timer 1	Timer 2	Starting point
Monday	__ : __ - __ : __	__ : __ - __ : __	1 / 2 / 3 / 4 / 5
Tuesday	__ : __ - __ : __	__ : __ - __ : __	1 / 2 / 3 / 4 / 5
Wednesday	__ : __ - __ : __	__ : __ - __ : __	1 / 2 / 3 / 4 / 5
Thursday	__ : __ - __ : __	__ : __ - __ : __	1 / 2 / 3 / 4 / 5
Friday	__ : __ - __ : __	__ : __ - __ : __	1 / 2 / 3 / 4 / 5
Saturday	__ : __ - __ : __	__ : __ - __ : __	1 / 2 / 3 / 4 / 5
Sunday	__ : __ - __ : __	__ : __ - __ : __	1 / 2 / 3 / 4 / 5

Seasonal timer: Manual / Deactivate (page 39, 49)

Region: North / North Central / South Central / South


Percentage: JAN : _____ % FEB : _____ % MAR : _____ % APR : _____ %
MAY : _____ % JUN : _____ % JUL : _____ % AUG : _____ %
SEP : _____ % OCT : _____ % NOV : _____ % DEC : _____ %

Other setting item information

Please fill the following items if configuring them with the Menu settings.

Garden layout setting information (pages 55, 63, 65)

Passage width:

 Home screen → [2.Garden setup] → [1.Mowing setup] → [1.Start points] → [1.Point 1] to [5.Point 5]

Point 1: ____ - ____ Point 2: ____ - ____ Point 3: ____ - ____

Point 4: ____ - ____ Point 5: ____ - ____

Passage width (Homing):


 Home screen → [2.Garden setup] → [4.Homing setup] → [1.Passage width]

MIN: ____ MAX: ____

Useful features information (pages 51, 58, 60)

 Home screen → [1.Work timer] → [4.Quiet timer]

Quiet timer: ON / OFF From __ : __ to __ : __

 Home screen → [2.Garden setup] → [1.Mowing setup] → [3.Advanced setting]

Edge cutting: ON / OFF

Spiral cutting: ON / OFF

Dealer setting back up:

With Dr.H or Mii-monitor: YES / NO

*The following screen is for dealers only.

 Home screen → [5.System settings] → [6.Dealer setting]

On Lawnmower Display: YES / NO

Your dealer's contact information is below:

Dealer:

Tel:

Mail:

Your Mii-monitor personal id:

QUICK GUIDE

Fundamentals

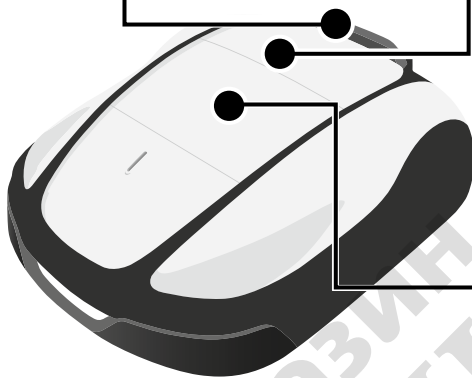
For the HRM1000, refer to the Mii-monitor Operation Guide.

Turning on / off the power
(☞ page 13, 87)

Sending back home
(☞ page 13)

Mii-monitor
Refer to the Mii-monitor Operation Guide.

Stopping the lawnmower
(☞ page 11)



Adjusting the cutting height (☞ page 93)

Decrease Increase

Blade height

Daily use

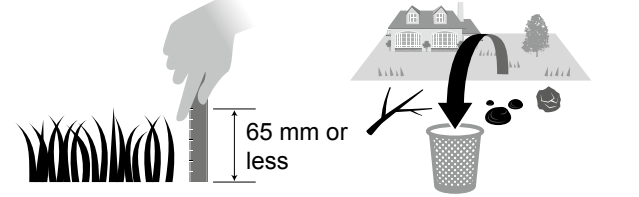
1 Menu settings

2 Check the garden



Configure the operation mode, timer, and other settings.

- Work settings for the garden
 - Mowing start point settings (☞ page 47)
 - Mowing pattern settings (☞ page 56)
- Timer settings (☞ page 46)
- Useful settings (☞ page 49, 51, 56)
- Operation checks (☞ page 68)
- Setup wizard (☞ page 29)
- Mii-monitor (☞ page 79)



Maintain the area before the lawnmower starts mowing.

- Checking the garden (☞ page 84)
- Removing foreign objects from the area (☞ page 84)

Technical tips

Mowing mode

You can select from 2 modes of operation (available in “Menu Settings”).

- **Auto mode** (☞ page 89)

The lawnmower automatically mows according to inputted time and garden settings.

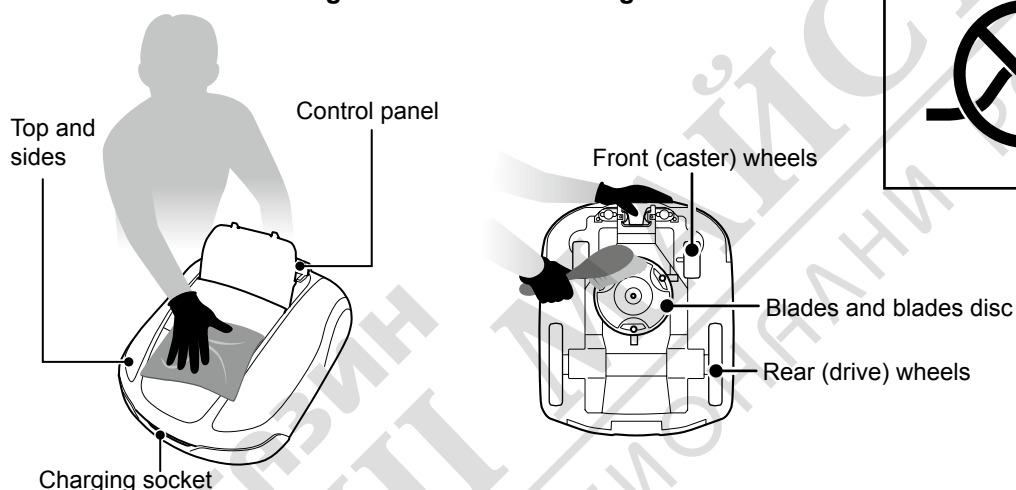
- **Manual mode** (☞ page 90)

Start mowing anytime without timer settings.

Cleaning the lawnmower (☞ page 104)

Clean dirt and grass off of the lawnmower using a brush and cloth.

Remove dirt and grass from the following areas:

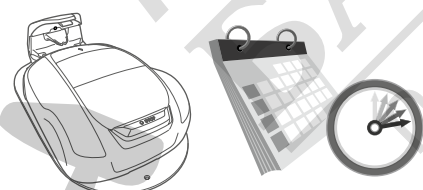


NOTE:

- Do not clean the lawnmower with solvent, a high-pressure cleaner, a garden hose, etc.



3 Paused



Put on “Paused” state for work so you can start operation at your desired time.

- Adjusting the height of the blades (☞ page 93)
- Checking the “Paused” state (☞ page 87)
- Checking the docking station connections (☞ page 84)

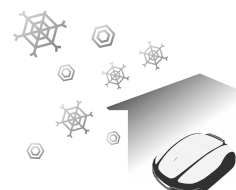
4 Weekly check



Regularly check the lawnmower for assurance.

- Checking the standby status (☞ page 86)
- Checking the docking station connections (☞ page 106)
- Blade conditions (☞ page 113)
- Checking the parts (☞ page 102, 105)

5 Storage

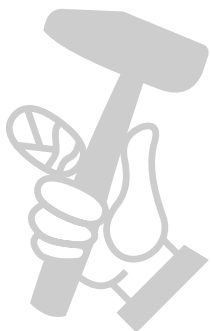


Store properly for next use.

- Cleaning and replacing the blades (☞ page 113)
- Cleaning the lawnmower (☞ page 104)
- Cleaning the docking station (☞ page 105)
- Disconnecting the power cord (☞ page 84)

HONDA

МАГАЗИН
БАШ МАЙСТОРА[®]
ПРОФЕСИОНАЛНИ РЕШЕНИЯ



32VP7700
00X32-VP7-7000

© Honda Motor Co., Ltd. 2023

1000/1500/1500 Live/
2500/2500 Live
xxxx.xxxx.xx
Printed in France