

**Einhell**<sup>®</sup>

**GC-DP 6315 N**<sup>®</sup>

- 
- D** Originalbetriebsanleitung  
Schmutzwasserpumpe
- GB** Original operating instructions  
Dirty Water Pump
- F** Mode d'emploi d'origine  
Pompe eaux usées
- I** Istruzioni per l'uso originali  
Pompa per acque reflue
- S** Original-bruksanvisning  
Smutsvattenpump
- HR/** Originalne upute za uporabu  
**BIH** Pumpa za prljavu vodu
- RS** Originalna uputstva za upotrebu  
Pumpa za prljavu vodu



**Art.-Nr.: 41.704.91**

**I.-Nr.: 11026**

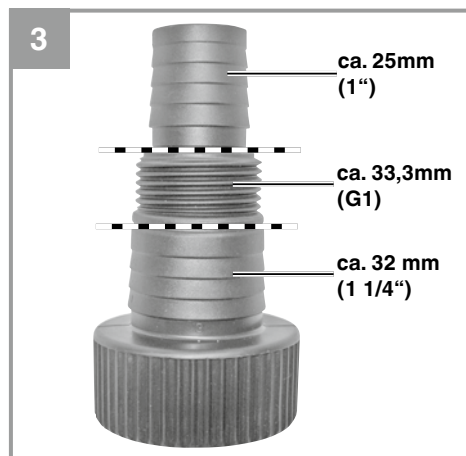

**Table of contents**

1. Safety regulations
2. Layout and items supplied
3. Proper use
4. Technical data
5. Before starting the equipment
6. Operation
7. Replacing the power cable
8. Cleaning, maintenance and ordering of spare parts
9. Disposal and recycling
10. Storage
11. Troubleshooting guide

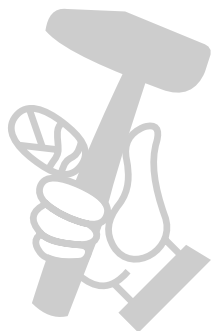

МАГАЗИН МАЙСТОРА®  
БАШ МАЙСТОРА  
ПРОФЕСИОНАЛНИ РЕШЕНИЯ



**Caution** - Read the operating instructions to reduce the risk of injury

МАГАЗИН  
БАШ МАЙСТОРА®  
ПРОФЕСИОНАЛНИ РЕШЕНИЯ

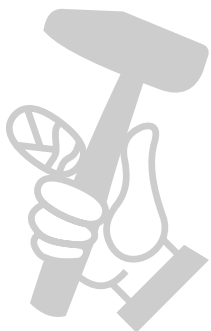

**⚠ Important!**

When using the equipment, a few safety precautions must be observed to avoid injuries and damage. Please read the complete operating instructions and safety regulations with due care. Keep this manual in a safe place, so that the information is available at all times. If you give the equipment to any other person, hand over these operating instructions and safety regulations as well. We cannot accept any liability for damage or accidents which arise due to a failure to follow these instructions and the safety instructions.

**1. Safety regulations****⚠ Caution!**

**Read all safety regulations and instructions.**

Any errors made in following the safety regulations and instructions may result in an electric shock, fire and/or serious injury.

**Keep all safety regulations and instructions in a safe place for future use.**

**⚠ Caution!**

**The pump must be powered via an earth-leakage circuit breaker (RCD) with a rated fault current of no more than 30 mA (according to VDE 0100 Part 702 and 738).**

**The equipment is not designed for use in swimming pools and paddling pools of any kind or other bodies of water in which people or animals may be present during operation. It is prohibited to operate the equipment if a person or animal is in the danger area. Ask your electrician!**

This equipment can be used by children of 8 years and older and by people with limited physical, sensory or mental capacities or those with no experience and knowledge if they are supervised or have received instruction in how to use the equipment safely and understand the dangers which result from such use.

Children are not allowed to play with the equipment. Unless supervised, children are not allowed to clean the equipment and carry out user-level maintenance work.

**Important!**

- Before you put the equipment into operation, arrange for a specialist to check that the
  - earthing
  - protective multiple earthing
  - residual-current operated circuit-breaker circuit
 comply with the safety regulations of the power supply company and work correctly.
- The electrical plug-in connections must be protected from wet conditions.
- If there is a risk of flooding, place the plug-in connections in an area which is safe from flooding.
- Strictly avoid pumping aggressive liquids and abrasive substances.
- Protect the equipment from frost.
- Protect the equipment from dry running.
- Take suitable measures to keep the equipment out of the reach of children.
- There is a risk of the liquid becoming contaminated by escaping lubricant.

**2. Layout and items supplied****2.1 Layout (Fig. 1)**

1. Handle
2. Universal hose connection
3. Intake cage
4. Floating switch

**2.2 Items supplied**

Please check that the article is complete as specified in the scope of delivery. If parts are missing, please contact our service center or the nearest branch of the DIY store where you made your purchase at the latest within 5 work days after purchasing the article and upon presentation of a valid bill of purchase. Also, refer to the warranty table in the warranty provisions at the end of the operating instructions.

- Open the packaging and take out the equipment with care.

- Remove the packaging material and any packaging and/or transportation braces (if available).
- Check to see if all items are supplied.
- Inspect the equipment and accessories for transport damage.
- If possible, please keep the packaging until the end of the guarantee period.

#### Important!

**The equipment and packaging material are not toys. Do not let children play with plastic bags, foils or small parts. There is a danger of swallowing or suffocating!**

- Dirty water pump
- Original operating instructions
- Safety instructions

### 3. Proper use

The equipment you have purchased is designed to pump water with a maximum temperature of 35 °C. This equipment must never be used for other liquids, especially engine fuels, cleaning agents and other chemically-based products! Before you use the pump, clarify any possible special conditions which need to be fulfilled for the installation! For example, additional safety measures may be needed if damage to property could result from a power failure, soiling or a defective gasket.

Examples of such safety measures: Pumps running in parallel on a separately protected power circuit, moisture sensors for switching off the pumps, and similar safety arrangements.

Be sure to consult a professional plumber if you have any doubt.

The equipment can be used wherever you want to move water, e.g. in the house, in the garden, and for many other applications. It must not be used to operate swimming pools!

If you want to use the equipment in bodies of water with a natural, muddy bottom, place the equipment in a slightly elevated position, e.g. on bricks.

The equipment is not designed for continuous operation, e.g. as a circulating pump in a pond. In this case the equipment's anticipated life will be greatly shortened because the equipment was not designed for continuous loading.

The equipment is to be used only for its prescribed purpose. Any other use is deemed to be a case of misuse. The user / operator and not the manufacturer will be liable for any damage or injuries of any kind caused as a result of this.

Please note that our equipment has not been designed for use in commercial, trade or industrial applications. Our warranty will be voided if the machine is used in commercial, trade or industrial businesses or for equivalent purposes.

### 4. Technical data

Mains connection .....	230V ~ 50 Hz
Power rating .....	630 W
Max. pumping rate .....	17,000 l/h
Max. delivery head .....	8 m
Max. immersion depth .....	5 m
Max. water temperature .....	35 °C
Hose connection .....	ca. 47, 8 mm (G1 1/2)IG
Max. size of foreign bodies: .....	Ø 15 mm
Switching point height: ON .....	max. approx. 50 cm
Switching point height: OFF .....	min. approx. 5 cm
Protection type .....	IPX8

### 5. Before starting the equipment

#### 5.1 Installation

The equipment can be installed either:

- Stationary with rigid tubing or
- Stationary with a flexible hose line

#### Note:

The maximum pumping rate is possible only with the largest possible line diameter; if smaller hoses or tubes are connected, the pumping rate will be reduced. If the universal hose connection (Fig. 1/ Item 2) is used, it should be shortened (as shown in Fig. 3) to the connection actually used in order not to reduce the pumping rate unnecessarily. Flexible hoses must be fastened to the universal hose connection with a hose clip (not included in the scope of supply).

#### Note!

When installing, never hang the equipment by the discharge line or by the power cable. The equipment must be hung up with the provided carry handle or it must rest on the bottom of the shaft.

To ensure that the equipment works properly, the bottom of the shaft always must be free of sludge and other accumulations of dirt. If the water level is too low, the sludge in the shaft can quickly dry out and hinder the equipment from starting. It is necessary therefore to check the equipment regularly (carry out trial start-ups).

**Note:**

The pump shaft should measure at least 50 x 50 x 50 cm so that the floating switch can move freely.

**5.2 Mains connection**

The equipment you have purchased comes with an earthing-pin plug. The equipment is designed for connection to a socket outlet with earthing contact for 230 V ~ 50 Hz. Make sure that the socket-outlet is sufficiently fused (at least 6 A) and in good working order. Insert the power plug in the socket-outlet and the equipment is ready for operation.

**Important!**

To rule out danger, this work must be left strictly to a specialist electrician or Customer Service.

**6. Operation**

You can put the equipment into operation after you have thoroughly read the installation and operating instructions. Pay attention to the following points:

- Make sure that the equipment is set up securely.
- Check that the discharge line is fitted correctly.
- Make sure that the electrical connection is 230 V ~ 50 Hz.
- Check that the electrical socket-outlet is in good working order.
- Make sure that no moisture or water can ever reach the power connection.
- Make sure that the equipment does not run dry.

**Setting the ON/OFF switching point:**

The ON/OFF switching point of the floating switch can be adjusted by shifting the floating switch in the floating switch notched holder (Fig. 2/item 5). Check the following points before putting the equipment into operation:

- The floating switch must be fitted so that the

switching point height: ON and the switch point height: OFF can be reached easily and with little force. Check this by placing the equipment in a container filled with water and carefully raising and lowering the floating switch with your hand. You can then see whether the equipment switches on and off.

- Make sure that the distance between the floating switch head and the cable holder is not too small. If the distance is too small, there is no guarantee that the equipment will work correctly.
- When adjusting the floating switch, make sure that the floating switch does not touch the bottom before the equipment is switched off. Important! Risk of dry running.

**Manual operation:**

Mount the floating switch as illustrated in Figure 1. The equipment will then run continuously. To prevent dry running, this operating mode is allowed only under supervision. The equipment must be switched off (pull out the power plug) as soon as no more water is emitted from the discharge line.

**7. Replacing the power cable**

If the power cable for this equipment is damaged, it must be replaced by the manufacturer or its after-sales service or similarly trained personnel to avoid danger.

**8. Cleaning, maintenance and ordering of spare parts**

Unplug the power plug prior to any maintenance work.

**8.1 Cleaning**

- For mobile applications, the equipment should be cleaned with clear water after every usage.
- For stationary installation, it is recommended that you check the floating switch for proper functioning every three months.
- Use a water jet to remove any lint or fibrous particles that may have become trapped in the housing.
- Remove sludge from the shaft bottom and clean the shaft walls every 3 months.
- Use clear water to remove deposits from the floating switch.

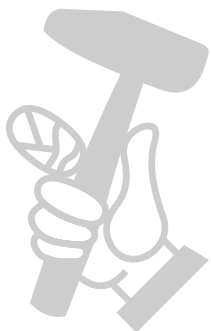

## 8.2 Maintenance

There are no parts inside the equipment which require additional maintenance.

## 8.3 Ordering replacement parts:

Please quote the following data when ordering replacement parts:

- Type of machine
- Article number of the machine
- Identification number of the machine
- Replacement part number of the part required

For our latest prices and information please go to [www.isc-gmbh.info](http://www.isc-gmbh.info)

## 9. Disposal and recycling

The equipment is supplied in packaging to prevent it from being damaged in transit. The raw materials in this packaging can be reused or recycled. The equipment and its accessories are made of various types of material, such as metal and plastic. Never place defective equipment in your household refuse. The equipment should be taken to a suitable collection center for proper disposal. If you do not know the whereabouts of such a collection point, you should ask in your local council offices.

## 10. Storage

Store the equipment and accessories out of children's reach in a dark and dry place at above freezing temperature. The ideal storage temperature is between 5 and 30 °C. Store the electric tool in its original packaging.

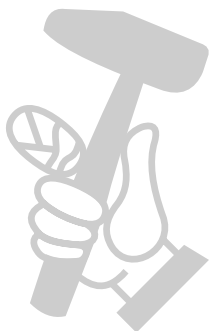

## 11. Troubleshooting guide

Faults	Cause	Remedy
The equipment does not start	<ul style="list-style-type: none"> <li>- Power supply not connected</li> <li>- Floating switch does trigger</li> </ul>	<ul style="list-style-type: none"> <li>- Check power supply</li> <li>- Raise position of floating switch</li> </ul>
The equipment does not pump	<ul style="list-style-type: none"> <li>- Intake sieve clogged</li> <li>- Discharge hose kinked</li> </ul>	<ul style="list-style-type: none"> <li>- Clean intake sieve with water jet</li> <li>- Unkink the hose</li> </ul>
The equipment does not cut out	<ul style="list-style-type: none"> <li>- Floating switch cannot sink</li> </ul>	<ul style="list-style-type: none"> <li>- Place equipment correctly on shaft bottom</li> </ul>
Insufficient pumping rate	<ul style="list-style-type: none"> <li>- Intake sieve clogged</li> <li>- Performance reduced due to heavily contaminated and abrasive water impurities</li> </ul>	<ul style="list-style-type: none"> <li>- Clean intake sieve</li> <li>- Clean equipment and replace wear parts</li> </ul>
The equipment switches off after briefly running	<ul style="list-style-type: none"> <li>- Motor circuit-breaker switches the equipment off due to excessive water contamination</li> <li>- Water temperature too high; motor circuit-breaker switches the equipment off</li> </ul>	<ul style="list-style-type: none"> <li>- Unplug power plug and clean equipment and shaft</li> <li>- Ensure that maximum permissible water temperature (35 °C) is not exceeded</li> </ul>

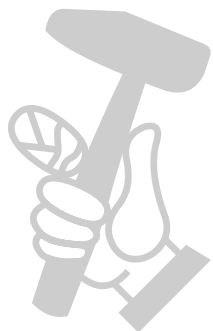



For EU countries only

Never place any electric power tools in your household refuse.

To comply with European Directive 2012/19/EU concerning old electric and electronic equipment and its implementation in national laws, old electric power tools have to be separated from other waste and disposed of in an environment-friendly fashion, e.g. by taking to a recycling depot.

Recycling alternative to the return request:

As an alternative to returning the equipment to the manufacturer, the owner of the electrical equipment must make sure that the equipment is properly disposed of if he no longer wants to keep the equipment. The old equipment can be returned to a suitable collection point that will dispose of the equipment in accordance with the national recycling and waste disposal regulations. This does not apply to any accessories or aids without electrical components supplied with the old equipment.

The reprinting or reproduction by any other means, in whole or in part, of documentation and papers accompanying products is permitted only with the express consent of the iSC GmbH.

Subject to technical changes

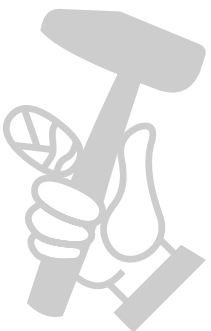

## Service information

We have competent service partners in all countries named on the guarantee certificate whose contact details can also be found on the guarantee certificate. These partners will help you with all service requests such as repairs, spare and wearing part orders or the purchase of consumables.

Please note that the following parts of this product are subject to normal or natural wear and that the following parts are therefore also required for use as consumables.

Category	Example
Wear parts*	Impeller
Consumables*	
Missing parts	

\* Not necessarily included in the scope of delivery!

In the effect of defects or faults, please register the problem on the internet at [www.isc-gmbh.info](http://www.isc-gmbh.info). Please ensure that you provide a precise description of the problem and answer the following questions in all cases:

- Did the equipment work at all or was it defective from the beginning?
- Did you notice anything (symptom or defect) prior to the failure?
- What malfunction does the equipment have in your opinion (main symptom)?  
Describe this malfunction.

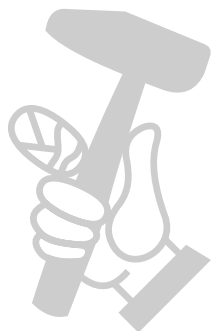

## Warranty certificate

Dear Customer,

All of our products undergo strict quality checks to ensure that they reach you in perfect condition. In the unlikely event that your device develops a fault, please contact our service department at the address shown on this guarantee card. You can also contact us by telephone using the service number shown. Please note the following terms under which guarantee claims can be made:

1. These guarantee terms apply to consumers only, i.e. natural persons intending to use this product neither for their commercial activities nor for any other self-employed activities. These warranty terms regulate additional warranty services, which the manufacturer mentioned below promises to buyers of its new products in addition to their statutory rights of guarantee. Your statutory guarantee claims are not affected by this guarantee. Our guarantee is free of charge to you.
2. The warranty services cover only defects due to material or manufacturing faults on a product which you have bought from the manufacturer mentioned below and are limited to either the rectification of said defects on the product or the replacement of the product, whichever we prefer.  
Please note that our devices are not designed for use in commercial, trade or professional applications. A guarantee contract will not be created if the device has been used by commercial, trade or industrial business or has been exposed to similar stresses during the guarantee period.
3. The following are not covered by our guarantee:
  - Damage to the device caused by a failure to follow the assembly instructions or due to incorrect installation, a failure to follow the operating instructions (for example connecting it to an incorrect mains voltage or current type) or a failure to follow the maintenance and safety instructions or by exposing the device to abnormal environmental conditions or by lack of care and maintenance.
  - Damage to the device caused by abuse or incorrect use (for example overloading the device or the use of unapproved tools or accessories), ingress of foreign bodies into the device (such as sand, stones or dust, transport damage), the use of force or damage caused by external forces (for example by dropping it).
  - Damage to the device or parts of the device caused by normal or natural wear or tear or by normal use of the device.
4. The guarantee is valid for a period of 24 months starting from the purchase date of the device. Guarantee claims should be submitted before the end of the guarantee period within two weeks of the defect being noticed. No guarantee claims will be accepted after the end of the guarantee period. The original guarantee period remains applicable to the device even if repairs are carried out or parts are replaced. In such cases, the work performed or parts fitted will not result in an extension of the guarantee period, and no new guarantee will become active for the work performed or parts fitted. This also applies if an on-site service is used.
5. To make a claim under the guarantee, please register the defective device at: [www.isc-gmbh.info](http://www.isc-gmbh.info). Please keep your bill of purchase or other proof of purchase for the new device. Devices that are returned without proof of purchase or without a rating plate shall not be covered by the guarantee, because appropriate identification will not be possible. If the defect is covered by our guarantee, then the item in question will either be repaired immediately and returned to you or we will send you a new replacement.

Of course, we are also happy offer a chargeable repair service for any defects which are not covered by the scope of this guarantee or for units which are no longer covered. To take advantage of this service, please send the device to our service address.

Also refer to the restrictions of this warranty concerning wear parts, consumables and missing parts as set out in the service information in these operating instructions.

