

Einhell

TC-GG 30

D	Originalbetriebsanleitung Heißklebepistole	NL	Originele handleiding Lijmpistool
GB	Original operating instructions Hot Glue Gun	E	Manual de instrucciones original Pistola de termopegado
F	Instructions d'origine Pistolet à thermocollage	FIN	Alkuperäiskäyttöohje Kuumaliimapistooli
I	Istruzioni per l'uso originali Pistola per colla a caldo	RUS	Оригинальное руководство по эксплуатации Пистолет горячей склейки
S	Original-bruksanvisning Limpistol	SLO	Originalna navodila za uporabo Pištola za vroče lepljenje
CZ	Originální návod k obsluze Tavná pistole	H	Eredeti használati utasítás Forróragasztópisztoly
SK	Originálny návod na obsluhu Teplná lepiaca pištoľ	GR	Πρωτότυπος Οδηγίες χρήσης Πιστόλι θερμής συγκόλλησης



Art.-Nr.: 45.221.70



I.-Nr.: 11016

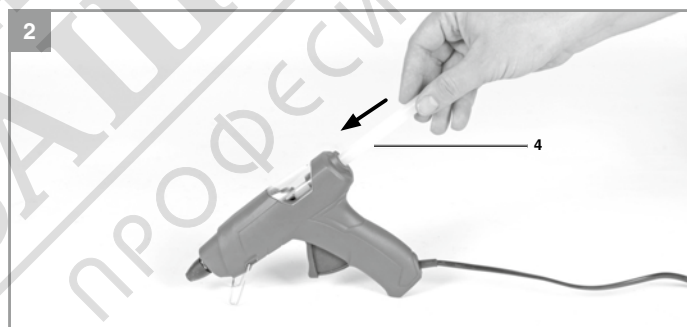

-2-

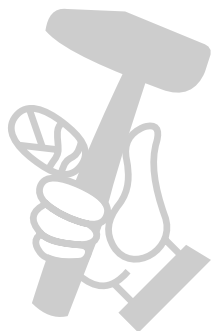

МАГАЗИН МАЙСТОР®
ПРОФЕССИОНАЛЬНЫЕ РЕШЕНИЯ

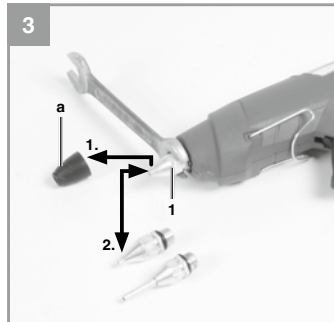

МАГАЗИН МАЙСТОРА®
БАШ МАЙСТОРА
ПРОФЕСІОНАЛНИ РЕШЕНИЯ

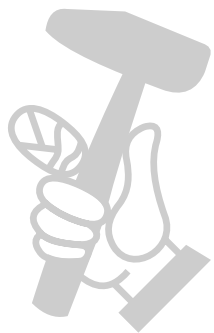

GB



Danger! - Read the operating instructions to reduce the risk of injury



Caution! Wear safety goggles. Sparks generated during working or splinters, chips and dust emitted by the device can cause loss of sight.



Safety class II

МАГАЗИН МАЙСТОРА®
БАШ ПРОФЕСИОНАЛНИ РЕШЕНИЯ

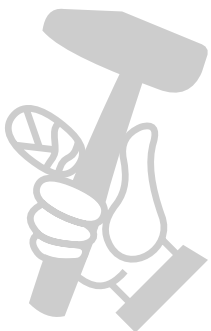

Danger!

When using the equipment, a few safety precautions must be observed to avoid injuries and damage. Please read the complete operating instructions and safety regulations with due care. Keep this manual in a safe place, so that the information is available at all times. If you give the equipment to any other person, hand over these operating instructions and safety regulations as well. We cannot accept any liability for damage or accidents which arise due to a failure to follow these instructions and the safety instructions.

1. Safety regulations

The corresponding safety information can be found in the enclosed booklet.

Danger!**Read all safety regulations and instructions.**

Any errors made in following the safety regulations and instructions may result in an electric shock, fire and/or serious injury.

Keep all safety regulations and instructions in a safe place for future use.

2. Layout and items supplied**2.1 Layout (Fig. 1)**

- 1 Nozzle
- 2 Support stand
- 3 Trigger lever
- 4 Glue stick

2.2 Items supplied

Please check that the article is complete as specified in the scope of delivery. If parts are missing, please contact our service center or the sales outlet where you made your purchase at the latest within 5 working days after purchasing the product and upon presentation of a valid bill of purchase. Also, refer to the warranty table in the service information at the end of the operating instructions.

- Open the packaging and take out the equipment with care.
- Remove the packaging material and any packaging and/or transportation braces (if available).
- Check to see if all items are supplied.
- Inspect the equipment and accessories for transport damage.

- If possible, please keep the packaging until the end of the guarantee period.

Danger!

The equipment and packaging material are not toys. Do not let children play with plastic bags, foils or small parts. There is a danger of swallowing or suffocating!

- Hot glue gun
- Original operating instructions
- Safety instructions

3. Proper use

You can use the hot glue gun to glue the following materials: Wood, plastics, textiles, cardboard, ceramics, leather, etc.

The equipment is to be used only for its prescribed purpose. Any other use is deemed to be a case of misuse. The user / operator and not the manufacturer will be liable for any damage or injuries of any kind caused as a result of this.

Please note that our equipment has not been designed for use in commercial, trade or industrial applications. Our warranty will be voided if the machine is used in commercial, trade or industrial businesses or for equivalent purposes.

4. Technical data

Mains voltage: 220-240 V ~ 50 Hz
 Power consumption: 30 (200 W)
 Warm-up time approx. 5 minutes
 Melting temperature max. 252°C
 Operating temperature approx. 195°C
 Glue stick diameter 11 mm
 Protection class: II/□
 Weight: 0.3 kg

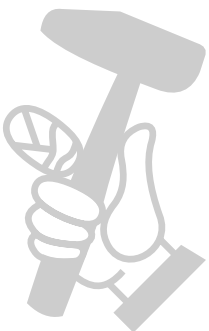

5. Before starting the equipment

Before you connect the equipment to the mains supply make sure that the data on the rating plate are identical to the mains data.

Warning!
Always pull the power plug before making adjustments to the equipment.

Only place the hot glue gun on non-flammable surfaces.

Push the glue stick into the hot glue gun as far as the stop. Now plug the mains plug into the mains socket outlet. The hot glue gun is ready for use after a heating time of approx. 5 minutes.

6. Operation

You can now apply the glue by pressing the trigger. Press both surfaces together immediately and apply pressure. It takes about 30 seconds for the glue to set.

Warning!
If your gluing work is interrupted or completed, always be sure to place the hot glue gun on the support stand.

Important! Glue stains on textiles cannot be removed.

Changing the nozzles (Fig. 3)

You can change the nozzles (1) to work better in certain positions. Proceed as follows:

- Pull the rubber cap (a) off the nozzle (1)
- Remove the nozzle using a 13 mm wrench (not included)
- Check the seal (rubber ring) on the new nozzle for damage
- Fit the new nozzle to the device and tighten it
- Fit the rubber cap back onto the nozzle

7. Replacing the power cable

Danger!
If the power cable for this equipment is damaged, it must be replaced by the manufacturer or its after-sales service or similarly trained personnel to avoid danger.

8. Cleaning, maintenance and ordering of spare parts

Danger!
Always pull out the mains power plug before starting any cleaning work.

8.1 Cleaning

- Keep all safety devices, air vents and the motor housing free of dirt and dust as far as possible. Wipe the equipment with a clean cloth or blow it with compressed air at low pressure.
- We recommend that you clean the device immediately each time you have finished using it.
- Clean the equipment regularly with a moist cloth and some soft soap. Do not use cleaning agents or solvents; these could attack the plastic parts of the equipment. Ensure that no water can seep into the device. The ingress of water into an electric tool increases the risk of an electric shock.

8.2 Maintenance

There are no parts inside the equipment which require additional maintenance.

8.3 Ordering spare parts and accessories

Please provide the following information when ordering spare parts:

- Type of unit
- Article number of the unit
- ID number of the unit
- Spare part number of the required spare part

For our latest prices and information please go to www.Einhell-Service.com



Tip! For good results we recommend high-quality accessories from **kwb**!
www.kwb.eu
welcome@kwb.eu

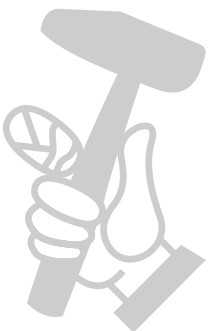

9. Disposal and recycling

The equipment is supplied in packaging to prevent it from being damaged in transit. The raw materials in this packaging can be reused or recycled. The equipment and its accessories are made of various types of material, such as metal and plastic. Never place defective equipment in your household refuse. The equipment should be taken to a suitable collection center for proper disposal. If you do not know the whereabouts of such a collection point, you should ask in your local council offices.

10. Storage

Store the equipment and accessories in a dark and dry place at above freezing temperature. The ideal storage temperature is between 5 and 30 °C. Store the electric tool in its original packaging.

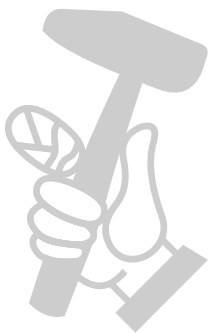

GB



For EU countries only

Never place any electric power tools in your household refuse.

To comply with European Directive 2012/19/EC concerning old electric and electronic equipment and its implementation in national laws, old electric power tools have to be separated from other waste and disposed of in an environment-friendly fashion, e.g. by taking to a recycling depot.

Recycling alternative to the return request:

As an alternative to returning the equipment to the manufacturer, the owner of the electrical equipment must make sure that the equipment is properly disposed of if he no longer wants to keep the equipment. The old equipment can be returned to a suitable collection point that will dispose of the equipment in accordance with the national recycling and waste disposal regulations. This does not apply to any accessories or aids without electrical components supplied with the old equipment.

The reprinting or reproduction by any other means, in whole or in part, of documentation and papers accompanying products is permitted only with the express consent of the Einhell Germany AG.

Subject to technical changes

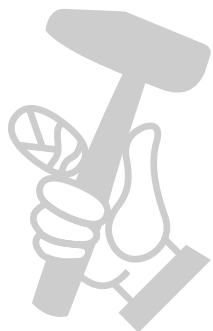

МАГАЗИН МАКІСТОРА®
БАШ МАКІСТОРА®
ПРОФЕСІОНАЛНІ РЕШЕННЯ

Service information

We have competent service partners in all countries named on the guarantee certificate whose contact details can also be found on the guarantee certificate. These partners will help you with all service requests such as repairs, spare and wearing part orders or the purchase of consumables.

Please note that the following parts of this product are subject to normal or natural wear and that the following parts are therefore also required for use as consumables.

Category	Example
Wear parts*	
Consumables*	Glue sticks
Missing parts	

* Not necessarily included in the scope of delivery!

In the event of defects or faults, please register the problem on the internet at www.Einhell-Service.com. Please ensure that you provide a precise description of the problem and answer the following questions in all cases:

- Did the equipment work at all or was it defective from the beginning?
- Did you notice anything (symptom or defect) prior to the failure?
- What malfunction does the equipment have in your opinion (main symptom)? Describe this malfunction.

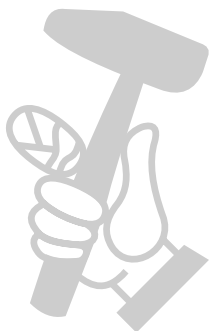

Warranty certificate

Dear Customer,

All of our products undergo strict quality checks to ensure that they reach you in perfect condition. In the unlikely event that your device develops a fault, please contact our service department at the address shown on this guarantee card. You can also contact us by telephone using the service number shown. Please note the following terms under which guarantee claims can be made:

1. These guarantee terms apply to consumers only, i.e. natural persons intending to use this product neither for their commercial activities nor for any other self-employed activities. These warranty terms regulate additional warranty services, which the manufacturer mentioned below promises to buyers of its new products in addition to their statutory rights of guarantee. Your statutory guarantee claims are not affected by this guarantee. Our guarantee is free of charge to you.
2. The warranty services cover only defects due to material or manufacturing faults on a product which you have bought from the manufacturer mentioned below and are limited to either the rectification of said defects on the product or the replacement of the product, whichever we prefer. Please note that our devices are not designed for use in commercial, trade or professional applications. A guarantee contract will not be created if the device has been used by commercial, trade or industrial business or has been exposed to similar stresses during the guarantee period.
3. The following are not covered by our guarantee:
 - Damage to the device caused by a failure to follow the assembly instructions or due to incorrect installation, a failure to follow the operating instructions (for example connecting it to an incorrect mains voltage or current type) or a failure to follow the maintenance and safety instructions or by exposing the device to abnormal environmental conditions or by lack of care and maintenance.
 - Damage to the device caused by abuse or incorrect use (for example overloading the device or the use of unapproved tools or accessories), ingress of foreign bodies into the device (such as sand, stones or dust, transport damage), the use of force or damage caused by external forces (for example by dropping it).
 - Damage to the device or parts of the device caused by normal or natural wear or tear or by normal use of the device.
4. The guarantee is valid for a period of 24 months starting from the purchase date of the device. Guarantee claims should be submitted before the end of the guarantee period within two weeks of the defect being noticed. No guarantee claims will be accepted after the end of the guarantee period. The original guarantee period remains applicable to the device even if repairs are carried out or parts are replaced. In such cases, the work performed or parts fitted will not result in an extension of the guarantee period, and no new guarantee will become active for the work performed or parts fitted. This also applies if an on-site service is used.
5. To make a claim under the guarantee, please register the defective device at: www.Einhell-Service.com. Please keep your bill of purchase or other proof of purchase for the new device. Devices that are returned without proof of purchase or without a rating plate shall not be covered by the guarantee, because appropriate identification will not be possible. If the defect is covered by our guarantee, then the item in question will either be repaired immediately and returned to you or we will send you a new replacement.

Of course, we are also happy offer a chargeable repair service for any defects which are not covered by the scope of this guarantee or for units which are no longer covered. To take advantage of this service, please send the device to our service address.

Also refer to the restrictions of this warranty concerning wear parts, consumables and missing parts as set out in the service information in these operating instructions.

