



**WACKER  
NEUSON**

Ersatzteilkatalog  
Spare parts catalog  
Catálogo de piezas de repuesto  
Catalogue de pièces de rechange

**Modularer Innenrüttler  
Modular Internal Vibrator  
Vibradores internos modulares  
Vibrateurs internes modulaires**

**M1500/230 EU**



Invalid path 'w:\nad.net\global\ALL\LNZ\Global\_ALL\_SCHEMA\_ST4\SAP\_data\_export\_SP100\_5100005142\_100\_Q4'

Type	M1500/230 EU
Material Number	5100005142
Version	100
Language	de   en   es   fr



[www.wackerneuson.com](http://www.wackerneuson.com)



Copyright © 12.2022  
Wacker Neuson Produktion GmbH & Co. KG  
Printed in Germany.  
All rights reserved.

Ein Typenschild mit Typ, Artikelnummer, Version und Maschinen-Nummer ist an jedem Gerät angebracht. Die Daten von diesem Schild bitte notieren, damit sie auch bei Verlust oder Beschädigung des Schildes noch vorhanden sind. Der Typ, die Artikelnummer, die Versions-Nummer und die Maschinen-Nummer sind bei der Ersatzteilbestellung oder Nachfragen bezüglich Service-Informationen stets erforderlich.

Bei den in den Ersatzteillisten fettgedruckten Nummern handelt es sich um empfohlene Ersatzteile. Dies bedeutet, daß diese Teile bei normalen Anwendungsbedingungen natürlicher Abnutzung ausgesetzt sind und gelegentlich ersetzt oder überarbeitet werden müssen. Es wird geraten, diese Teile auf Lager bereit zu haben, um für Service-Arbeiten an diesem Gerät vorbereitet zu sein. Lagerbestände für diese und andere Teile, welche für ausgiebigere Reparaturarbeiten benötigt werden, können je nach Service-Gewohnheiten der einzelnen Kunden variieren.

Die Nummern meines Gerätes sind:

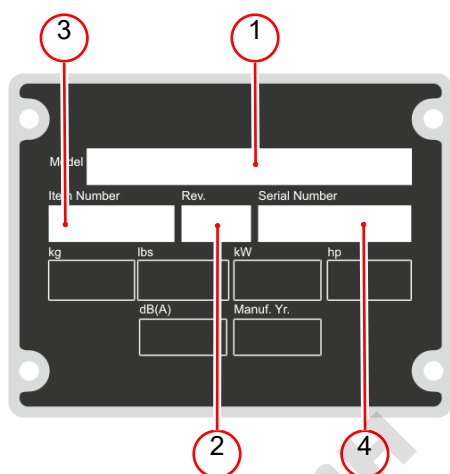

1. Typ
2. Version
3. Artikel-Nr.
4. Maschinen-Nr.

#### Umrechnungstabelle

Volumeneinheit	
1 ml	0.034 US fl.oz.
1 l	0.260 gal
Längeneinheit	
1 mm	0.039 in
1 m	3.280 ft
Gewicht	
1 kg	2.200 lbs
1 g	0.035 oz
Geschwindigkeit	
1 km/h	0.620 mph
Drehmoment	
1 Nm	0.740 ft.lbs

A nameplate listing the Model Number, Item Number, Revision, and Serial Number is attached to each unit. Please record the information found on this plate so it will be available should the nameplate become lost or damaged. When ordering parts or requesting service information, you will always be asked to specify the model, item number, revision number, and serial number of the unit.

Part Numbers appearing in boldface type are recommended spare parts. This means that these parts are subject to wear under normal operating conditions and may require periodic service or replacement. It is recommended that these items be stocked to meet the expected service requirements of this model. Actual stocking quantities of these and other parts used in more extensive repairs will depend on the service practices of each customer.

My machine's numbers are:

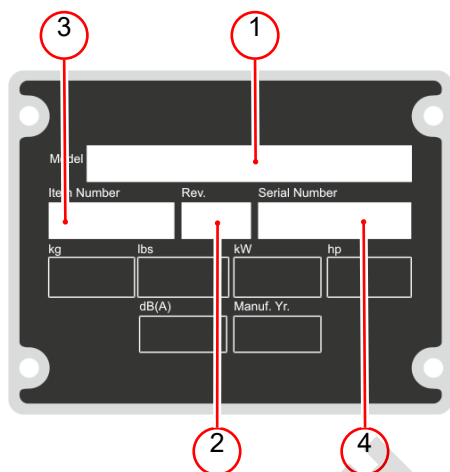

1. Model
2. Revision
3. Item No.
4. Serial No.

**Conversion table**

Volume unit	
1 ml	0.034 US fl.oz.
1 l	0.260 gal
Unit of length	
1 mm	0.039 in
1 m	3.280 ft
Weight	
1 kg	2.200 lbs
1 g	0.035 oz
Speed	
1 km/h	0.620 mph
Torque	
1 Nm	0.740 ft.lbs

Una placa de identificación con el modelo, número de referencia, nivel de revisión y número de serie ha sido añadida en cada máquina. Favor de anotar los datos en la placa en caso de que la placa de identificación sea destruida o perdida. En todos los pedidos para repuestos necesita siempre el modelo, el número de referencia, el nivel de revisión y el número de serie de la máquina en cuestión.

Los números de partes en negritas en las Listas Ilustradas de Partes son los repuestos recomendados, esto quiere decir que estas partes se desgastarán bajo circunstancias de funcionamiento normales y pueden requerir servicio periódico o su reemplazo. Se recomienda que el cliente mantenga un abastecimiento adecuado de estas partes para poder satisfacer la demanda requerida por el servicio a la máquina. La cantidad de repuestos que el cliente necesitará para reparaciones dependerá de la póliza de servicio de cada cliente.

Los números de mi máquina son:

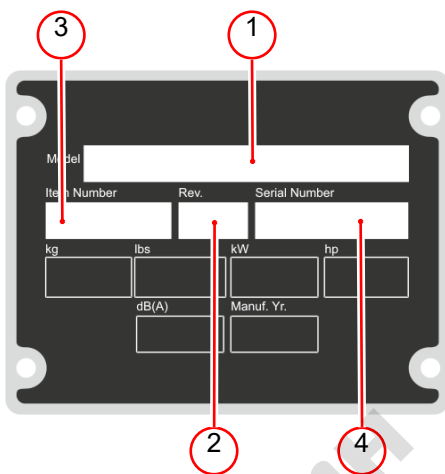

1. Modelo
2. Nivel de revisión
3. Número de referencia
4. Número de Serie

#### Tabla de conversión

Unidad de volumen	
1 ml	0.034 US fl.oz.
1 l	0.260 gal
Unidad de longitud	
1 mm	0.039 in
1 m	3.280 ft
Peso	
1 kg	2.200 lbs
1 g	0.035 oz
Velocidad	
1 km/h	0.620 mph
Par de apriete	
1 Nm	0.740 ft.lbs

Une plaque signalétique mentionnant le modèle, le numéro de référence, le niveau de revision et le numéro de série est fixée sur chaque machine. Veuillez noter les informations relevées sur cette plaque de façon à ce qu'elles soient toujours disponibles si la plaque signalétique venait à être perdue ou endommagée. Lorsque vous commandez des pièces détachées ou vous sollicitez des informations après-vente, on vous demandera toujours de préciser le modèle, le numéro de référence, le niveau de revision et le numéro de série de la machine.

Les numéros de pièces imprimés en caractères gras dans les Listes des Pièces Détachées de ce manuel sont les pièces détachées recommandées par la Wacker. Cela veut dire que ces pièces sont sujettes à usure dans des conditions de travail normales et peuvent nécessiter de l'entretien ou leur remplacement. Nous recommandons que vous disposez d'un stock de ces pièces pour pouvoir satisfaire la demande d'entretien de cette machine. Le client doit décider lui-même de la quantité exacte de pièces de rechange qu'il disposera dans ses stocks.

Les numéros de ma machine son :

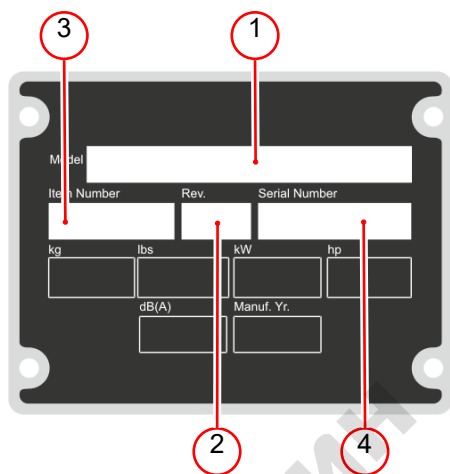

- 1. Typ
- 2. Version
- 3. Artikel-Nr.
- 4. Maschinen-Nr.

**Table de conversion**

Unité de volume	
1 ml	0.034 US fl.oz.
1 l	0.260 gal
Unité de longueur	
1 mm	0.039 in
1 m	3.280 ft
Poids	
1 kg	2.200 lbs
1 g	0.035 oz
Vitesse	
1 km/h	0.620 mph
Couple de serrage	
1 Nm	0.740 ft.lbs

Antriebsmotor Drive engine Motor de accionamiento Moteur de commande .....	10
---	----

Motor Engine Motor Moteur .....	12
--	----

Aufkleber Labels Calcomanías Autocollants .....	14
--	----

Zubehör Accessories Accesorios Accessoires	
---	--

Biegewellen SM XE Flex shafts sm xe Ejes flexibles sm xe Transmission flexible sm xe .....	16
---	----

Biegewellen SM XS Flex shafts sm xs Ejes flexibles sm xs Transmission flexible sm xs .....	18
---	----

Flasche H 25 Head h 25 Capezote h 25 Aiguilles h 25 .....	20
--	----

Flasche H 35 Head h 35 Capezote h 35 Aiguilles h 35 .....	22
--	----

Flasche H 45 Head h 45 Capezote h 45 Aiguilles h 45 .....	24
--	----

Flasche H 55 Head h 55 Capezote h 55 Aiguilles h 55 .....	26
--	----

Flasche H 25S Head h 25s Capezote h 25s Aiguilles h 25s .....	28
--	----

Flasche H 35S Head h 35s Capezote h 35s Aiguilles h 35s .....	30
--	----



Flasche H 45S Head h 45s Capezote h 45s Aiguilles h 45s .....	32
--	----

Flasche H 25HA Head h 25ha Capezote h 25ha Aiguilles h 25ha .....	34
--	----

Flasche H 35HA Head h 35ha Capezote h 35ha Aiguilles h 35ha .....	36
--	----

Flasche H 45HA Head h 45ha Capezote h 45ha Aiguilles h 45ha .....	38
--	----

Flasche H 50HA Head h 50ha Capezote h 50ha Aiguilles h 50ha .....	40
--	----

Schultergurt Shoulder belt Correa Ruban .....	42
--	----

Biegewelle SM 1S Flex shafts sm 1s Ejes flexibles sm 1s Transmission flexible sm 1s .....	44
--	----

Biegewelle SM 2S Flex shafts sm 2s Ejes flexibles sm 2s Transmission flexible sm 2s .....	46
--	----

Biegewelle SM 3S Flex shafts sm 3s Ejes flexibles sm 3s Transmission flexible sm 3s .....	48
--	----

Biegewelle SM 4S Flex shafts sm 4s Ejes flexibles sm 4s Transmission flexible sm 4s .....	50
--	----

Biegewelle SM 5S Flex shafts sm 5s Ejes flexibles sm 5s Transmission flexible sm 5s .....	52
--	----

Biegewelle SM 7S Flex shafts sm 7s Ejes flexibles sm 7s Transmission flexible sm 7s .....	54
--	----



Biegewelle SM 9S Flex shafts sm 9s Ejes flexibles sm 9s Transmission flexible sm 9s .....	56
Biegewelle SM 0S Flex shafts sm 0s Ejes flexibles sm 0s Transmission flexible sm 0s .....	58
Biegewelle SM 1E Flex shafts sm 1e Ejes flexibles sm 1e Transmission flexible sm 1e .....	60
Biegewelle SM 2E Flex shafts sm 2e Ejes flexibles sm 2e Transmission flexible sm 2e .....	62
Biegewelle SM 3E Flex shafts sm 3e Ejes flexibles sm 3e Transmission flexible sm 3e .....	64
Biegewelle SM 4E Flex shafts sm 4e Ejes flexibles sm 4e Transmission flexible sm 4e .....	66
Biegewelle SM 5E Flex shafts sm 5e Ejes flexibles sm 5e Transmission flexible sm 5e .....	68
Biegewelle SM 7E Flex shafts sm 7e Ejes flexibles sm 7e Transmission flexible sm 7e .....	70

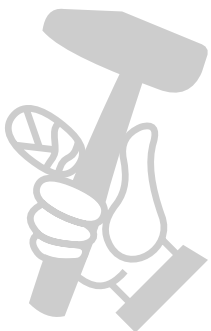

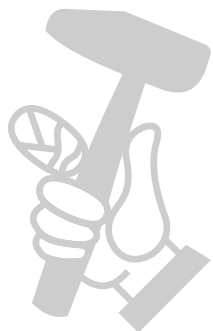
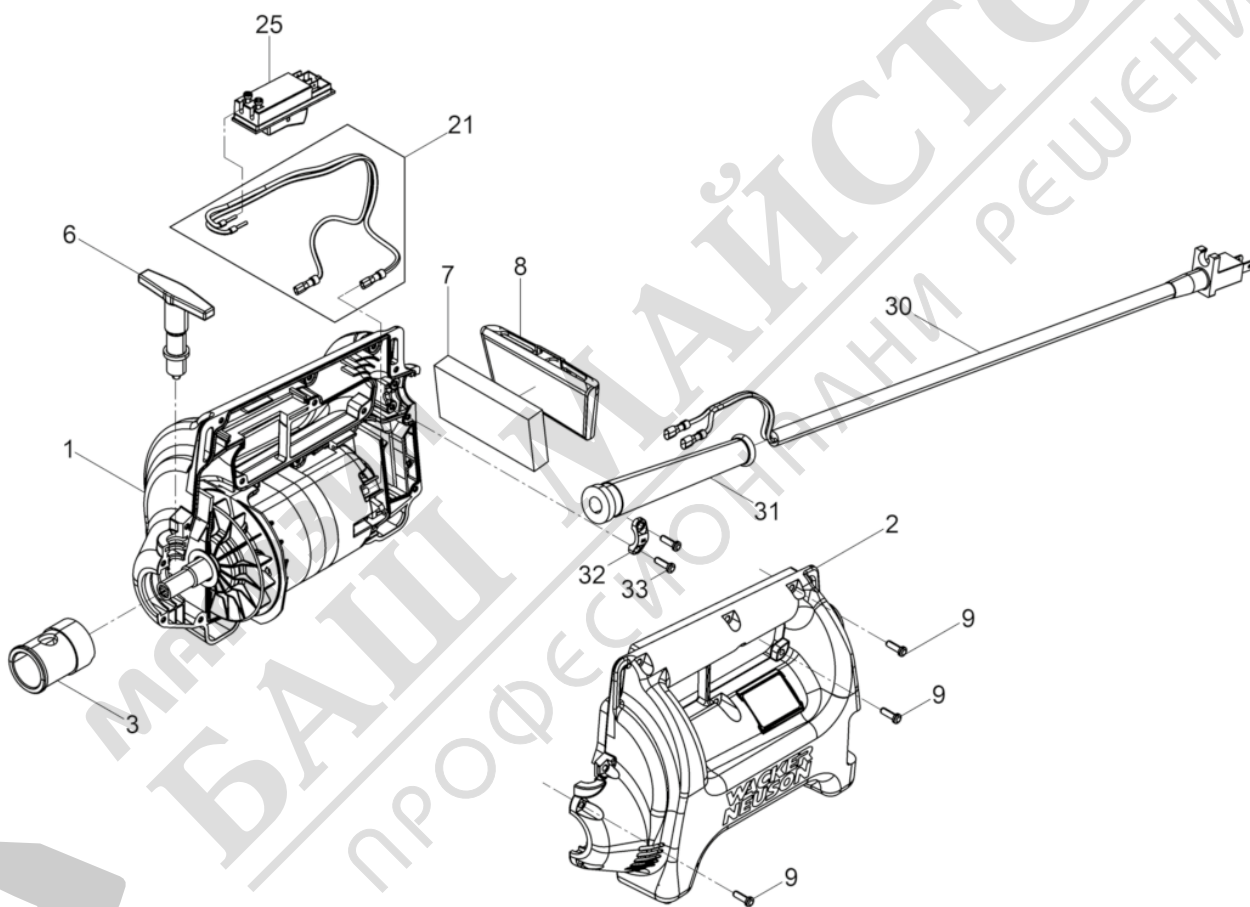

Pos. Item	Artikel Nr. Item no.	Pc.	Unit	Beschreibung Descripción	Description Description	Abm. Dim.	Norm Standard
						Drehmoment Torque	Schmierstoff Lubricant
1	5100010489	1	pc	Gehäuse Rechts Carcasa derecha	Housing right Carter droite		
2	5100010488	1	pc	Gehäuse Links Carcasa izquierda	Housing left Carter gauche		
3	5100068041	1	pc	Buchse Buje	Bush Boîte		
6	5100009577	1	pc	Vorsteckstift Pasador	Detent pin Goupille		
7	5100010864	1	pc	Filterelement Elemento del filtro	Filter element Élément du filtre		
8	5100010490	1	pc	Filtergehäuse Carcasa de filtro	Filter housing Carter de filtre		
9	5100010127	19	pc	Linsenkopfschraube Tornillo gota de sebo	Oval head screw Vis noyée lentiforme	5x16	
21	5100015414	1	pc	Verbindungsleitung Kpl. Línea de conexión cpl.	Supply line cpl. Câble d'amenée cpl.		
25	5100010900	1	pc	Schalter Interruptor	Switch Interrupteur		
30	5100010646	1	pc	Zuleitungskabel M. Stecker Cable de alimentación conenchufe	Power supply cable with plug Câble damenée avec fiche		
31	5000064242	1	pc	Gummitülle Casquillo de goma	Rubber funnel Passe fil en caoutchouc		
32	5000106220	1	pc	Schelle Abrazadera	Clamp Collier		
33	5100010127	2	pc	Linsenkopfschraube Tornillo gota de sebo	Oval head screw Vis noyée lentiforme	5x16	

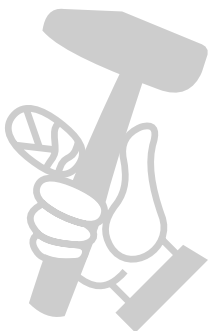

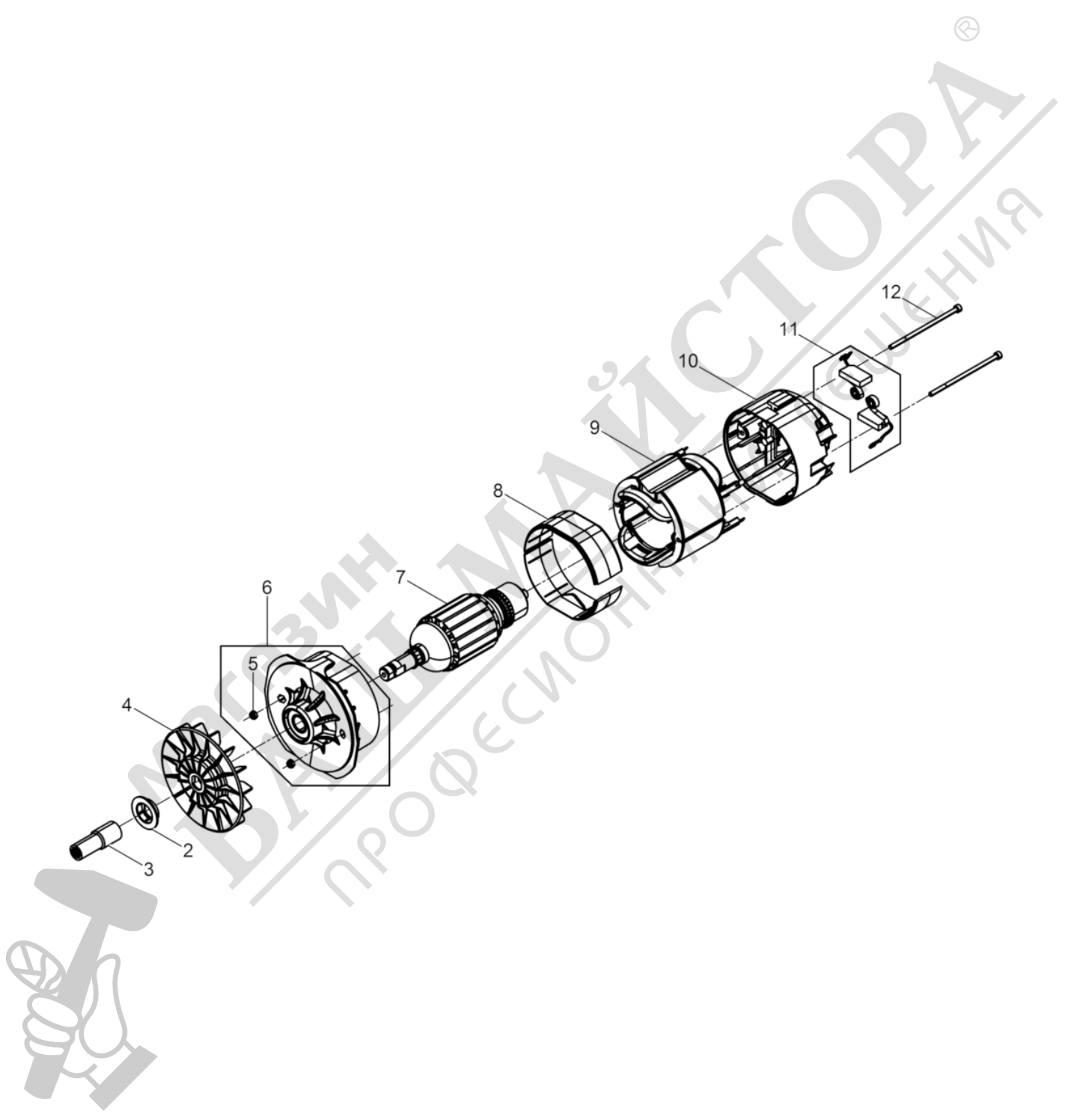

Pos. Item	Artikel Nr. Item no.	Pc.	Unit	Beschreibung Descripción	Description Description	Abm. Dim.	Norm Standard
						Drehmoment Torque	Schmierstoff Lubricant
2	5100005447	1	pc	Labyrinth-Dichtung Junta laberíntica	Labyrinth seal Garniture en labyrinthe		
3	5000053934	1	pc	Adapter Adaptador	Adaptor Adaptateur		
4	5100004469	1	pc	Lüfterrad Rueda del ventilador	Fan wheel Roue d'aeration		
5	5000105210	2	pc	Sechskantmutter Tuerca hexagonal	Hexagon nut Écrou hexagonal	VM4	DIN980
6	5100010853	1	pc	Lagerschild Vorn Placa de cojinete avant	Bearing bracket front Bride palier frente		
7	5100000661	1	pc	Rotor 230V Rotor 230v	Rotor 230v Rotor 230v		
8	5100009988	1	pc	Distanzring Anillo distanciador	Spacer ring Rondelle d'écartement		
9	5100000662	1	pc	Stator 230V Estator 230v	Stator 230v Stator 230v		
10	5100010852	1	pc	Lagerschild Hinten Placa de cojinete atrás	Bearing bracket rear Bride palier arrière		
11	5100010863	1	pc	Kohlebürstensatz Escobilla (juego)	Carbon brush (set) Balai de charbon (jeu)		
12	5100010880	2	pc	Zylinderschraube Tornillo cilíndrico	Cheese head screw Vis à tête cylindrique	M 4x 90	

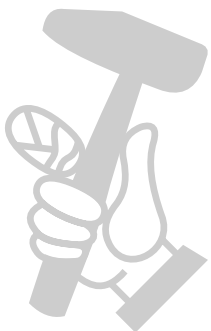

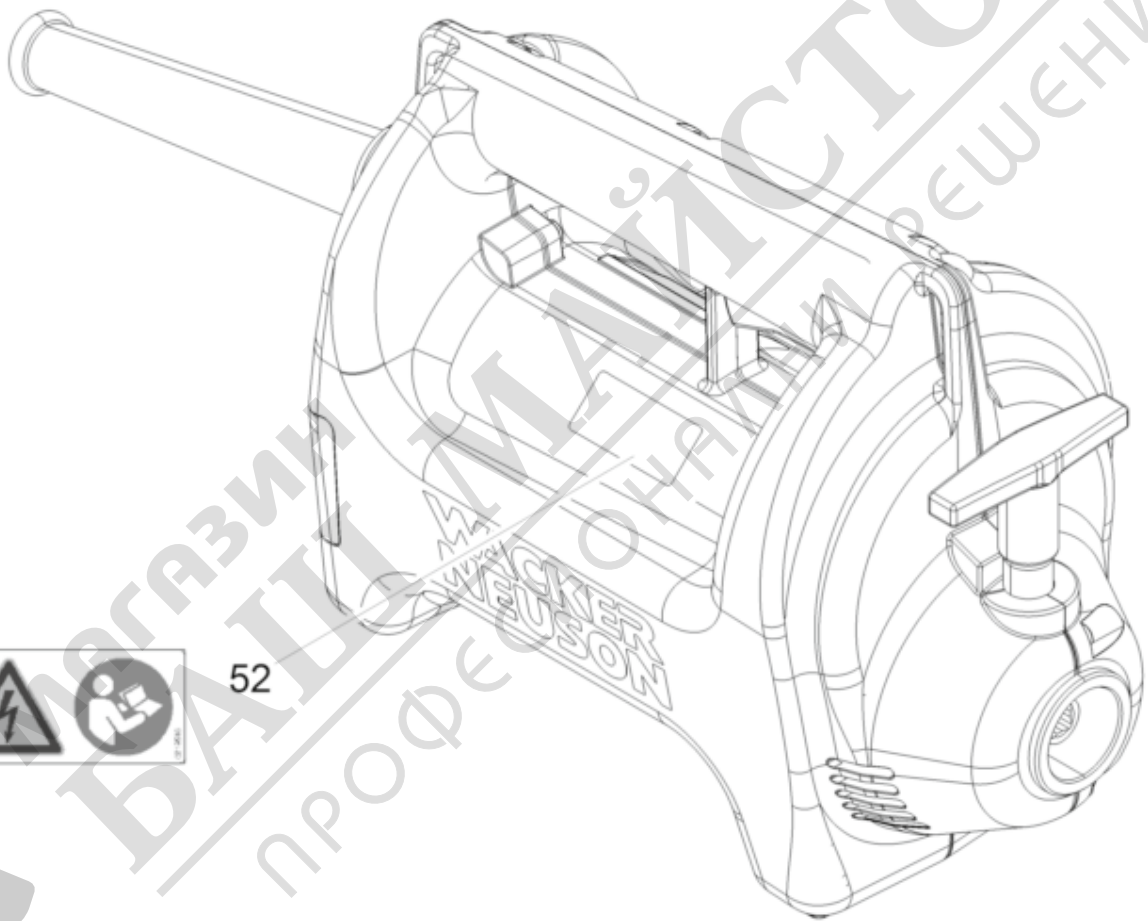

52

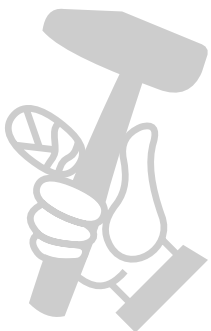

Pos. Item	Artikel Nr. Item no.	Pc.	Unit	Beschreibung Descripción	Description Description	Abm. Dim.	Norm Standard
						Drehmoment Torque	Schmierstoff Lubricant
52	5000219516	1	pc	Aufkleber Calcomania	Label Autocollant		

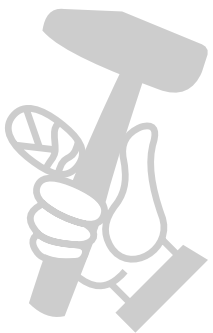

МАГАЗИН МАЙСТОРА  
БАШ МАЙСТОРА  
ПРОФЕСИОНАЛНИ РЕШЕНИЯ





Pos. Item	Artikel Nr. Item no.	Pc.	Unit	Beschreibung Descripción	Description Description	Abm. Dim.	Norm Standard
						Drehmoment Torque	Schmierstoff Lubricant
1	5100005703	1	pc	Biegewelle Ejes flexibles sm 1e	Flex shafts sm 1e Transmission flexible sm 1e		
1	5100005704	1	pc	Biegewelle Ejes flexibles sm 2e	Flex shafts sm 2e Transmission flexible sm 2e		
1	5100005705	1	pc	Biegewelle Ejes flexibles sm 4e	Flex shafts sm 4e Transmission flexible sm 4e		
1	5100028340	1	pc	Biegewelle SM 3E Ejes flexibles sm 3e	Flex shaft sm 3e Transmission flexible sm 3e		
1	5100028341	1	pc	Biegewelle SM 5E Ejes flexibles sm 5e	Flex shaft sm 5e Transmission flexible sm 5e		
1	5100028342	1	pc	Biegewelle SM 7E Ejes flexibles sm 7e	Flex shaft sm 7e Transmission flexible sm 7e		
2	5100022727	1	pc	Biegewellenseele SM1E Alma sm1e	Shaft core sm1e Arbre à transmission flexible		
2	5100022728	1	pc	Biegewellenseele SM2E Alma sm2e	Shaft core sm2e Arbre à transmission flexible		
2	5100022729	1	pc	Biegewellenseele SM4E Alma sm4e	Shaft core sm4e Arbre à transmission flexible		
2	5100031298	1	pc	Biegewellenseele SM3E Alma sm3e	Shaft core sm3e Arbre à transmission flexible		
2	5100031299	1	pc	Biegewellenseele SM5E Alma sm5e	Shaft core sm5e Arbre à transmission flexible		
2	5100031330	1	pc	Biegewellenseele SM7E Alma sm7e	Shaft core sm7e Arbre à transmission flexible		
3	5000071584	1	pc	Kupplung Acoplamiento	Coupling Couplage		

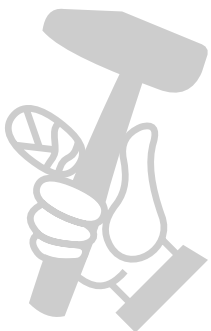



Pos. Item	Artikel Nr. Item no.	Pc.	Unit	Beschreibung Descripción	Description Description	Abm. Dim.	Norm Standard
						Drehmoment Torque	Schmierstoff Lubricant
1	5100005706	1	pc	Biegewelle Ejes flexibles sm 0s	Flex shafts sm 0s Transmission flexible sm 0s		
1	5100005707	1	pc	Biegewelle Ejes flexibles sm 1s	Flex shafts sm 1s Transmission flexible sm 1s		
1	5100005708	1	pc	Biegewelle Ejes flexibles sm 2s	Flex shafts sm 2s Transmission flexible sm 2s		
1	5100005709	1	pc	Biegewelle Ejes flexibles sm 3s	Flex shafts sm 3s Transmission flexible sm 3s		
1	5100005710	1	pc	Biegewelle Ejes flexibles sm 4s	Flex shafts sm 4s Transmission flexible sm 4s		
1	5100005711	1	pc	Biegewelle Ejes flexibles sm 5s	Flex shafts sm 5s Transmission flexible sm 5s		
1	5100005712	1	pc	Biegewelle Ejes flexibles sm 7s	Flex shafts sm 7s Transmission flexible sm 7s		
1	5100005713	1	pc	Biegewelle Ejes flexibles sm 9s	Flex shafts sm 9s Transmission flexible sm 9s		
2	5100022651	1	pc	Biegewellenseele SM0S Alma sm0s	Shaft core sm0s Arbre à transmission flexible		
2	5100022652	1	pc	Biegewellenseele SM1S Alma sm1s	Shaft core sm1s Arbre à transmission flexible		
2	5100022653	1	pc	Biegewellenseele SM2S Alma sm2s	Shaft core sm2s Arbre à transmission flexible		
2	5100022654	1	pc	Biegewellenseele SM3S Alma sm3s	Shaft core sm3s Arbre à transmission flexible		
2	5100022655	1	pc	Biegewellenseele SM4S Alma sm4s	Shaft core sm4s Arbre à transmission flexible		
2	5100022656	1	pc	Biegewellenseele SM5S Alma sm5s	Shaft core sm5s Arbre à transmission flexible		
2	5100022657	1	pc	Biegewellenseele SM7S Alma sm7s	Shaft core sm7s Arbre à transmission flexible		
2	5100022658	1	pc	Biegewellenseele SM9S Alma sm9s	Shaft core sm9s Arbre à transmission flexible		
3	5000071584	1	pc	Kupplung Acoplamiento	Coupling Couplage		

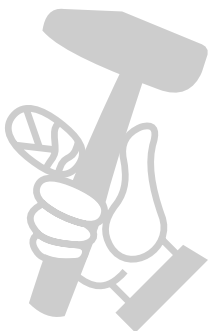

Flasche H 25  
Head h 25  
Capezote h 25  
Aiguilles h 25

M1500/230 EU

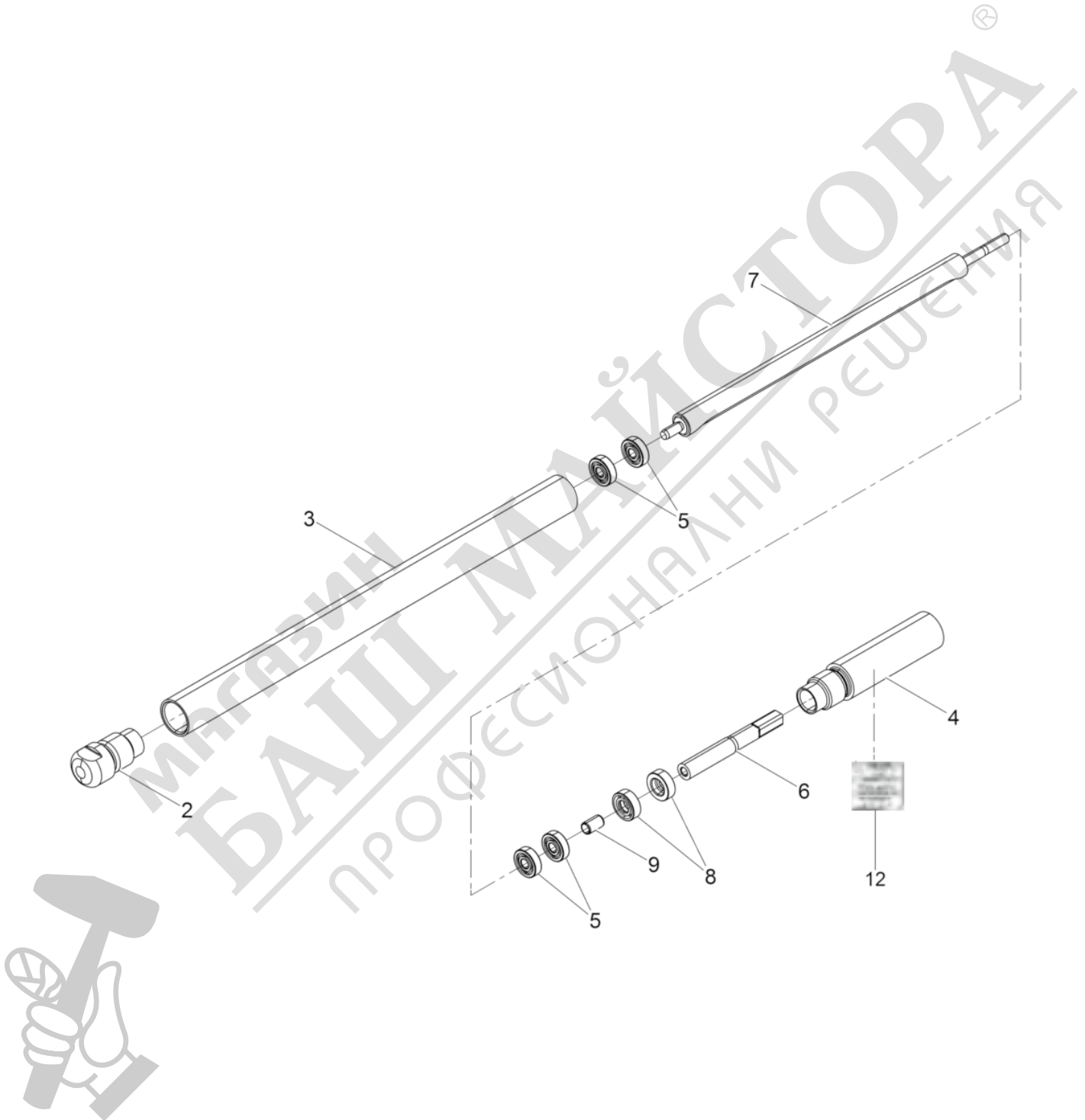

Pos. Item	Artikel Nr. Item no.	Pc.	Unit	Beschreibung Descripción	Description Description	Abm. Dim.	Norm Standard
						Drehmoment Torque	Schmierstoff Lubricant
2	5000085448	1	pc	Verschlusskappe Tapa de cierre	Nose cap Chape de fermeture		
3	5000029746	1	pc	Gehäuse Carcasa	Housing Carter		
4	5000029747	1	pc	Adapter Adaptador	Adaptor Adaptateur		
5	5000078715	4	pc	Rillenkugellager Rodamiento de bolas	Grooved ball bearing Roulement à billes		
6	5000029748	1	pc	Wellenseelenadapter Adaptador alma	Inner core adaptor Adaptateur arbre à		
7	5000029745	1	pc	Unwucht Masa excéntrica	Eccentric weight Balourd		
8	5000029778	2	pc	Wellendichtring Sello del eje	Shaft seal Bague d'étanchéité		
9	5000030715	1	pc	Abstandshülse Manguito distanciador	Distance sleeve Douille d'écartement		
12	5100045462	1	pc	Aufkleber Calcomania	Label Autocollant		

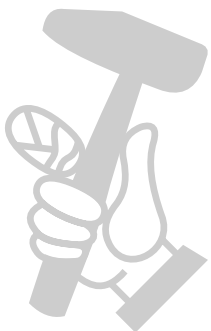

Flasche H 35  
Head h 35  
Capezote h 35  
Aiguilles h 35

M1500/230 EU

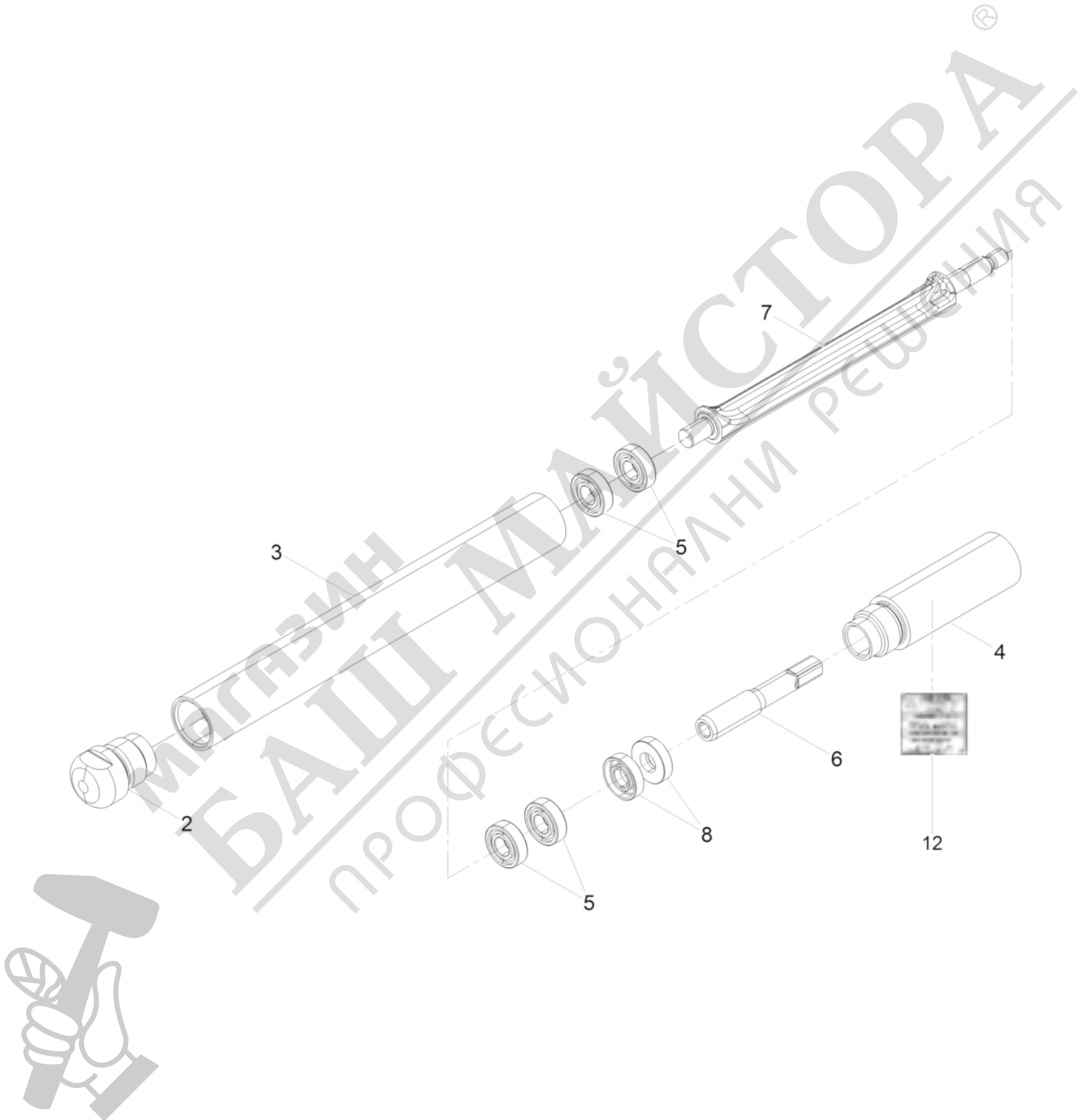

Pos. Item	Artikel Nr. Item no.	Pc.	Unit	Beschreibung Descripción	Description Description	Abm. Dim.	Norm Standard
						Drehmoment Torque	Schmierstoff Lubricant
2	5000085449	1	pc	Verschlusskappe Tapa de cierre	Nose cap Chape de fermeture		
3	5000029753	1	pc	Gehäuse Carcasa	Housing Carter		
4	5000029754	1	pc	Adapter Adaptador	Adaptor Adaptateur		
5	5000078716	4	pc	Rillenkugellager Rodamiento de bolas	Grooved ball bearing Roulement à billes		
6	5000029755	1	pc	Wellenseelenadapter Adaptador alma	Inner core adaptor Adaptateur arbre à		
7	5000080716	1	pc	Unwucht Masa excéntrica	Eccentric weight Balourd		
8	5000029781	2	pc	Wellendichtring Sello del eje	Shaft seal Bague d'étanchéité		
12	5100045462	1	pc	Aufkleber Calcomania	Label Autocollant		

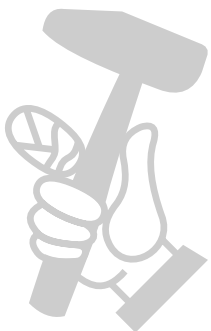

МАГАЗИН МАЙСТОР  
БАШ МАЙСТОР  
ПРОФЕСИОНАЛНИ РЕШЕНИЯ

Flasche H 45  
Head h 45  
Capezote h 45  
Aiguilles h 45

M1500/230 EU





Pos. Item	Artikel Nr. Item no.	Pc.	Unit	Beschreibung Descripción	Description Description	Abm. Dim.	Norm Standard
						Drehmoment Torque	Schmierstoff Lubricant
2	5000085450	1	pc	Verschlusskappe Tapa de cierre	Nose cap Chape de fermeture		
3	5000029760	1	pc	Gehäuse Carcasa	Housing Carter		
4	5000029761	1	pc	Adapter Adaptador	Adaptor Adaptateur		
5	5000078717	4	pc	Rillenkugellager Rodamiento de bolas	Grooved ball bearing Roulement à billes		
6	5000029755	1	pc	Wellenseelenadapter Adaptador alma	Inner core adaptor Adaptateur arbre à		
7	5000080717	1	pc	Unwucht Masa excéntrica	Eccentric weight Balourd		
8	5000029784	2	pc	Wellendichtring Sello del eje	Shaft seal Bague d'étanchéité		
12	5100045462	1	pc	Aufkleber Calcomania	Label Autocollant		

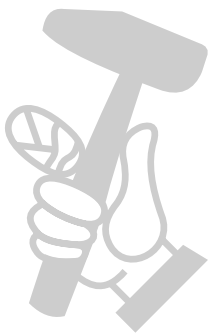

МАГАЗИН МАЙСТОР  
БАШ МАЙСТОР  
ПРОФЕСИОНАЛНИ РЕШЕНИЯ

Flasche H 55  
Head h 55  
Capezote h 55  
Aiguilles h 55

M1500/230 EU

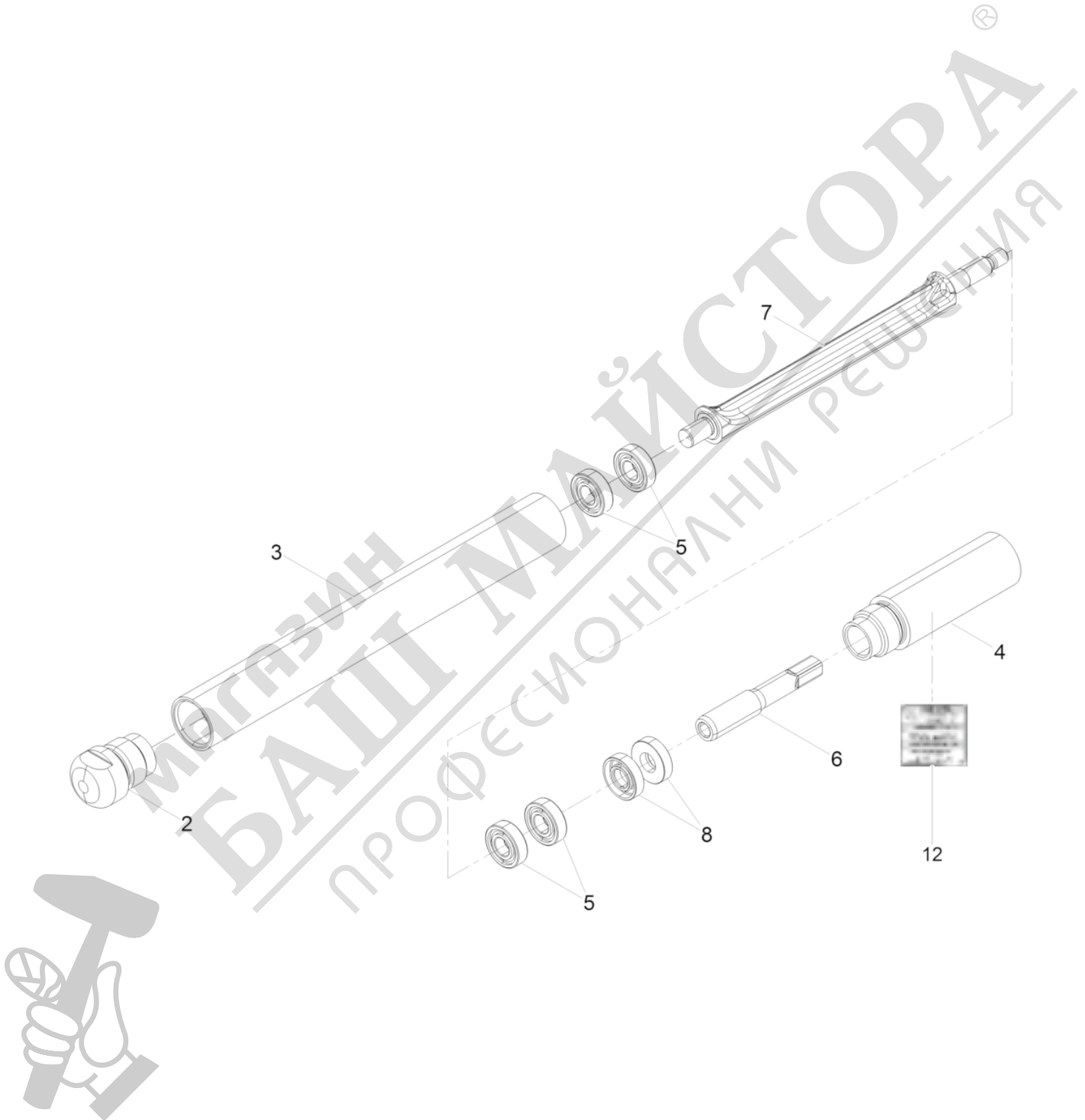

Pos. Item	Artikel Nr. Item no.	Pc.	Unit	Beschreibung Descripción	Description Description	Abm. Dim.	Norm Standard
						Drehmoment Torque	Schmierstoff Lubricant
2	5000085451	1	pc	Verschlusskappe Tapa de cierre	Nose cap Chape de fermeture		
3	5000029766	1	pc	Gehäuse Carcasa	Housing Carter		
4	5000029767	1	pc	Adapter Adaptador	Adaptor Adaptateur		
5	5000078718	4	pc	Rillenkugellager Rodamiento de bolas	Grooved ball bearing Roulement à billes		
6	5000029755	1	pc	Wellenseelenadapter Adaptador alma	Inner core adaptor Adaptateur arbre à		
7	5000029765	1	pc	Unwucht Masa excéntrica	Eccentric weight Balourd		
8	5000029787	2	pc	Wellendichtring Sello del eje	Shaft seal Bague d'étanchéité		
12	5100045462	1	pc	Aufkleber Calcomania	Label Autocollant		

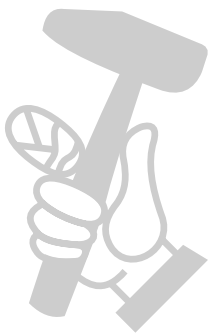

МАГАЗИН МАЙСТОР  
БАШ МАЙСТОР  
ПРОФЕСИОНАЛНИ РЕШЕНИЯ

Flasche H 25S  
Head h 25s  
Capezote h 25s  
Aiguilles h 25s

M1500/230 EU

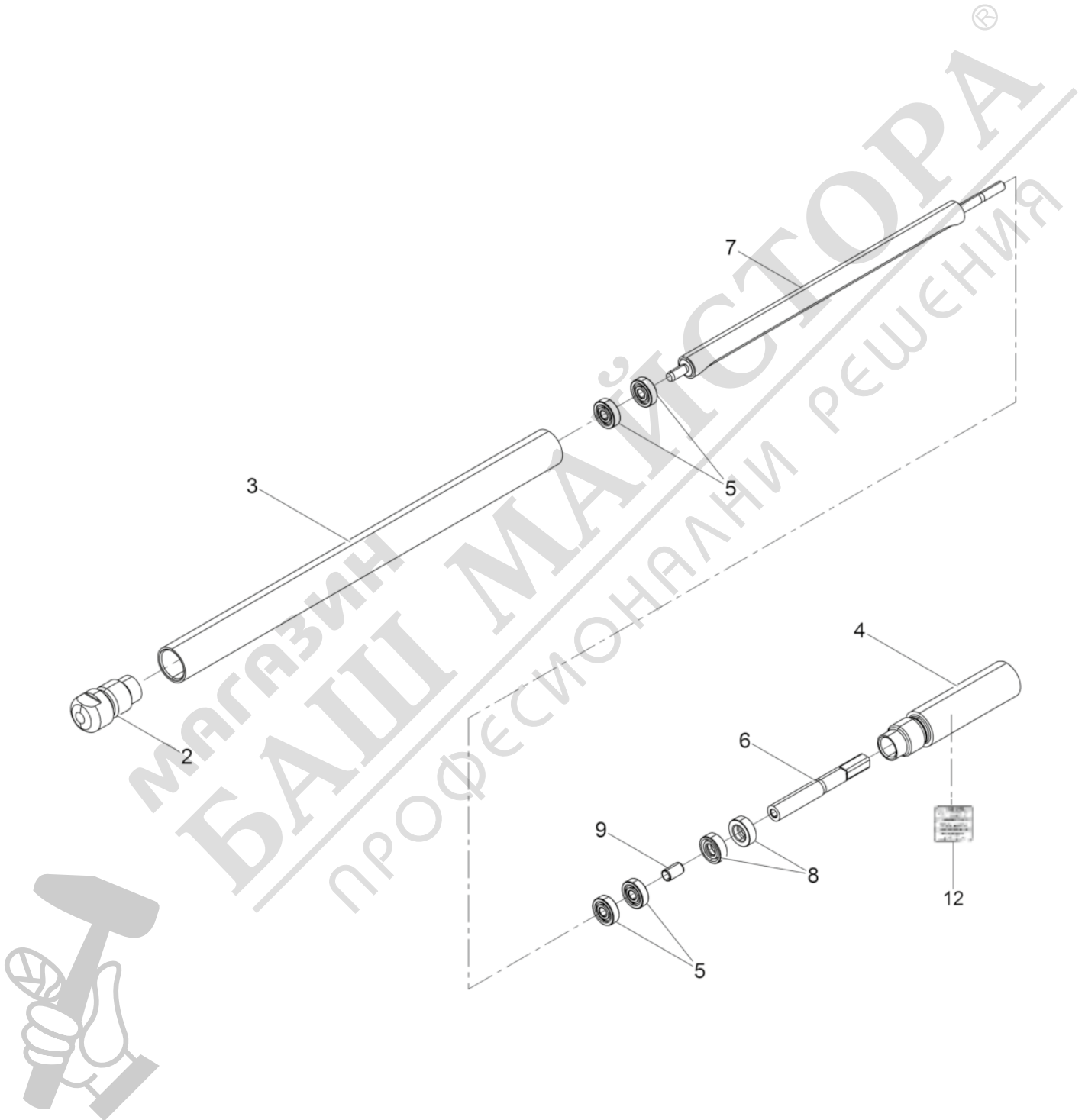

Pos. Item	Artikel Nr. Item no.	Pc.	Unit	Beschreibung Descripción	Description Description	Abm. Dim.	Norm Standard
						Drehmoment Torque	Schmierstoff Lubricant
2	5000085448	1	pc	Verschlusskappe Tapa de cierre	Nose cap Chape de fermeture		
3	5000077059	1	pc	Gehäuse Carcasa	Housing Carter		
4	5000029747	1	pc	Adapter Adaptador	Adaptor Adaptateur		
5	5000078715	4	pc	Rillenkugellager Rodamiento de bolas	Grooved ball bearing Roulement à billes		
6	5000029748	1	pc	Wellenseelenadapter Adaptador alma	Inner core adaptor Adaptateur arbre à		
7	5000077058	1	pc	Unwucht Masa excéntrica	Eccentric weight Balourd		
8	5000029778	2	pc	Wellendichtring Sello del eje	Shaft seal Bague d'étanchéité		
9	5000030715	1	pc	Abstandshülse Manguito distanciador	Distance sleeve Douille d'écartement		
12	5100045462	1	pc	Aufkleber Calcomania	Label Autocollant		

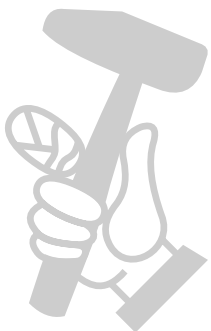

Flasche H 35S  
Head h 35s  
Capezote h 35s  
Aiguilles h 35s

M1500/230 EU



Pos. Item	Artikel Nr. Item no.	Pc.	Unit	Beschreibung Descripción	Description Description	Abm. Dim.	Norm Standard
						Drehmoment Torque	Schmierstoff Lubricant
2	5000085449	1	pc	Verschlusskappe Tapa de cierre	Nose cap Chape de fermeture		
3	5000080295	1	pc	Gehäuse Carcasa	Housing Carter		
4	5000029754	1	pc	Adapter Adaptador	Adaptor Adaptateur		
5	5000078716	4	pc	Rillenkugellager Rodamiento de bolas	Grooved ball bearing Roulement à billes		
6	5000029755	1	pc	Wellenseelenadapter Adaptador alma	Inner core adaptor Adaptateur arbre à		
7	5000080296	1	pc	Unwucht Masa excéntrica	Eccentric weight Balourd		
8	5000029781	2	pc	Wellendichtring Sello del eje	Shaft seal Bague d'étanchéité		
12	5100045462	1	pc	Aufkleber Calcomania	Label Autocollant		

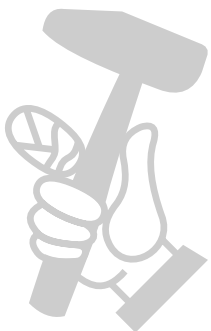

Flasche H 45S  
Head h 45s  
Capezote h 45s  
Aiguilles h 45s

M1500/230 EU

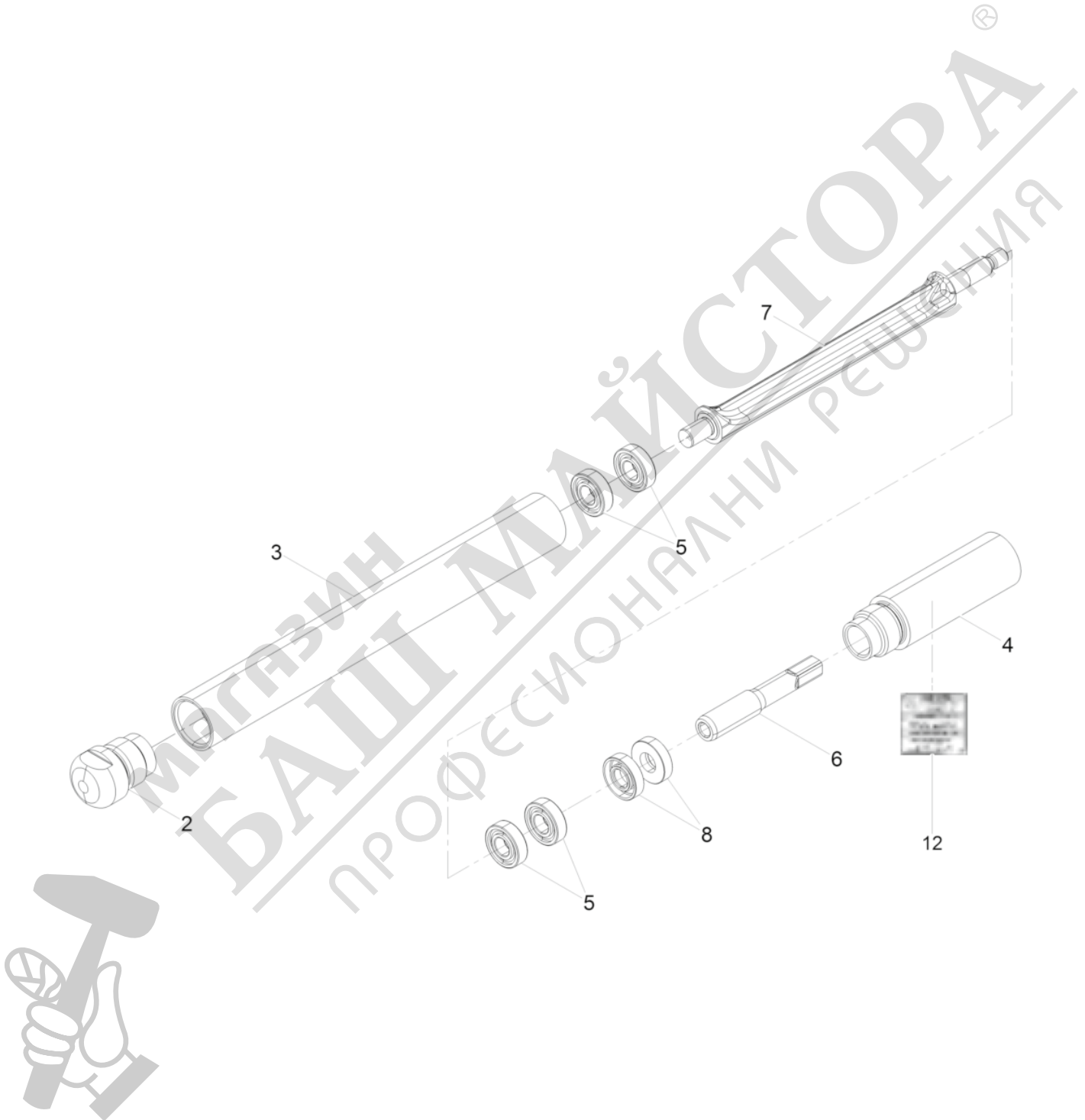



Pos. Item	Artikel Nr. Item no.	Pc.	Unit	Beschreibung Descripción	Description Description	Abm. Dim.	Norm Standard
						Drehmoment Torque	Schmierstoff Lubricant
2	5000085450	1	pc	Verschlusskappe Tapa de cierre	Nose cap Chape de fermeture		
3	5000080298	1	pc	Gehäuse Carcasa	Housing Carter		
4	5000029761	1	pc	Adapter Adaptador	Adaptor Adaptateur		
5	5000078717	4	pc	Rillenkugellager Rodamiento de bolas	Grooved ball bearing Roulement à billes		
6	5000029755	1	pc	Wellenseelenadapter Adaptador alma	Inner core adaptor Adaptateur arbre à		
7	5000080299	1	pc	Unwucht Masa excéntrica	Eccentric weight Balourd		
8	5000029784	2	pc	Wellendichtring Sello del eje	Shaft seal Bague d'étanchéité		
12	5100045462	1	pc	Aufkleber Calcomania	Label Autocollant		

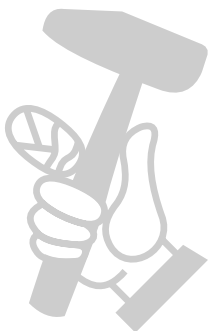

Flasche H 25HA  
Head h 25ha  
Capezote h 25ha  
Aiguilles h 25ha

M1500/230 EU



Pos. Item	Artikel Nr. Item no.	Pc.	Unit	Beschreibung Descripción	Description Description	Abm. Dim.	Norm Standard
						Drehmoment Torque	Schmierstoff Lubricant
1	5000205961	1	pc	Unwuchtwelle Eje de la masa excéntrica	Eccentric shaft Arbre portant l'excentrique		
2	5000205965	1	pc	Anschlussstück Conector	Connector Connexion		
3	5000206369	1	pc	Gehäuserohr Carcasa del vibrador	Vibrator head casing Chemise moteur		
4	5000212707	1	pc	Gehäuse Carcasa	Housing Enveloppe		
5	5000029748	1	pc	Wellenseelenadapter Adaptador alma	Inner core adaptor Adaptateur arbre à		
6	5000207215	4	pc	Rillenkugellager Rodamiento a bolas	Grooved ball bearing Roulement rainuré à billes		
7	5000205966	2	pc	Wellendichtring Anillo de retén radial	Rotary shaft seal Bague d'étanchéité		DIN3760
8	5000207216	2	pc	Federring Arandela elástica	Lock washer Rondelle de ressort		
9	5000207217	1	pc	Druckfeder Resorte de compresión	Compression spring Ressort de pression		
10	5000207936	1	pc	Buchse Buje	Bush Boîte		
15	5100045462	1	pc	Aufkleber Calcomania	Label Autocollant		

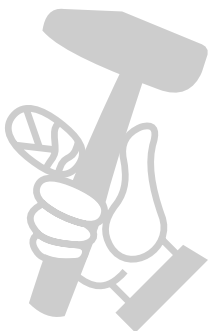

Flasche H 35HA  
Head h 35ha  
Capezote h 35ha  
Aiguilles h 35ha

M1500/230 EU



Pos. Item	Artikel Nr. Item no.	Pc.	Unit	Beschreibung Descripción	Description Description	Abm. Dim.	Norm Standard
						Drehmoment Torque	Schmierstoff Lubricant
1	5000204087	1	pc	Unwuchtwelle Eje de la masa excéntrica	Eccentric shaft Arbre portant l'excentrique		
2	5000205746	1	pc	Anschlussstück Conector	Connector Connexion		
3	5000211887	1	pc	Gehäuse Carcasa	Housing Enveloppe		
4	5000205747	2	pc	Abstandsscheibe Arandela distanciador	Distance washer Rondelle intermédiaire		
5	5000208490	1	pc	Wellenseelenadapter Adaptador alma	Inner core adaptor Adaptateur arbre à		
6	5000205759	4	pc	Rillenkugellager Rodamiento a bolas	Grooved ball bearing Roulement rainuré à billes		
7	5000208723	2	pc	Wellendichtring Empaque de aceite	Oil seal Joint d'huile	A 14x24x7	
9	5000205757	8	pc	Tellerfeder Resorte de platillo	Cup spring Ressort belleville		
15	5100045462	1	pc	Aufkleber Calcomania	Label Autocollant		

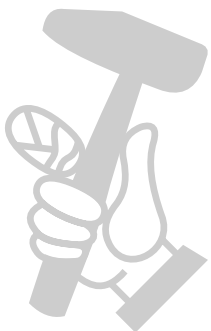

Flasche H 45HA  
Head h 45ha  
Capezote h 45ha  
Aiguilles h 45ha

M1500/230 EU



Pos. Item	Artikel Nr. Item no.	Pc.	Unit	Beschreibung Descripción	Description Description	Abm. Dim.	Norm Standard
						Drehmoment Torque	Schmierstoff Lubricant
1	5000204086	1	pc	Unwuchtwelle Eje de la masa excéntrica	Eccentric shaft Arbre portant l'excentrique		
2	5000204261	1	pc	Anschlussstück Conector	Connector Connexion		
3	5000211888	1	pc	Gehäuse Carcasa	Housing Enveloppe		
4	5000204260	2	pc	Abstandsscheibe Arandela distanciador	Distance washer Rondelle intermédiaire		
5	5000208491	1	pc	Wellenseelenadapter Adaptador alma	Inner core adaptor Adaptateur arbre à		
6	5000205762	4	pc	Rillenkugellager Rodamiento a bolas	Grooved ball bearing Roulement rainuré à billes		
7	5000208723	2	pc	Wellendichtring Empaque de aceite	Oil seal Joint d'huile	A 14x24x7	
9	5000105844	8	pc	Tellerfeder Resorte de platillo	Cup spring Ressort belleville		
15	5100045462	1	pc	Aufkleber Calcomania	Label Autocollant		

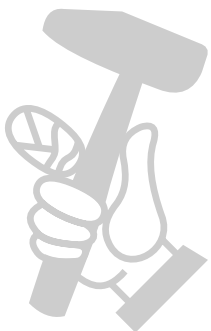

Flasche H 50HA  
Head h 50ha  
Capezote h 50ha  
Aiguilles h 50ha

M1500/230 EU





Pos. Item	Artikel Nr. Item no.	Pc.	Unit	Beschreibung Descripción	Description Description	Abm. Dim.	Norm Standard
						Drehmoment Torque	Schmierstoff Lubricant
1	5000204088	1	pc	Unwuchtwelle Eje de la masa excéntrica	Eccentric shaft Arbre portant l'excentrique		
2	5000212701	1	pc	Anschlussstück Conector	Connector Connexion		
3	5000211889	1	pc	Gehäuse Carcasa	Housing Enveloppe		
4	5000204260	2	pc	Abstandsscheibe Arandela distanciador	Distance washer Rondelle intermédiaire		
5	5000208491	1	pc	Wellenseelenadapter Adaptador alma	Inner core adaptor Adaptateur arbre à		
6	5000205763	2	pc	Rillenkugellager Rodamiento a bolas	Grooved ball bearing Roulement rainuré à billes		
7	5000208723	2	pc	Wellendichtring Empaque de aceite	Oil seal Joint d'huile	A 14x24x7	
9	5000206287	8	pc	Tellerfeder Resorte de platillo	Cup spring Ressort belleville		
11	5000205762	2	pc	Rillenkugellager Rodamiento a bolas	Grooved ball bearing Roulement rainuré à billes		
12	5000105844	2	pc	Tellerfeder Resorte de platillo	Cup spring Ressort belleville		
15	5100045462	1	pc	Aufkleber Calcomania	Label Autocollant		

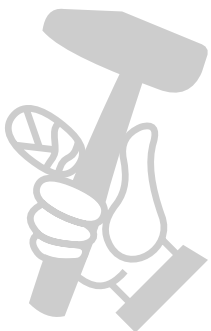



Pos. Item	Artikel Nr. Item no.	Pc.	Unit	Beschreibung Descripción	Description Description	Abm. Dim.	Norm Standard
						Drehmoment Torque	Schmierstoff Lubricant
1	5100010882	1	pc	Schultergurt Correa	Shoulder belt Ruban		

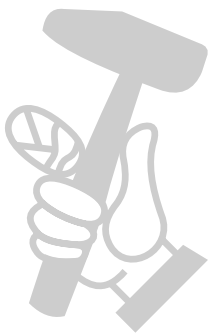

МАГАЗИН МАЙСТОРА  
БАШ МАЙСТОРА  
ПРОФЕСИОНАЛНИ РЕШЕНИЯ



Pos. Item	Artikel Nr. Item no.	Pc.	Unit	Beschreibung Descripción	Description Description	Abm. Dim.	Norm Standard
						Drehmoment Torque	Schmierstoff Lubricant
1	5100069809	1	pc	Biegewellenseele Kpl. Alma cpl.	Inner core cpl. Arbre à transmission		
2	5100069810	1	pc	Schutzschlauch Kpl. Manguera de protección cpl.	Protective hose cpl. Gaine de protection cpl.		
3	5100069828	1	pc	Kupplung Embrague	Coupling Embrayage		
4	5100069826	1	pc	Anschlussstück Motor Conector motor	Connector engine Connexion moteur		
5	5100069825	1	pc	Scheibe Disco	Disc Disque		
6	5100069807	1	pc	Anschlussstück Flasche Conector capezote	Connector head Connexion aiguilles		
7	5100066410	1	pc	Biegewelle SM 1S Ejes flexibles sm 1s	Flex shafts sm 1s Transmission flexible sm 1s		

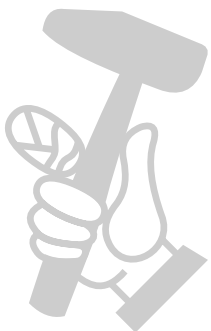

МАГАЗИН МАЙСТОР  
 БАШ МАЙСТОР  
 ПРОФЕСИОНАЛНИ РЕШЕНИЯ



Pos. Item	Artikel Nr. Item no.	Pc.	Unit	Beschreibung Descripción	Description Description	Abm. Dim.	Norm Standard
						Drehmoment Torque	Schmierstoff Lubricant
1	5100069811	1	pc	Biegewellenseele Kpl. Alma cpl.	Inner core cpl. Arbre à transmission		
2	5100069812	1	pc	Schutzschlauch Kpl. Manguera de protección cpl.	Protective hose cpl. Gaine de protection cpl.		
3	5100069828	1	pc	Kupplung Embrague	Coupling Embrayage		
4	5100069826	1	pc	Anschlussstück Motor Conector motor	Connector engine Connexion moteur		
5	5100069825	1	pc	Scheibe Disco	Disc Disque		
6	5100069807	1	pc	Anschlussstück Flasche Conector capezote	Connector head Connexion aiguilles		
7	5100066411	1	pc	Biegewelle SM 2S Ejes flexibles sm 2s	Flex shafts sm 2s Tansmission flexible sm2s		

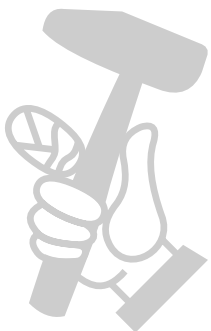

МАГАЗИН МАЙСТОР  
БАШ МАЙСТОР  
ПРОФЕСИОНАЛНИ РЕШЕНИЯ

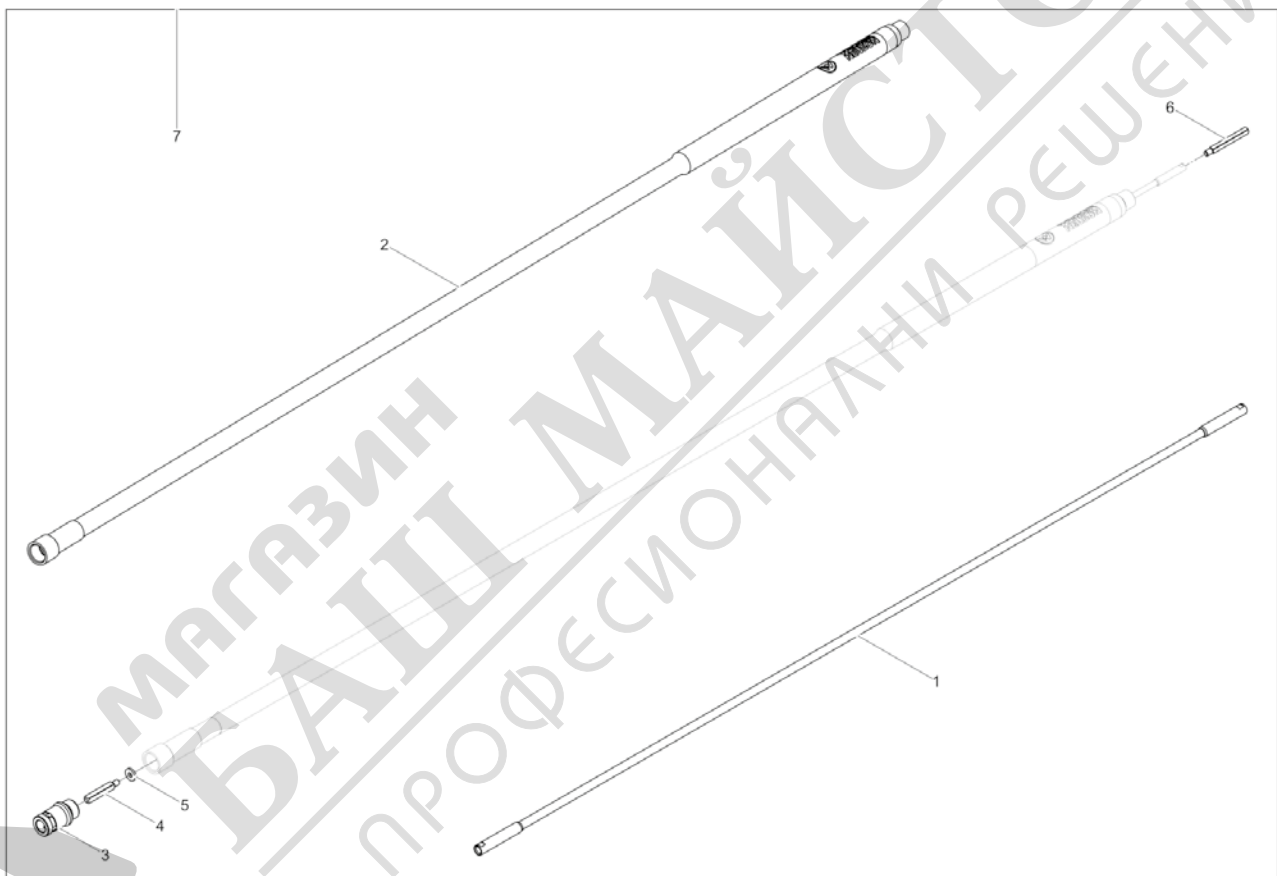



Pos. Item	Artikel Nr. Item no.	Pc.	Unit	Beschreibung Descripción	Description Description	Abm. Dim.	Norm Standard
						Drehmoment Torque	Schmierstoff Lubricant
1	5100069813	1	pc	Biegewellenseele Kpl. Alma cpl.	Inner core cpl. Arbre à transmission		
2	5100069814	1	pc	Schutzschlauch Kpl. Manguera de protección cpl.	Protective hose cpl. Gaine de protection cpl.		
3	5100069828	1	pc	Kupplung Embrague	Coupling Embrayage		
4	5100069826	1	pc	Anschlussstück Motor Conector motor	Connector engine Connexion moteur		
5	5100069825	1	pc	Scheibe Disco	Disc Disque		
6	5100069807	1	pc	Anschlussstück Flasche Conector capezote	Connector head Connexion aiguilles		
7	5100066412	1	pc	Biegewelle SM 3S Ejes flexibles sm 3s	Flex shafts sm 3s Transmission flexible sm 3s		

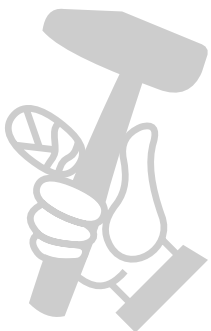

МАГАЗИН МАЙСТОР  
БАШ МАЙСТОР  
ПРОФЕСИОНАЛНИ РЕШЕНИЯ



Pos. Item	Artikel Nr. Item no.	Pc.	Unit	Beschreibung Descripción	Description Description	Abm. Dim.	Norm Standard
						Drehmoment Torque	Schmierstoff Lubricant
1	5100069815	1	pc	Biegewellenseele Kpl. Alma cpl.	Inner core cpl. Arbre à transmission		
2	5100069817	1	pc	Schutzschlauch Kpl. Manguera de protección cpl.	Protective hose cpl. Gaine de protection cpl.		
3	5100069828	1	pc	Kupplung Embrague	Coupling Embrayage		
4	5100069826	1	pc	Anschlussstück Motor Conector motor	Connector engine Connexion moteur		
5	5100069825	1	pc	Scheibe Disco	Disc Disque		
6	5100069807	1	pc	Anschlussstück Flasche Conector capezote	Connector head Connexion aiguilles		
7	5100066413	1	pc	Biegewelle SM 4S Ejes flexibles sm 4s	Flex shafts sm 4s Transmission flexible sm 4s		

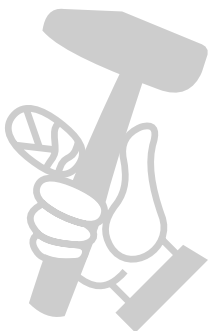

МАГАЗИН МАЙСТОР  
БАШ МАЙСТОР  
ПРОФЕСИОНАЛНИ РЕШЕНИЯ



Pos. Item	Artikel Nr. Item no.	Pc.	Unit	Beschreibung Descripción	Description Description	Abm. Dim.	Norm Standard
						Drehmoment Torque	Schmierstoff Lubricant
1	5100069818	1	pc	Biegewellenseele Kpl. Alma cpl.	Inner core cpl. Arbre à transmission		
2	5100069819	1	pc	Schutzschlauch Kpl. Manguera de protección cpl.	Protective hose cpl. Gaine de protection cpl.		
3	5100069828	1	pc	Kupplung Embrague	Coupling Embrayage		
4	5100069826	1	pc	Anschlussstück Motor Conector motor	Connector engine Connexion moteur		
5	5100069825	1	pc	Scheibe Disco	Disc Disque		
6	5100069807	1	pc	Anschlussstück Flasche Conector capezote	Connector head Connexion aiguilles		
7	5100066414	1	pc	Biegewelle SM 5S Ejes flexibles sm 5s	Flex shafts sm 5s Transmission flexible sm 5s		

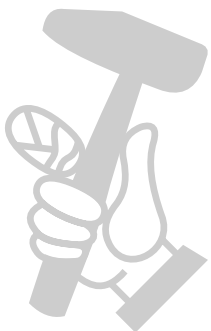

МАГАЗИН МАЙСТОР  
БАШ МАЙСТОР  
ПРОФЕСИОНАЛНИ РЕШЕНИЯ



Pos. Item	Artikel Nr. Item no.	Pc.	Unit	Beschreibung Descripción	Description Description	Abm. Dim.	Norm Standard
						Drehmoment Torque	Schmierstoff Lubricant
1	5100069821	1	pc	Biegewellenseele Kpl. Alma cpl.	Inner core cpl. Arbre à transmission		
2	5100069822	1	pc	Schutzschlauch Kpl. Manguera de protección cpl.	Protective hose cpl. Gaine de protection cpl.		
3	5100069828	1	pc	Kupplung Embrague	Coupling Embrayage		
4	5100069826	1	pc	Anschlussstück Motor Conector motor	Connector engine Connexion moteur		
5	5100069825	1	pc	Scheibe Disco	Disc Disque		
6	5100069807	1	pc	Anschlussstück Flasche Conector capezote	Connector head Connexion aiguilles		
7	5100066415	1	pc	Biegewelle SM 7S Ejes flexibles sm 7s	Flex shafts sm 7s Transmission flexible sm 7s		

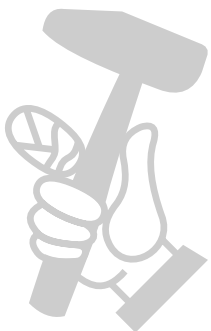





Pos. Item	Artikel Nr. Item no.	Pc.	Unit	Beschreibung Descripción	Description Description	Abm. Dim.	Norm Standard
						Drehmoment Torque	Schmierstoff Lubricant
1	5100069823	1	pc	Biegewellenseele Kpl. Alma cpl.	Inner core cpl. Arbre à transmission		
2	5100069824	1	pc	Schutzschlauch Kpl. Manguera de protección cpl.	Protective hose cpl. Gaine de protection cpl.		
3	5100069828	1	pc	Kupplung Embrague	Coupling Embrayage		
4	5100069826	1	pc	Anschlussstück Motor Conector motor	Connector engine Connexion moteur		
5	5100069825	1	pc	Scheibe Disco	Disc Disque		
6	5100069807	1	pc	Anschlussstück Flasche Conector capezote	Connector head Connexion aiguilles		
7	5100066416	1	pc	Biegewelle SM 9S Ejes flexibles sm 9s	Flex shafts sm 9s Transmission flexible sm 9s		

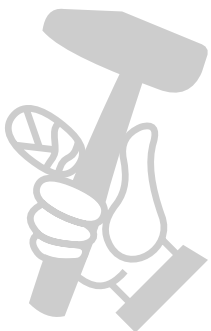

МАГАЗИН МАЙСТОР  
 БАШ МАЙСТОР  
 ПРОФЕСИОНАЛНИ РЕШЕНИЯ



Pos. Item	Artikel Nr. Item no.	Pc.	Unit	Beschreibung Descripción	Description Description	Abm. Dim.	Norm Standard
						Drehmoment Torque	Schmierstoff Lubricant
1	5100069837	1	pc	Biegewellenseele Kpl. Alma cpl.	Inner core cpl. Arbre à transmission		
2	5100069806	1	pc	Schutzschlauch Kpl. Manguera de protección cpl.	Protective hose cpl. Gaine de protection cpl.		
3	5100069828	1	pc	Kupplung Embrague	Coupling Embrayage		
4	5100069826	1	pc	Anschlussstück Motor Conector motor	Connector engine Connexion moteur		
5	5100069825	1	pc	Scheibe Disco	Disc Disque		
6	5100069807	1	pc	Anschlussstück Flasche Conector capezote	Connector head Connexion aiguilles		
7	5100069202	1	pc	Biegewelle SM 0S Ejes flexibles sm 0s	Flex shafts sm 0s Transmission flexible sm 0s		

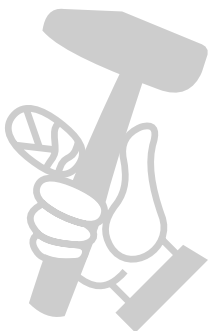

МАГАЗИН МАЙСТОР  
БАШ МАЙСТОР  
ПРОФЕСИОНАЛНИ РЕШЕНИЯ



Pos. Item	Artikel Nr. Item no.	Pc.	Unit	Beschreibung Descripción	Description Description	Abm. Dim.	Norm Standard
						Drehmoment Torque	Schmierstoff Lubricant
1	5100069805	1	pc	Biegewellenseele Kpl. Alma cpl.	Inner core cpl. Arbre à transmission		
2	5100069808	1	pc	Schutzschlauch Kpl. Manguera de protección cpl.	Protective hose cpl. Gaine de protection cpl.		
3	5100069820	1	pc	Anschlussstück Flasche Conector capezote	Connector head Connexion aiguilles		
4	5100069825	1	pc	Scheibe Disco	Disc Disque		
5	5100069826	1	pc	Anschlussstück Motor Conector motor	Connector engine Connexion moteur		
6	5100069828	1	pc	Kupplung Embrague	Coupling Embrayage		
7	5100069203	1	pc	Biegewelle SM 1E Ejes flexibles sm 1e	Flex shafts sm 1e Transmission flexible sm 1e		

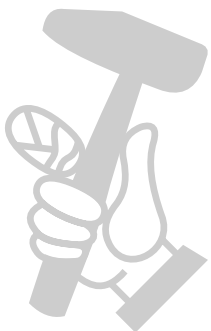

МАГАЗИН МАЙСТОР  
БАШ МАЙСТОР  
ПРОФЕСИОНАЛНИ РЕШЕНИЯ

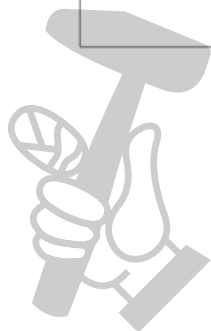

Pos. Item	Artikel Nr. Item no.	Pc.	Unit	Beschreibung Descripción	Description Description	Abm. Dim.	Norm Standard
						Drehmoment Torque	Schmierstoff Lubricant
1	5100069829	1	pc	Biegewellenseele Kpl. Alma cpl.	Inner core cpl. Arbre à transmission		
2	5100069830	1	pc	Schutzschlauch Kpl. Manguera de protección cpl.	Protective hose cpl. Gaine de protection cpl.		
3	5100069820	1	pc	Anschlussstück Flasche Conector capezote	Connector head Connexion aiguilles		
4	5100069825	1	pc	Scheibe Disco	Disc Disque		
5	5100069826	1	pc	Anschlussstück Motor Conector motor	Connector engine Connexion moteur		
6	5100069828	1	pc	Kupplung Embrague	Coupling Embrayage		
7	5100069204	1	pc	Biegewelle SM 2E Ejes flexibles sm 2e	Flex shafts sm 2e Transmission flexible sm 2e		

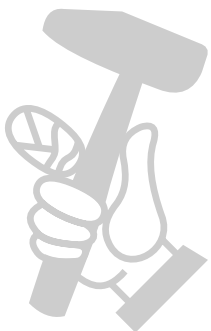

МАГАЗИН МАЙСТОР  
БАШ МАЙСТОР  
ПРОФЕСИОНАЛНИ РЕШЕНИЯ

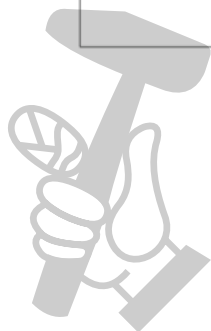



Pos. Item	Artikel Nr. Item no.	Pc.	Unit	Beschreibung Descripción	Description Description	Abm. Dim.	Norm Standard
						Drehmoment Torque	Schmierstoff Lubricant
1	5100069831	1	pc	Biegewellenseele Kpl. Alma cpl.	Inner core cpl. Arbre à transmission		
2	5100069816	1	pc	Schutzschlauch Kpl. Manguera de protección cpl.	Protective hose cpl. Gaine de protection cpl.		
3	5100069820	1	pc	Anschlussstück Flasche Conector capezote	Connector head Connexion aiguilles		
4	5100069825	1	pc	Scheibe Disco	Disc Disque		
5	5100069826	1	pc	Anschlussstück Motor Conector motor	Connector engine Connexion moteur		
6	5100069828	1	pc	Kupplung Embrague	Coupling Embrayage		
7	5100069205	1	pc	Biegewelle SM 3E Ejes flexibles sm 3e	Flex shafts sm 3e Transmission flexible sm 3e		

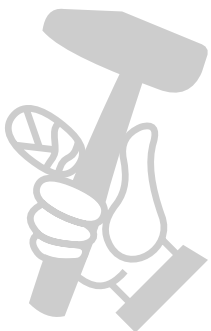

МАГАЗИН МАЙСТОР  
БАШ МАЙСТОР  
ПРОФЕСИОНАЛНИ РЕШЕНИЯ

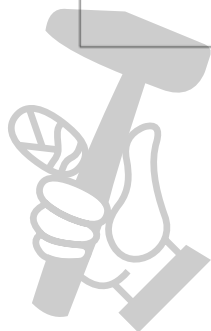

Pos. Item	Artikel Nr. Item no.	Pc.	Unit	Beschreibung Descripción	Description Description	Abm. Dim.	Norm Standard
						Drehmoment Torque	Schmierstoff Lubricant
1	5100069827	1	pc	Biegewellenseele Kpl. Alma cpl.	Inner core cpl. Arbre à transmission		
2	5100069832	1	pc	Schutzschlauch Kpl. Manguera de protección cpl.	Protective hose cpl. Gaine de protection cpl.		
3	5100069820	1	pc	Anschlussstück Flasche Conector capezote	Connector head Connexion aiguilles		
4	5100069825	1	pc	Scheibe Disco	Disc Disque		
5	5100069826	1	pc	Anschlussstück Motor Conector motor	Connector engine Connexion moteur		
6	5100069828	1	pc	Kupplung Embrague	Coupling Embrayage		
7	5100069206	1	pc	Biegewelle SM 4E Ejes flexibles sm 4e	Flex shafts sm 4e Transmission flexible sm 4e		

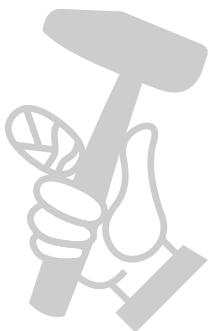

МАГАЗИН МАЙСТОР  
БАШ МАЙСТОР  
ПРОФЕСИОНАЛНИ РЕШЕНИЯ

Biegewelle SM 5E  
Flex shafts sm 5e  
Ejes flexibles sm 5e  
Transmission flexible sm 5e

M1500/230 EU

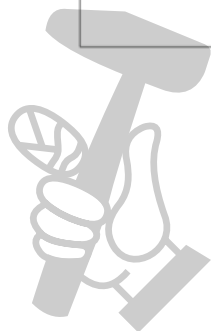

Pos. Item	Artikel Nr. Item no.	Pc.	Unit	Beschreibung Descripción	Description Description	Abm. Dim.	Norm Standard
						Drehmoment Torque	Schmierstoff Lubricant
1	5100069833	1	pc	Biegewellenseele Kpl. Alma cpl.	Inner core cpl. Arbre à transmission		
2	5100069834	1	pc	Schutzschlauch Kpl. Manguera de protección cpl.	Protective hose cpl. Gaine de protection cpl.		
3	5100069820	1	pc	Anschlussstück Flasche Conector capezote	Connector head Connexion aiguilles		
4	5100069825	1	pc	Scheibe Disco	Disc Disque		
5	5100069826	1	pc	Anschlussstück Motor Conector motor	Connector engine Connexion moteur		
6	5100069828	1	pc	Kupplung Embrague	Coupling Embrayage		
7	5100069207	1	pc	Biegewelle SM 5E Ejes flexibles sm 5e	Flex shafts sm 5e Transmission flexible sm 5e		

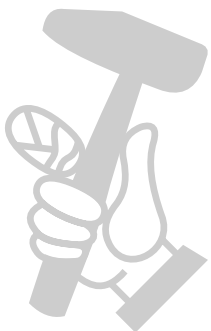

МАГАЗИН МАЙСТОР  
БАШ МАЙСТОР  
ПРОФЕСИОНАЛНИ РЕШЕНИЯ

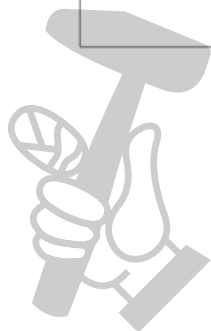

Pos. Item	Artikel Nr. Item no.	Pc.	Unit	Beschreibung Descripción	Description Description	Abm. Dim.	Norm Standard
						Drehmoment Torque	Schmierstoff Lubricant
1	5100069835	1	pc	Biegewellenseele Kpl. Alma cpl.	Inner core cpl. Arbre à transmission		
2	5100069836	1	pc	Schutzschlauch Kpl. Manguera de protección cpl.	Protective hose cpl. Gaine de protection cpl.		
3	5100069820	1	pc	Anschlussstück Flasche Conector capezote	Connector head Connexion aiguilles		
4	5100069825	1	pc	Scheibe Disco	Disc Disque		
5	5100069826	1	pc	Anschlussstück Motor Conector motor	Connector engine Connexion moteur		
6	5100069828	1	pc	Kupplung Embrague	Coupling Embrayage		
7	5100069208	1	pc	Biegewelle SM 7E Ejes flexibles sm 7e	Flex shafts sm 7e Transmission flexible sm 7e		

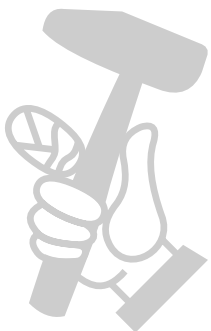

МАГАЗИН МАЙСТОР  
БАШ МАЙСТОР  
ПРОФЕСИОНАЛНИ РЕШЕНИЯ

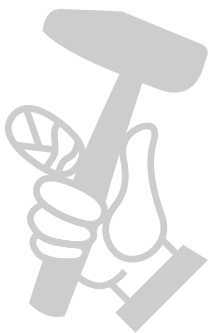

МАГАЗИН  
БАШ МАЙСТОРА®  
ПРОФЕСИОНАЛНИ РЕШЕНИЯ





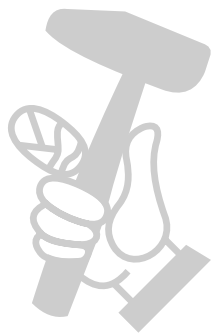

МАГАЗИН  
**БАШ МАЙСТОРА**<sup>®</sup>  
ПРОФЕСИОНАЛНИ РЕШЕНИЯ



**WACKER  
NEUSON**

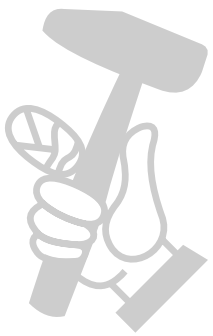

МАГАЗИН  
**БАШ МАЙСТОРА**<sup>®</sup>  
ПРОФЕСИОНАЛНИ РЕШЕНИЯ