

# DEWALT®

## XR LI-ION

МАГАЗИН  
БАШ МАЙСТОРА  
ПРОФЕСИОНАЛНИ РЕШЕНИЯ



Fig. A

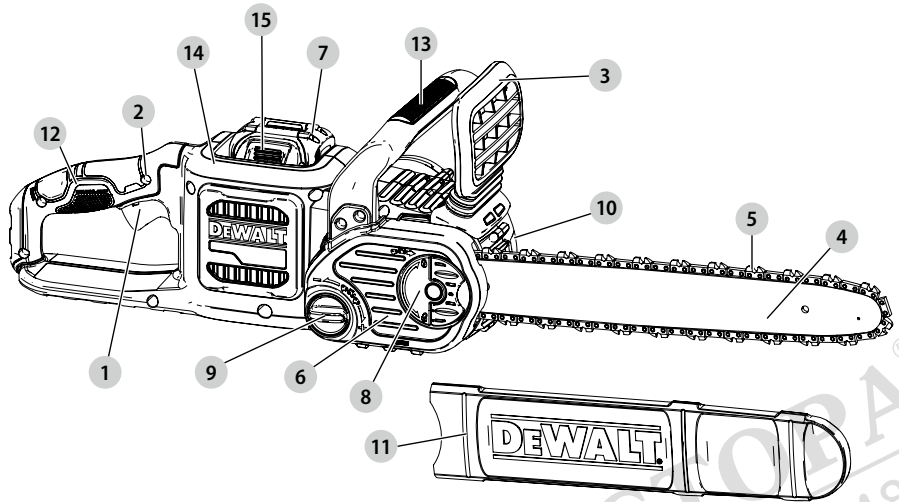

Fig. B

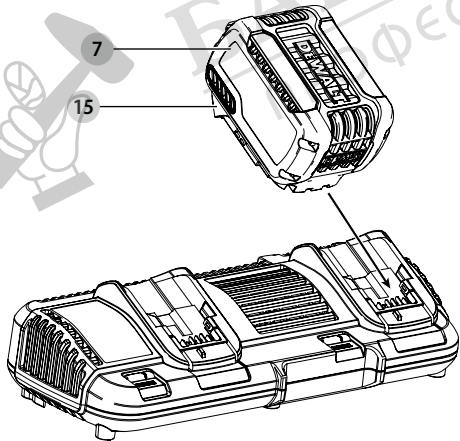

Fig. C

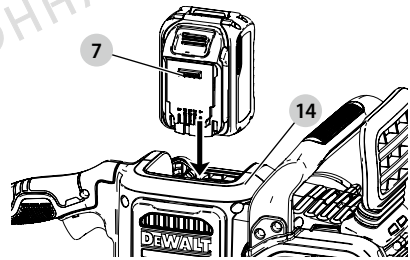

Fig. D

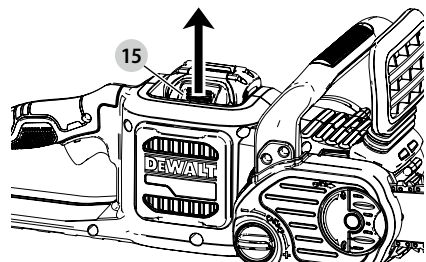

Fig. E

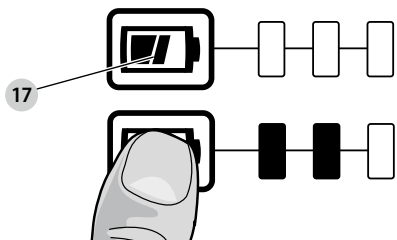

Fig. F

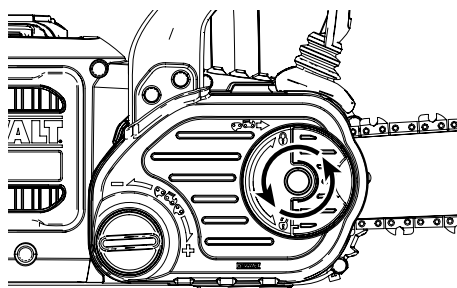

Fig. G

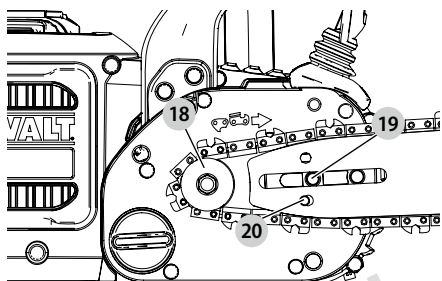

Fig. H

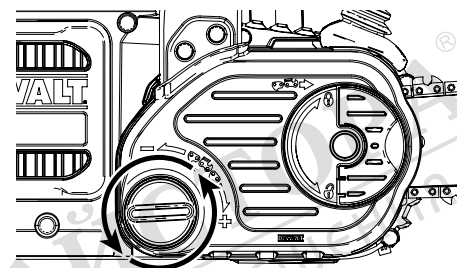

Fig. I

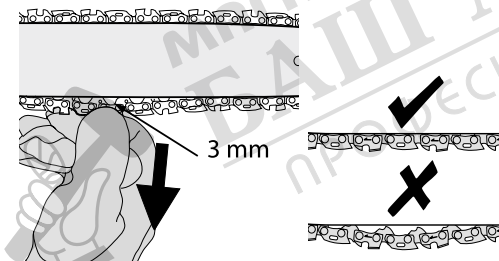

Fig. J

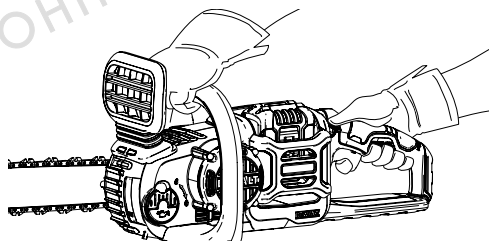

Fig. K

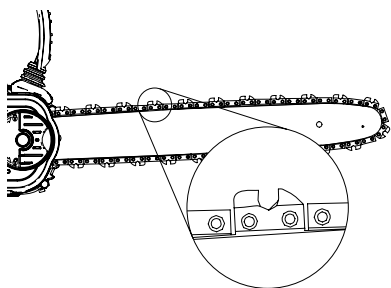

Fig. L

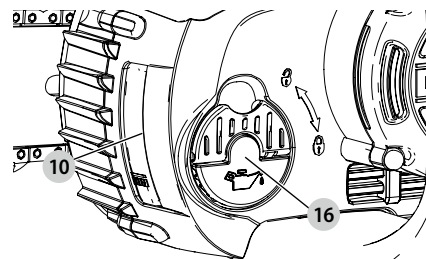

Fig. M

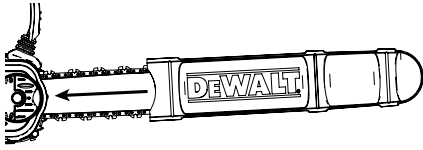

Fig. N

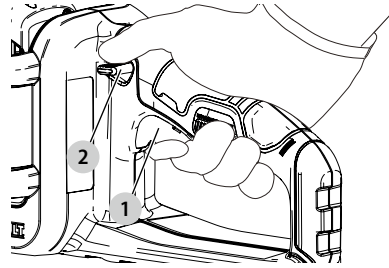

Fig. O

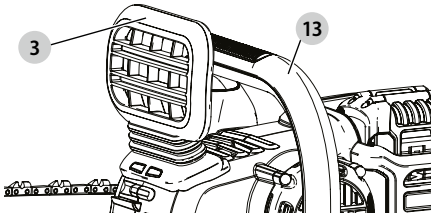

Fig. P

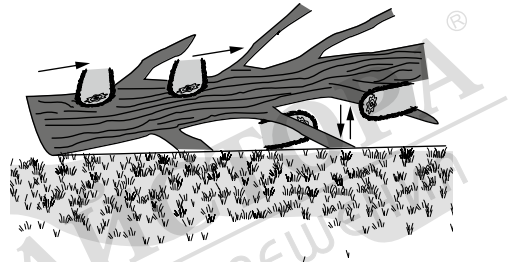

Fig. Q

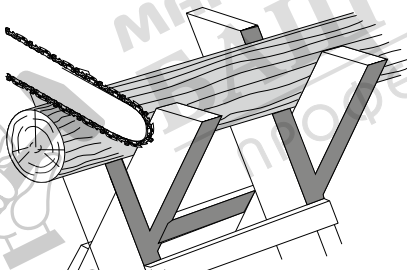

Fig. R

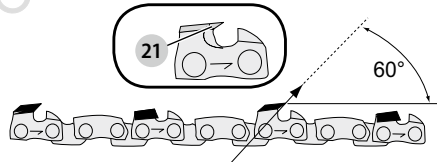

Fig. S

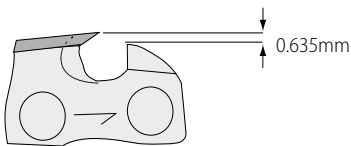
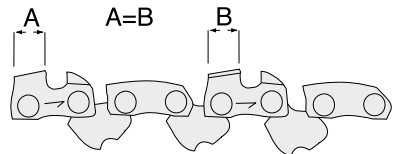

Fig. T



# 54V CHAINSAW

## DCM575

### Congratulations!

You have chosen a DeWALT tool. Years of experience, thorough product development and innovation make DeWALT one of the most reliable partners for professional power tool users.

### Technical Data

	DCM575	
Voltage	V <sub>DC</sub>	54
UK & Ireland	V <sub>DC</sub>	54
Battery type		Li-Ion
Bar Length	cm	40
Maximum Chain Speed (no-load)	m/s	15
Maximum Cutting Length	cm	40
Oil Capacity	ml	115
Weight (without battery pack)	kg	4.4

Noise values and vibration values (triax vector sum) according to EN60745-2-13:2009+A1:2010:

L <sub>PA</sub> (emission sound pressure level)	dB(A)	80.5
L <sub>WA</sub> (sound power level)	dB(A)	100.5
K (uncertainty for the given sound level)	dB(A)	3
Vibration emission value a <sub>h</sub> =		
	m/s <sup>2</sup>	3.5
Uncertainty K =		
	m/s <sup>2</sup>	1.5

The vibration emission level given in this information sheet has been measured in accordance with a standardised test given in EN60745 and may be used to compare one tool with another. It may be used for a preliminary assessment of exposure.



**WARNING:** The declared vibration emission level represents the main applications of the tool. However if the tool is used for different applications, with different accessories or poorly maintained, the vibration emission may differ. This may significantly increase the exposure level over the total working period.

An estimation of the level of exposure to vibration should also take into account the times when the tool is switched off or when it is running but not actually doing the job. This may significantly reduce the exposure level over the total working period.

Identify additional safety measures to protect the operator from the effects of vibration such as: maintain the tool and the accessories, keep the hands warm, organisation of work patterns.

### EC-Declaration of Conformity

#### Machinery Directive



#### 54V Chainsaw

#### DCM575

DeWALT declares that these products described under **Technical Data** are in compliance with:

2006/42/EC, EN60745-1:2009+A11:2010, EN60745-2-13:2009+A1:2010.

2000/14/EC , Annex V DEKRA Certification B.V., Meander 1051 / P.O. Box 5185 6825 MJ ARNHEM / 6802 ED

ARNHEM

Netherlands

Notified Body ID No.: 0344

L<sub>PA</sub> (measured sound pressure level) 80.5 dB(A)  
uncertainty (K) = 2,0 dB (A)

L<sub>WA</sub> (guaranteed sound power) 104 dB(A)

These products also comply with Directive 2014/30/EU and 2011/65/EU. For more information, please contact DeWALT at the following address or refer to the back of the manual.

The undersigned is responsible for compilation of the technical file and makes this declaration on behalf of DeWALT.

Markus Rompel  
Director Engineering  
DeWALT, Richard-Klinger-Straße 11,  
D-65510, Idstein, Germany  
30.10.2018



**WARNING:** To reduce the risk of injury, read the instruction manual.

### Definitions: Safety Guidelines

The definitions below describe the level of severity for each signal word. Please read the manual and pay attention to these symbols.



**DANGER:** Indicates an imminently hazardous situation which, if not avoided, **will** result in **death or serious injury**.



**WARNING:** Indicates a potentially hazardous situation which, if not avoided, **could** result in **death or serious injury**.



**CAUTION:** Indicates a potentially hazardous situation which, if not avoided, **may** result in **minor or moderate injury**.

**NOTICE:** Indicates a practice **not related to personal injury** which, if not avoided, **may** result in **property damage**.

Batteries				Chargers/Charge Times (Minutes)						
Cat #	V <sub>DC</sub>	Ah	Weight kg	DCB107	DCB113	DCB115	DCB118	DCB132	DCB119	DCB413
DCB547	18/54	9.0/3.0	1.25	420	220	140	85	140	X	X
DCB546	18/54	6.0/2.0	1.05	270	140	90	60	90	X	X
DCB497	36	7.5	1.92	X	X	X	X	X	X	150
DCB496	36	6.0	1.88	X	X	X	X	X	X	120
DCB181	18	1.5	0.35	70	35	22	22	22	45	X
DCB182	18	4.0	0.61	185	100	60	60	60	120	X
DCB183/B	18	2.0	0.40	90	50	30	30	30	60	X
DCB184/B	18	5.0	0.62	240	120	75	75	75	150	X
DCB185	18	1.3	0.35	60	30	22	22	22	X	X



Denotes risk of electric shock.



Denotes risk of fire.

## General Power Tool Safety Warnings



**WARNING: Read all safety warnings and all instructions.** Failure to follow the warnings and instructions may result in electric shock, fire and/or serious injury.

## SAVE ALL WARNINGS AND INSTRUCTIONS FOR FUTURE REFERENCE

The term "power tool" in the warnings refers to your mains-operated (corded) power tool or battery-operated (cordless) power tool.

### 1) Work area safety

- Keep work area clean and well lit.** Cluttered or dark areas invite accidents.
- Do not operate power tools in explosive atmospheres, such as in the presence of flammable liquids, gases or dust.** Power tools create sparks which may ignite the dust or fumes.
- Keep children and bystanders away while operating a power tool.** Distractions can cause you to lose control.

### 2) Electrical safety

- Power tool plugs must match the outlet. Never modify the plug in any way. Do not use any adapter plugs with earthed (grounded) power tools.** Unmodified plugs and matching outlets will reduce risk of electric shock.
- Avoid body contact with earthed or grounded surfaces such as pipes, radiators, ranges and refrigerators.** There is an increased risk of electric shock if your body is earthed or grounded.
- Do not expose power tools to rain or wet conditions.** Water entering a power tool will increase the risk of electric shock.

- Do not abuse the cord. Never use the cord for carrying, pulling or unplugging the power tool. Keep cord away from heat, oil, sharp edges or moving parts.** Damaged or entangled cords increase the risk of electric shock.
- When operating a power tool outdoors, use an extension cord suitable for outdoor use.** Use of a cord suitable for outdoor use reduces the risk of electric shock.
- If operating a power tool in a damp location is unavoidable, use a residual current device (RCD) protected supply.** Use of an RCD reduces the risk of electric shock.

### 3) Personal safety

- Stay alert, watch what you are doing and use common sense when operating a power tool. Do not use a power tool while you are tired or under the influence of drugs, alcohol or medication.** A moment of inattention while operating power tools may result in serious personal injury.
- Use personal protective equipment. Always wear eye protection.** Protective equipment such as dust mask, non-skid safety shoes, hard hat, or hearing protection used for appropriate conditions will reduce personal injuries.
- Prevent unintentional starting. Ensure the switch is in the off position before connecting to power source and/or battery pack, picking up or carrying the tool.** Carrying power tools with your finger on the switch or energising power tools that have the switch on invites accidents.
- Remove any adjusting key or wrench before turning the power tool on.** A wrench or a key left attached to a rotating part of the power tool may result in personal injury.
- Do not overreach. Keep proper footing and balance at all times.** This enables better control of the power tool in unexpected situations.
- Dress properly. Do not wear loose clothing or jewellery. Keep your hair, clothing and gloves away from moving parts.** Loose clothes, jewellery or long hair can be caught in moving parts.

- g) *If devices are provided for the connection of dust extraction and collection facilities, ensure these are connected and properly used. Use of dust collection can reduce dust-related hazards.*

#### 4) Power tool use and care

- a) **Do not force the power tool. Use the correct power tool for your application.** *The correct power tool will do the job better and safer at the rate for which it was designed.*
- b) **Do not use the power tool if the switch does not turn it on and off.** *Any power tool that cannot be controlled with the switch is dangerous and must be repaired.*
- c) **Disconnect the plug from the power source and/or the battery pack from the power tool before making any adjustments, changing accessories, or storing power tools.** *Such preventive safety measures reduce the risk of starting the power tool accidentally.*
- d) **Store idle power tools out of the reach of children and do not allow persons unfamiliar with the power tool or these instructions to operate the power tool.** *Power tools are dangerous in the hands of untrained users.*
- e) **Maintain power tools. Check for misalignment or binding of moving parts, breakage of parts and any other condition that may affect the power tool's operation. If damaged, have the power tool repaired before use.** *Many accidents are caused by poorly maintained power tools.*
- f) **Keep cutting tools sharp and clean.** *Properly maintained cutting tools with sharp cutting edges are less likely to bind and are easier to control.*
- g) **Use the power tool, accessories and tool bits etc., in accordance with these instructions taking into account the working conditions and the work to be performed.** *Use of the power tool for operations different from those intended could result in a hazardous situation.*

#### 5) Battery tool use and care

- a) **Recharge only with the charger specified by the manufacturer.** *A charger that is suitable for one type of battery pack may create a risk of fire when used with another battery pack.*
- b) **Use power tools only with specifically designated battery packs.** *Use of any other battery packs may create a risk of injury and fire.*
- c) **When battery pack is not in use, keep it away from other metal objects like paper clips, coins, keys, nails, screws or other small metal objects that can make a connection from one terminal to another.** *Shorting the battery terminals together may cause burns or a fire.*
- d) **Under abusive conditions, liquid may be ejected from the battery; avoid contact. If contact accidentally occurs, flush with water. If liquid contacts eyes, additionally seek medical help. Liquid ejected from the battery may cause irritation or burns.**

#### 6) Service

- a) **Have your power tool serviced by a qualified repair person using only identical replacement parts.** *This will ensure that the safety of the power tool is maintained.*

#### Additional Chainsaw Safety Warnings



**WARNING: Additional safety warnings for chainsaws.**

- **Keep all parts of the body away from the saw chain when the chain saw is operating. Before you start the chain saw, make sure the saw chain is not contacting anything.** *A moment of inattention while operating chain saws may cause entanglement of your clothing or body with the saw chain.*
- **Always hold the chain saw with your right hand on the rear handle and your left hand on the front handle.** *Holding the chain saw with a reversed hand configuration increases the risk of personal injury and should never be done.*
- **Hold the power tool by insulated gripping surfaces only, because the saw chain may contact hidden wiring.** *Saw chains contacting a "live" wire may make exposed metal parts of the power tool "live" and could give the operator an electric shock.*
- **Wear safety glasses and hearing protection. Further protective equipment for head, hands, legs and feet is recommended.** *Adequate protective clothing will reduce personal injury by flying debris or accidental contact with the saw chain.*
- **Do not operate a chain saw in a tree.** *Operation of a chain saw while up in a tree may result in personal injury.*
- **Always keep proper footing and operate the chain saw only when standing on fixed, secure and level surface.** *Slippery or unstable surfaces such as ladders may cause a loss of balance or control of the chain saw.*
- **When cutting a limb that is under tension be alert for spring back.** *When the tension in the wood fibers is released the spring loaded limb may strike the operator and/or throw the chain saw out of control.*
- **Use extreme caution when cutting brush and saplings.** *The slender material may catch the saw chain and be whipped toward you or pull you off balance.*
- **Carry the chain saw by the front handle with the chain saw switched off and away from your body. When transporting or storing the chain saw always fit the guide bar cover.** *Proper handling of the chain saw will reduce the likelihood of accidental contact with the moving saw chain.*
- **Follow instructions for lubricating, chain tensioning and changing accessories.** *Improperly tensioned or lubricated chain may either break or increase the chance for kickback.*
- **Keep handles dry, clean, and free from oil and grease.** *Greasy, oily handles are slippery causing loss of control.*
- **Cut wood only. Do not use chain saw for purposes not intended. For example: do not use chain saw for cutting plastic, masonry or non-wood building materials. Use**

of the chain saw for operations different than intended could result in a hazardous situation.

## Causes and Operator Prevention of Kickback:

Kickback may occur when the nose or tip of the guide bar touches an object, or when the wood closes in and pinches the saw chain in the cut.

Tip contact in some cases may cause a sudden reverse reaction, kicking the guide bar up and back towards the operator.

Pinching the saw chain along the top of the guide bar may push the guide bar rapidly back towards the operator.

Either of these reactions may cause you to lose control of the saw which could result in serious personal injury. Do not rely exclusively upon the safety devices built into your saw. As a chain saw user, you should take several steps to keep your cutting jobs free from accident or injury.

Kickback is the result of tool misuse and/or incorrect operating procedures or conditions and can be avoided by taking proper precautions as given below:

- **Maintain a firm grip, with thumbs and fingers encircling the chain saw handles, with both hands on the saw and position your body and arm to allow you to resist kickback forces.** Kickback forces can be controlled by the operator, if proper precautions are taken. Do not let go of the chain saw.
- **Do not overreach and do not cut above shoulder height.** This helps prevent unintended tip contact and enables better control of the chain saw in unexpected situations.
- **Only use replacement bars and chains specified by the manufacturer.** Incorrect replacement bars and chains may cause chain breakage and/or kickback.
- **Follow the manufacturer's sharpening and maintenance instructions for the saw chain.** Decreasing the depth gauge height can lead to increased kickback.

## The Following Precautions Should Be Followed to Minimize Kickback:

1. **Grip saw firmly. Hold the chain saw firmly with both hands when the motor is running. Use a firm grip with thumbs and fingers encircling the chain saw handles.** Chain saw will pull forward when cutting on the bottom edge of the bar, and push backward when cutting along the top edge of the bar.
2. **Do not over reach.**
3. **Keep proper footing and balance at all times.**
4. **Don't let the nose of the guide bar contact a log, branch, ground or other obstruction.**
5. **Don't cut above shoulder height.**
6. **Use devices such as low kickback chain and reduced kickback guide bars that reduce the risks associated with kickback.**
7. **Only use replacement bars and chains specified by the manufacturer or the equivalent.**
8. **Never let the moving chain contact any object at the tip of the guide bar.**

9. **Keep the working area free from obstructions such as other trees, branches, rocks, fences, stumps, etc.** Eliminate or avoid any obstruction that your saw chain could hit while you are cutting through a particular log or branch.
10. **Keep your saw chain sharp and properly tensioned. A loose or dull chain can increase the chance of kickback.** Check tension at regular intervals with the motor stopped and tool unplugged, never with the motor running.
11. **Begin and continue cutting only with the chain moving at full speed.** If the chain is moving at a slower speed, there is a greater chance for kickback to occur.
12. **Cut one log at a time.**
13. **Use extreme caution when re-entering a previous cut.** Engage ribbed bumpers into wood and allow chain to reach full speed before proceeding with cut.
14. **Do not attempt plunge cuts or bore cuts.**
15. **Watch for shifting logs or other forces that could close a cut and pinch or fall into chain.**

## Kickback Safety Features



**WARNING:** The following features are included on your saw to help reduce the hazard of kickback; however such features will not totally eliminate this dangerous reaction. As a chain saw user do not rely only on safety devices. You must follow all safety precautions, instructions, and maintenance in this manual to help avoid kickback and other forces which can result in serious injury.

- **Reduced-Kickback Guide Bar,** designed with a small radius tip which reduces the size of the kickback danger zone on bar tip. A reduced - kickback guide bar is one which has been demonstrated to significantly reduce the number and seriousness of kickbacks when tested in accordance with safety requirements for electric chain saws.
- **Low-Kickback Chain,** designed with a contoured depth gauge and guard link which deflect kickback force and allow wood to gradually ride into the cutter.
- Do not operate chain saw while in a tree, on a ladder, on a scaffold, or from any unstable surface.
- Hold tool by insulated gripping surfaces when performing an operation where the cutting tool may contact hidden wiring. Contact with a "live" wire will make exposed metal parts of the tool "live" and shock the operator.
- Do not attempt operations beyond your capacity or experience. Read thoroughly and understand completely all instructions in this manual.
- Before you start chain saw, make sure saw chain is not contacting any object.
- Do not operate a chain saw with one hand! Serious injury to the operator, helpers, or bystanders may result from one handed operation. A chain saw is intended for two-handed use only.
- Keep the handles dry, clean, and free of oil or grease.
- Do not allow dirt, debris, or sawdust to build up on the motor or outside air vents.
- Stop the chain saw before setting it down.
- Do not cut vines and/or small under brush.



- Use extreme caution when cutting small size brush and saplings because slender material may catch the saw chain and be whipped toward you or pull you off balance.



**WARNING:** Some dust created by power sanding, sawing, grinding, drilling, and other construction activities contains chemicals known to the State of California to cause cancer, birth defects or other reproductive harm. Some examples of these chemicals are:

- lead from lead-based paints,
- crystalline silica from bricks and cement and other masonry products, and
- arsenic and chromium from chemically-treated lumber.

Your risk from these exposures varies, depending on how often you do this type of work. To reduce your exposure to these chemicals: work in a well ventilated area, and work with approved safety equipment, such as those dust masks that are specially designed to filter out microscopic particles.

- Avoid prolonged contact with dust from power sanding, sawing, grinding, drilling, and other construction activities. Wear protective clothing and wash exposed areas with soap and water. Allow dust to get into your mouth, eyes, or lay on the skin may promote absorption of harmful chemicals.



**WARNING:** Use of this tool can generate and/or disburse dust, which may cause serious and permanent respiratory or other injury.

## Chainsaw Names and Terms

- *Bucking* - The process of cross cutting a felled tree or log into lengths.
- *Motor Brake* - A device used to stop the saw chain when the trigger is released.
- *Chain Saw Powerhead* - A chain saw without the saw chain and guide bar.
- *Drive Sprocket or Sprocket* - The toothed part that drives the saw chain.
- *Felling* - The process of cutting down a tree.
- *Felling Back Cut* - The final cut in a tree felling operation made on the opposite side of the tree from the notching cut.
- *Front Handle* - The support handle located at or toward the front of the chain saw.
- *Front Hand Guard* - A structural barrier between the front handle of a chain saw and the guide bar, typically located close to the hand position on the front handle.
- *Guide Bar* - A solid railed structure that supports and guides the saw chain.
- *Guide Bar Scabbard* - Enclosure fitted over guide bar to prevent tooth contact when saw is not in use.
- *Kickback* - The backward or upward motion, or both of the guide bar occurring when the saw chain near the nose of the top area of the guide bar contacts any object such as a log or branch, or when the wood closes in and pinches the saw chain in the cut.
- *Kickback, Pinch* - The rapid pushback of the saw which can occur when the wood closes in and pinches the moving saw chain in the cut along the top of the guide bar.
- *Kickback, Rotational* - The rapid upward and backward motion of the saw which can occur when the moving saw

chain near the upper portion of the tip of the guide bar contacts an object, such as a log or branch.

- *Limbing* - Removing the branches from a fallen tree
- *Low-Kickback Chain* - A chain that reduces the kickback performance requirements. (when tested on a representative sample of chain saws.)
- *Normal Cutting Position* - Those positions assumed in performing the bucking and felling cuts.
- *Notching Undercut* - A notch cut in a tree that directs the tree's fall.
- *Rear Handle* - The support handle located at or toward the rear of the saw.
- *Reduced Kickback Guide Bar* - A guide bar which has been demonstrated to reduce kickback significantly.
- *Replacement Saw Chain* - A chain that reduces the kickback performance requirements when tested with specific chain saws.
- *Saw Chain* - A loop of chain having cutting teeth, that cut the wood, and that is driven by the motor and is supported by the guide bar.
- *Ribbed Bumper* - The ribs used when felling or bucking to pivot the saw and maintain position while sawing.
- *Switch* - A device that when operated will complete or interrupt an electrical power circuit to the motor of the chain saw.
- *Switch Linkage* - The mechanism that transmits motion from a trigger to the switch.
- *Switch Lockout* - A movable stop that prevents the unintentional operation of the switch until manually actuated.

## Intended Use

Your DEWALT DCM575 Chainsaw is ideal for pruning applications and cutting logs up to 35 cm in diameter.

## Residual Risks

In spite of the application of the relevant safety regulations and the implementation of safety devices, certain residual risks cannot be avoided. These are:

- *Impairment of hearing.*
- *Risk of personal injury due to flying particles.*
- *Risk of burns due to accessories becoming hot during operation.*
- *Risk of personal injury due to prolonged use.*

## Electrical Safety

The electric motor has been designed for one voltage only. Always check that the battery pack voltage corresponds to the voltage on the rating plate. Also make sure that the voltage of your charger corresponds to that of your mains.



Your DEWALT charger is double insulated in accordance with EN60335; therefore no earth wire is required.

If the supply cord is damaged, it must be replaced by a specially prepared cord available through the DEWALT service organisation.

## Mains Plug Replacement (U.K. & Ireland Only)

If a new mains plug needs to be fitted:

- Safely dispose of the old plug.
- Connect the brown lead to the live terminal in the plug.
- Connect the blue lead to the neutral terminal.



**WARNING:** No connection is to be made to the earth terminal.

Follow the fitting instructions supplied with good quality plugs. Recommended fuse: 3 A.

## Using an Extension Cable

An extension cord should not be used unless absolutely necessary. Use an approved extension cable suitable for the power input of your charger (see **Technical Data**). The minimum conductor size is 1 mm<sup>2</sup>; the maximum length is 30 m.

When using a cable reel, always unwind the cable completely.

## SAVE THESE INSTRUCTIONS

## Chargers

DEWALT chargers require no adjustment and are designed to be as easy as possible to operate.

## Important Safety Instructions for All Battery Chargers

**SAVE THESE INSTRUCTIONS:** This manual contains important safety and operating instructions for compatible battery chargers (refer to **Technical Data**).

- Before using charger, read all instructions and cautionary markings on charger, battery pack, and product using battery pack.



**WARNING:** Shock hazard. Do not allow any liquid to get inside charger. Electric shock may result.



**WARNING:** We recommend the use of a residual current device with a residual current rating of 30mA or less.



**CAUTION:** Burn hazard. To reduce the risk of injury, charge only DEWALT rechargeable batteries. Other types of batteries may burst causing personal injury and damage.



**CAUTION:** Children should be supervised to ensure that they do not play with the appliance.

**NOTICE:** Under certain conditions, with the charger plugged into the power supply, the exposed charging contacts inside the charger can be shorted by foreign material. Foreign materials of a conductive nature such as, but not limited to, steel wool, aluminum foil or any buildup of metallic particles should be kept away from charger cavities. Always unplug the charger from the power supply when there is no battery pack in the cavity. Unplug charger before attempting to clean

- **DO NOT attempt to charge the battery pack with any chargers other than the ones in this manual.** The charger and battery pack are specifically designed to work together.

- **These chargers are not intended for any uses other than charging DEWALT rechargeable batteries.** Any other uses may result in risk of fire, electric shock or electrocution.
- **Do not expose charger to rain or snow.**
- **Pull by plug rather than cord when disconnecting charger.** This will reduce risk of damage to electric plug and cord.
- **Make sure that cord is located so that it will not be stepped on, tripped over, or otherwise subjected to damage or stress.**
- **Do not use an extension cord unless it is absolutely necessary.** Use of improper extension cord could result in risk of fire, electric shock, or electrocution.
- **Do not place any object on top of charger or place the charger on a soft surface that might block the ventilation slots and result in excessive internal heat.** Place the charger in a position away from any heat source. The charger is ventilated through slots in the top and the bottom of the housing.
- **Do not operate charger with damaged cord or plug—** have them replaced immediately.
- **Do not operate charger if it has received a sharp blow, been dropped, or otherwise damaged in any way.** Take it to an authorised service centre.
- **Do not disassemble charger; take it to an authorised service centre when service or repair is required.** Incorrect reassembly may result in a risk of electric shock, electrocution or fire.
- In case of damaged power supply cord the supply cord must be replaced immediately by the manufacturer, its service agent or similar qualified person to prevent any hazard.
- **Disconnect the charger from the outlet before attempting any cleaning.** This will reduce the risk of electric shock. Removing the battery pack will not reduce this risk.
- **NEVER** attempt to connect two chargers together.
- **The charger is designed to operate on standard 230V household electrical power. Do not attempt to use it on any other voltage.** This does not apply to the vehicular charger.



## Charging a Battery (Fig. B)

1. Plug the charger into an appropriate outlet before inserting battery pack.
2. Insert the battery pack **7** into the charger, making sure the battery pack is fully seated in the charger. The red (charging) light will blink repeatedly indicating that the charging process has started.
3. The completion of charge will be indicated by the red light remaining ON continuously. The battery pack is fully charged and may be used at this time or left in the charger. To remove the battery pack from the charger, push the battery release button **15** on the battery pack.

**NOTE:** To ensure maximum performance and life of lithium-ion battery packs, charge the battery pack fully before first use.

## Charger Operation

Refer to the indicators below for the charge status of the battery pack.

Charge Indicators	
 Charging	--- ---
 Fully Charged	—————
 Hot/Cold Pack Delay*	--- —————

\*The red light will continue to blink, but a yellow indicator light will be illuminated during this operation. Once the battery pack has reached an appropriate temperature, the yellow light will turn off and the charger will resume the charging procedure.

The compatible charger(s) will not charge a faulty battery pack. The charger will indicate faulty battery by refusing to light or by displaying problem pack or charger blink pattern.

**NOTE:** This could also mean a problem with a charger.

If the charger indicates a problem, take the charger and battery pack to be tested at an authorised service centre.

### Hot/Cold Pack Delay

When the charger detects a battery pack that is too hot or too cold, it automatically starts a Hot/Cold Pack Delay, suspending charging until the battery pack has reached an appropriate temperature. The charger then automatically switches to the pack charging mode. This feature ensures maximum battery pack life.

A cold battery pack will charge at a slower rate than a warm battery pack. The battery pack will charge at that slower rate throughout the entire charging cycle and will not return to maximum charge rate even if the battery pack warms.

The DCB118 charger is equipped with an internal fan designed to cool the battery pack. The fan will turn on automatically when the battery pack needs to be cooled. Never operate the charger if the fan does not operate properly or if ventilation slots are blocked. Do not permit foreign objects to enter the interior of the charger.

### Electronic Protection System

XR Li-Ion tools are designed with an Electronic Protection System that will protect the battery pack against overloading, overheating or deep discharge.

The tool will automatically turn off if the Electronic Protection System engages. If this occurs, place the lithium-ion battery pack on the charger until it is fully charged.

### Wall Mounting

These chargers are designed to be wall mountable or to sit upright on a table or work surface. If wall mounting, locate the charger within reach of an electrical outlet, and away from a corner or other obstructions which may impede air flow. Use the back of the charger as a template for the location of the mounting screws on the wall. Mount the charger securely using drywall screws (purchased separately) at least 25.4 mm long with a screw head diameter of 7–9 mm, screwed into wood to an optimal depth leaving approximately 5.5 mm of the screw

exposed. Align the slots on the back of the charger with the exposed screws and fully engage them in the slots.

## Charger Cleaning Instructions

**⚠ WARNING: Shock hazard. Disconnect the charger from the AC outlet before cleaning.** Dirt and grease may be removed from the exterior of the charger using a cloth or soft non-metallic brush. Do not use water or any cleaning solutions. Never let any liquid get inside the tool; never immerse any part of the tool into a liquid.

## Battery Packs

### Important Safety Instructions for All Battery Packs

When ordering replacement battery packs, be sure to include catalogue number and voltage.

The battery pack is not fully charged out of the carton. Before using the battery pack and charger, read the safety instructions below. Then follow charging procedures outlined.

#### READ ALL INSTRUCTIONS

- **Do not charge or use battery in explosive atmospheres, such as in the presence of flammable liquids, gases or dust.** Inserting or removing the battery from the charger may ignite the dust or fumes.
- **Never force battery pack into charger. Do not modify battery pack in any way to fit into a non-compatible charger as battery pack may rupture causing serious personal injury.**
- Charge the battery packs only in DEWALT chargers.
- **DO NOT splash or immerse in water or other liquids.**
- **Do not store or use the tool and battery pack in locations where the temperature may reach or exceed 40 °C (104 °F) (such as outside sheds or metal buildings in summer).**
- **Do not incinerate the battery pack even if it is severely damaged or is completely worn out.** The battery pack can explode in a fire. Toxic fumes and materials are created when lithium-ion battery packs are burned.
- **If battery contents come into contact with the skin, immediately wash area with mild soap and water.** If battery liquid gets into the eye, rinse water over the open eye for 15 minutes or until irritation ceases. If medical attention is needed, the battery electrolyte is composed of a mixture of liquid organic carbonates and lithium salts.
- **Contents of opened battery cells may cause respiratory irritation.** Provide fresh air. If symptoms persists, seek medical attention.

**⚠ WARNING: Burn hazard.** Battery liquid may be flammable if exposed to spark or flame.

**⚠ WARNING: Never attempt to open the battery pack for any reason.** If battery pack case is cracked or damaged, do not insert into charger. Do not crush, drop or damage battery pack. Do not use a battery pack or charger that has received a sharp blow, been dropped, run over or damaged in any way (i.e., pierced with a nail, hit with

a hammer, stepped on). Electric shock or electrocution may result. Damaged battery packs should be returned to service centre for recycling.



**WARNING: Fire hazard. Do not store or carry the battery pack so that metal objects can contact exposed battery terminals.** For example, do not place the battery pack in aprons, pockets, tool boxes, product kit boxes, drawers, etc., with loose nails, screws, keys, etc.



**CAUTION: When not in use, place tool on its side on a stable surface where it will not cause a tripping or falling hazard.** Some tools with large battery packs will stand upright on the battery pack but may be easily knocked over.

## Transportation



**WARNING: Fire hazard.** Transporting batteries can possibly cause fire if the battery terminals inadvertently come in contact with conductive materials. When transporting batteries, make sure that the battery terminals are protected and well insulated from materials that could contact them and cause a short circuit.

DeWALT batteries comply with all applicable shipping regulations as prescribed by industry and legal standards which include UN Recommendations on the Transport of Dangerous Goods; International Air Transport Association (IATA) Dangerous Goods Regulations, International Maritime Dangerous Goods (IMDG) Regulations, and the European Agreement Concerning The International Carriage of Dangerous Goods by Road (ADR). Lithium-ion cells and batteries have been tested to section 38.3 of the UN Recommendations on the Transport of Dangerous Goods Manual of Tests and Criteria.

In most instances, shipping a DeWALT battery pack will be excepted from being classified as a fully regulated Class 9 Hazardous Material. In general, only shipments containing a lithium-ion battery with an energy rating greater than 100 Watt Hours (Wh) will require being shipped as fully regulated Class 9. All lithium-ion batteries have the Watt Hour rating marked on the pack. Furthermore, due to regulation complexities, DeWALT does not recommend air shipping lithium-ion battery packs alone regardless of Watt Hour rating. Shipments of tools with batteries (combo kits) can be air shipped as excepted if the Watt Hour rating of the battery pack is no greater than 100 Whr. Regardless of whether a shipment is considered excepted or fully regulated, it is the shipper's responsibility to consult the latest regulations for packaging, labeling/marketing and documentation requirements.

The information provided in this section of the manual is provided in good faith and believed to be accurate at the time the document was created. However, no warranty, expressed or implied, is given. It is the buyer's responsibility to ensure that its activities comply with the applicable regulations.

## Transporting the FLEXVOLT™ Battery

The DeWALT FLEXVOLT™ battery has two modes: **Use** and **Transport**.

**Use Mode:** When the FLEXVOLT™ battery stands alone or is in a DeWALT 18V product, it will operate as an 18V battery. When

the FLEXVOLT™ battery is in a 54V or a 108V (two 54V batteries) product, it will operate as a 54V battery.

**Transport Mode:** When the cap is attached to the FLEXVOLT™ battery, the battery is in Transport mode. Keep the cap for shipping.

When in Transport mode, strings of cells are electrically disconnected within the pack resulting in 3 batteries with a lower Watt hour (Wh) rating as compared to 1 battery with a higher Watt hour rating. This increased quantity of 3 batteries with the lower Watt hour rating can exempt the pack from certain shipping regulations that are imposed upon the higher Watt hour batteries.

For example, the Transport Wh rating might indicate 3 x 36 Wh, meaning 3 batteries of 36 Wh each.

The Use Wh rating might indicate 108 Wh (1 battery implied).

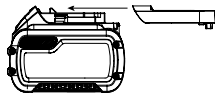

Example of Use and Transport Label Marking



## Storage Recommendations

1. The best storage place is one that is cool and dry away from direct sunlight and excess heat or cold. For optimum battery performance and life, store battery packs at room temperature when not in use.
2. For long storage, it is recommended to store a fully charged battery pack in a cool, dry place out of the charger for optimal results.

**NOTE:** Battery packs should not be stored completely depleted of charge. The battery pack will need to be recharged before use.

## Labels on Charger and Battery Pack

In addition to the pictographs used in this manual, the labels on the charger and the battery pack may show the following pictographs:



Read instruction manual before use.



See **Technical Data** for charging time.



Do not probe with conductive objects.



Do not charge damaged battery packs.



Do not expose to water.



Have defective cords replaced immediately.



Charge only between 4 °C and 40 °C.



Only for indoor use.



Discard the battery pack with due care for the environment.



Charge DEWALT battery packs only with designated DEWALT chargers. Charging battery packs other than the designated DEWALT batteries with a DEWALT charger may make them burst or lead to other dangerous situations.



Do not incinerate the battery pack.



USE (without transport cap). Example: Wh rating indicates 108 Wh (1 battery with 108 Wh).



TRANSPORT (with built-in transport cap). Example: Wh rating indicates 3 x 36 Wh (3 batteries of 36 Wh).

### Battery Type

The DCM575 operates on a 54 volt battery pack. These battery packs may be used: DCB546, DCB547. Refer to **Technical Data** for more information.

### Package Contents

The package contains:

- 1 Chainsaw
- 1 Scabbard
- 1 Bar 40 cm
- 1 Chain 40 cm
- 1 Instruction manual

### NO BATTERY OR CHARGER INCLUDED

- 1 Li-Ion battery pack\*\*
- 1 Li-Ion battery charger\*\*

\*\*Included with DCM575X1 Only

- Check for damage to the tool, parts or accessories which may have occurred during transport.
- Take the time to thoroughly read and understand this manual prior to operation.

### Markings on Tool

The following pictograms are shown on the tool:



Read instruction manual before use.



Wear ear protection.



Wear eye protection.



Do not leave in rain.



Tip contact can cause the guide bar to move suddenly upward and backward, which can cause serious injury.



Contact of the guide bar tip with any object should be avoided.



Rotational direction of the saw chain.



Always use two hands when operating the chainsaw.



Switch the tool off. Before performing any maintenance on the tool, remove the battery from the tool.



Directive 2000/14/EC guaranteed sound power.

### Date Code Position

The date code, which also includes the year of manufacture, is printed into the housing.

Example:

2018 XX XX  
Year of Manufacture

### Description (Fig. A)



**WARNING:** Never modify the power tool or any part of it. Damage or personal injury could result.

- 1 Variable speed trigger switch
- 2 Lock-off lever
- 3 Chain brake / front hand guard
- 4 Guide bar
- 5 Saw chain
- 6 Sprocket cover
- 7 Battery Pack
- 8 Bar adjust locking knob
- 9 Chain tensioning knob
- 10 Oil level indicator
- 11 Guide bar scabbard
- 12 Rear handle
- 13 Front handle
- 14 Battery housing
- 15 Battery release button
- 16 Oil cap (not shown)

### Intended Use

Your chainsaw has been designed for professional cutting applications.

**DO NOT** use under wet conditions or in the presence of flammable liquids or gases.

This chainsaw is a professional power tool.

**DO NOT** let children come into contact with the tool.

Supervision is required when inexperienced operators use this tool.

- **Young children and the infirm.** This appliance is not intended for use by young children or infirm persons without supervision.
- This product is not intended for use by persons (including children) suffering from diminished physical, sensory or mental abilities; lack of experience, knowledge or skills unless they are supervised by a person responsible for their safety. Children should never be left alone with this product.

## ASSEMBLY AND ADJUSTMENTS



**WARNING:** To reduce the risk of serious personal injury, turn tool off and disconnect battery pack before making any adjustments or removing/installing attachments or accessories. An accidental start-up can cause injury.



**WARNING:** Use only DEWALT battery packs and chargers.

### Inserting and Removing the Battery Pack from the Tool (Fig. C–E)

**NOTE:** Make sure your battery pack **7** is fully charged.

#### To Install the Battery Pack into the Tool

1. Align the battery pack **7** with the rails inside the tool (Fig. C).
2. Slide it into the tool until the battery pack is firmly seated and ensure that you hear the lock snap into place.

#### To Remove the Battery Pack from the Tool

1. Press the release button **15** and firmly pull the battery pack out of the tool handle (Fig. D).
2. Insert battery pack into the charger as described in the charger section of this manual.

### Fuel Gauge Battery Packs (Fig. E)

Some DEWALT battery packs include a fuel gauge which consists of three green LED lights that indicate the level of charge remaining in the battery pack.

To actuate the fuel gauge, press and hold the fuel gauge button **17**. A combination of the three green LED lights will illuminate designating the level of charge left. When the level of charge in the battery is below the usable limit, the fuel gauge will not illuminate and the battery will need to be recharged.

**NOTE:** The fuel gauge is only an indication of the charge left on the battery pack. It does not indicate tool functionality and is subject to variation based on product components, temperature and end-user application.

## ASSEMBLY

### Installing the Guide Bar and Saw Chain (Fig. A, F–H, K)



**CAUTION:** Sharp chain. Always wear protective gloves when handling the chain. The chain is sharp and can cut you when it is not running.



**WARNING:** Sharp moving chain. To prevent accidental operation, ensure that battery is removed from the tool

before performing the following operations. Failure to do this could result in serious personal injury.

The saw chain **5** and guide bar **4** are packed separately in the carton. The chain has to be attached to the bar, and both must be attached to the body of the tool.

- Place the saw on a flat, firm surface.
- Flip up locking lever and rotate the bar adjust locking knob **8** counterclockwise as shown in Figure F to remove sprocket cover **6**.
- Wearing protective gloves, grasp the saw chain **5** and wrap it around the guide bar **4**, ensuring the teeth are facing the correct direction (see Figure K)
- Ensure the chain is properly set in the slot around the entire guide bar.
- Place the saw chain around the sprocket **18**. While lining up the slot on the guide bar with chain tensioning pin **20**, and the bolt **19**, on the base of the tool as shown in Figure G.
- Once in place, hold the bar still, replace sprocket cover **6**. Make sure tool-free tension assembly bolt hole on the cover lines up with the bolt **19**, in the main housing. Flip up locking lever and rotate the bar adjust locking knob **8** clockwise until it clicks, then loosen knob one full turn, so that the saw chain can be properly tensioned.
- Rotate the chain tensioning knob **9** clockwise to increase tension as shown in Figure H. Make sure the saw chain **5** is snug around the guide bar **4**. Tighten the bar adjust locking knob until it clicks. The bar is secure after three audible clicks are heard. Further tightening is not required.

### Adjusting Chain Tension (Fig. A, I)



**CAUTION:** Sharp chain. Always wear protective gloves when handling the chain. The chain is sharp and can cut you when it is not running.



**WARNING:** Sharp moving chain. To prevent accidental operation, ensure that battery is removed from the tool before performing the following operations. Failure to do this could result in serious personal injury.

- With the saw on a flat, firm surface, check the saw chain **5** tension. The tension is correct when the chain snaps back after being pulled 3 mm away from the guide bar **4** with light force from the index finger and thumb as shown in Figure I. There should be no “sag” between the guide bar and the chain on the underside as shown in Figure I.
- To adjust saw chain tension, flip up locking tab and rotate the bar adjust locking knob **8** counterclockwise one full turn. Rotate the chain tensioning knob **9** clockwise until the chain tension is correct as instructed above.
- Do not over-tension the chain as this will lead to excessive wear and will reduce the life of the bar and chain.
- Once chain tension is correct, securely tighten bar adjust locking knob.

**NOTE:** The bar adjust locking knob has a detent tightening system. The sprocket cover is secure after three audible clicks are heard. Further tightening is not required.

- When the chain is new, check the tension frequently (after removing battery) during the first 2 hours of use as a new chain stretches slightly.

## Replacing the Saw Chain (Fig. A, K)

 **CAUTION:** Sharp chain. Always wear protective gloves when handling the chain. The chain is sharp and can cut you when it is not running.

 **WARNING:** Sharp moving chain. To prevent accidental operation, ensure that battery is removed from the tool before performing the following operations. Failure to do this could result in serious personal injury.

- Flip up locking tab and rotate the bar adjust locking knob **8** counterclockwise to release chain tension.
- Remove sprocket cover **6** as described in **Installing the Guide Bar and Saw Chain** section.
- Lift the worn saw chain **5** out of the groove in the guide bar **4**.
- Place the new chain in the slot of the guide bar, making sure the saw teeth are facing the correct direction by matching the arrow on the chain with the graphic on the sprocket cover **6** shown in Figure K.
- Follow instructions for **Installing the Guide Bar and Saw Chain**.

Replacement chain and bar are available from your nearest DEWALT service center.

- DCM575 requires replacement chain # DWRC1600, service part number N594321. Replacement 40 cm bar, service part number N594320.

## Saw Chain and Guide Bar Oiling (Fig. L)

### Auto Oiling System

This chain saw is equipped with an auto oiling system that keeps the saw chain and guide bar constantly lubricated. The oil level indicator **10** shows the level of the oil in the chain saw. If the oil level is less than a quarter full, remove the battery from the chain saw and refill with the correct type of oil. Always empty oil tank when finished cutting.

**NOTE:** Use a high quality bar and chain oil for proper chain and bar lubrication. As a temporary substitute, a non-detergent SAE30 weight motor oil can be used. The use of a vegetable based bar and chain oil is recommended when pruning trees. Mineral oil is not recommended because it may harm trees. Never use waste oil or very thick oil. These may damage your chain saw.

### Filling the Oil Reservoir

- Flip down locking lever and unscrew counterclockwise a quarter turn and then remove the oil cap **16**. Fill the reservoir with the recommended bar and chain oil until the oil level has reached the top of the oil level indicator **10**.
- Refit the oil cap and tighten clockwise a quarter turn. Flip up locking lever to its locked position.
- Periodically switch the chain saw off and check the oil level indicator to ensure the bar and chain are being properly oiled.

## Transporting Saw (Fig. A, M)

- Always remove the battery from the tool and cover the guide bar **4** with the scabbard **11** (Figure M) when transporting the saw.
- Engage chain brake by pushing chain brake / front hand guard **3** forward.

## OPERATION

### Instructions for Use

 **WARNING:** Always observe the safety instructions and applicable regulations.

 **WARNING:** To reduce the risk of serious personal injury, turn tool off and disconnect battery pack before making any adjustments or removing/installing attachments or accessories. An accidental start-up can cause injury.

### Proper Hand Position (Fig. A, J)

 **WARNING:** To reduce the risk of serious personal injury, ALWAYS use proper hand position as shown.

 **WARNING:** To reduce the risk of serious personal injury, ALWAYS hold securely in anticipation of a sudden reaction.

Proper hand position requires the left hand on the front handle **13**, with the right hand on the rear handle **12**.

### Operating the Chain Saw (Fig. A, N–O)

 **WARNING:** Read and understand all instructions. Failure to follow all instructions listed below may result in electric shock, fire and/or serious personal injury.

- Guard Against Kickback which can result in severe injury or death. See Important Safety Instructions **Guard Against Kickback**, to avoid the risk of kickback.
- Do not overreach. Do not cut above chest height. Make sure your footing is firm. Keep feet apart. Divide your weight evenly on both feet.
- Use a firm grip with your left hand on the front handle **13** and your right hand on the rear handle **12** so that your body is to the left of the guide bar.
- Do not hold chain saw by front hand guard/ chain brake **3**. Keep elbow of left arm locked so that left arm is straight to withstand a kickback.

 **WARNING:** Never use a cross-handed grip (left hand on the rear handle and right hand on the front handle).

 **WARNING:** Never allow any part of your body to be in line with the guide bar **4** when operating the chain saw.

- Never operate while in a tree, in any awkward position or on a ladder or other unstable surface. You may lose control of saw causing severe injury.
- Keep the chain saw running at full speed the entire time you are cutting.
- Allow the chain to cut for you. Exert only light pressure. Do not put pressure on chain saw at end of cut.

**!** **WARNING:** When not in use always have the chain brake engaged and battery removed.

## On / Off Switch

Always be sure of your footing and grip the chain saw firmly with both hands with the thumb and fingers encircling both handles.

This tool is equipped with a variable speed trigger switch. To turn the unit on, ensure chain brake is not engaged. Push down on the lock off lever **2**, shown in Figure N, and squeeze the trigger switch **1**. Once the unit is running, you may release the lock off lever. The farther you depress the trigger, the faster it will operate. In order to keep the unit running you must continue to squeeze the trigger. To turn the unit off, release the trigger.

**NOTE:** If too much force is applied while making a cut the saw will turn off. To restart saw, you must release the lock off lever **2** and the trigger switch **1** before the saw will restart. Begin your cut again this time with less force. Allow the saw to cut at its own pace.

**!** **WARNING:** Never attempt to lock a switch in the ON position.

## Setting The Chain Brake

Your chain saw is equipped with a motor chain braking system which will stop the chain quickly in case of kickback.

- Remove the battery from the tool.
- To engage the chain brake, push the chain brake / front hand guard **3** forward until it clicks into place.
- Pull the chain brake / front hand guard **3** towards the front handle **13** into the "set" position as shown in Figure O.
- The tool is now ready to use.

**NOTE:** In the event of kickback, your left hand will come in contact with the front guard, pushing it forward, toward the workpiece. This will stop the tool.

## Testing The Chain Brake

Test the chain brake before every use to make sure it operates correctly.

- Place the tool on a flat, firm surface. Make sure the saw chain **5** is clear of the ground.
- Grip the tool firmly with both hands and turn the chain saw on.
- Rotate your left hand forward around the front handle **13** so the back of your hand comes in contact with the Chain brake / front hand guard **3** and push it forward, toward the workpiece. The saw chain should stop immediately.

**NOTE:** If saw does not stop immediately, stop use of tool and bring it to a DEWALT service center nearest you.

**!** **WARNING:** Make sure to set chain brake before cutting.

## Common Cutting Techniques (Fig. A, P, Q, U, V, W)

### Felling

The process of cutting down a tree. Be sure battery is fully charged before felling a tree so you can finish on a single charge. Do not fell trees in high wind conditions.

**!** **WARNING:** Felling can result in injury. It should only be performed by a trained person.

- A retreat path should be planned and cleared as necessary before cuts are started. The retreat path should extend back and diagonally to the rear of the expected line of fall. (Figure U)

Fig. U

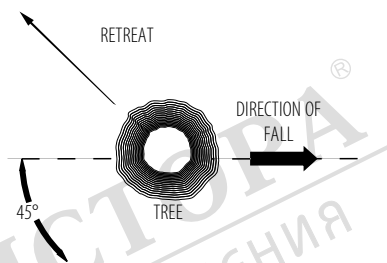

- Before felling is started, consider the natural lean of the tree, the location of larger branches and the wind direction to judge which way the tree will fall. Have wedges (wood, plastic or aluminum) and a heavy mallet handy. Remove dirt, stones, loose bark, nails, staples, and wire from the tree where the felling cuts are to be made.
- Notching Undercut - Make the notch 1/3 of the diameter of the tree, perpendicular to the direction of the fall. Make the lower horizontal notching cut first. This will help to avoid pinching of either the saw chain or the guide bar when the second notch cut is being made (Figure V).
- Felling Back Cut - Make the felling back cut at least 51 mm higher than the horizontal notching cut. Keep the felling back cut parallel to the horizontal notching cut. Make the felling back cut so enough wood is left to act as a hinge. The hinge wood keeps the tree from twisting and falling in the wrong direction. Do not cut through the hinge (Figure V).
- As the felling cut gets close to the hinge the tree should begin to fall. If there is any chance that the tree may not fall in the desired direction or it may rock back and bind the saw chain, stop cutting before the felling cut is complete and use wedges to open the cut and drop the tree along the desired line of fall. When the tree begins to fall remove the chain saw from the cut, stop the motor, put the chain saw down, then use the retreat path planned. Be alert for overhead limbs falling and watch your footing.



Fig. V

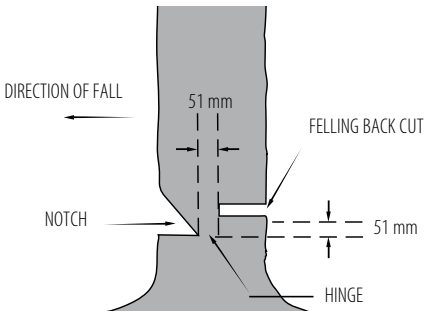

**Limbing**

Removing the branches from a fallen tree. When limbing, leave larger lower limbs to support the log off the ground. Remove the small limbs in one cut. Branches under tension should be cut from the bottom of the branch towards the top to avoid binding the chain saw as shown in Figure P. Trim limbs from opposite side keeping tree stem between you and saw. Never make cuts with saw between your legs or straddle the limb to be cut.

**Bucking**

**! WARNING:** *Recommend that first time users should practice cutting on a saw horse.*

Cutting a felled tree or log into lengths. How you should cut depends on how the log is supported. Use a saw horse (Figure Q) whenever possible.

- Always start a cut with the chain running at full speed.
- Place the bottom spike **22** of the chain saw behind the area of the initial cut as shown in Figure W.
- Turn the chain saw on then rotate the chain and bar down into the tree, using the spike as a hinge.
- Once the chain saw gets to a 45 degree angle, level the chain saw again and repeat steps until you cut fully through.
- When the tree is supported along its entire length, make a cut from the top (overbuck), but avoid cutting the earth as this will dull your saw quickly.

Fig. W

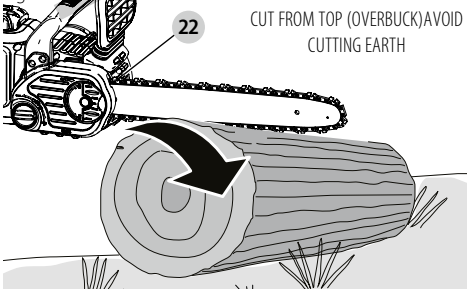

- **Figure X** - When supported at one end  
First, cut 1/3 the diameter from the underside (underbuck). Then make the finishing cut by overbucking to meet the first cut.

Fig. X

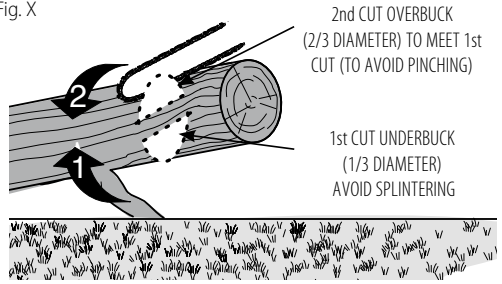

- **Figure Y** - When supported at both ends.  
First, cut 1/3 down from the top overbuck. Then make the finished cut by underbucking the lower 2/3 to meet the first cut.

Fig. Y

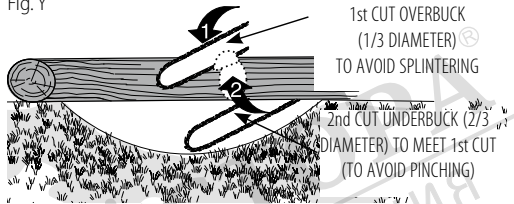

- When on a slope always stand on the uphill side of the log. When "cutting through", to maintain complete control reduce the cutting pressure near the end of the cut without relaxing your grip on the chain saw handles. Don't let the chain contact the ground. After completing the cut, wait for the saw chain to stop before you move the chain saw. Always stop the motor before moving from cut to cut.

**CARE AND MAINTENANCE**

Use only mild soap and damp cloth to clean the tool. Do not use solvents to clean the plastic housing of the saw. Never let any liquid get inside the tool; never immerse any part of the tool into a liquid.

**IMPORTANT:** To assure product SAFETY and RELIABILITY, repairs, maintenance and adjustment should be performed by a DeWALT authorized service center, always using identical replacement parts.

Regular maintenance ensures a long effective life for your chain saw.

**Chain and Bar**

After every few hours of use, remove the sprocket cover, guide bar and chain and clean thoroughly using a soft bristle brush. Ensure oiling hole on bar is clear of debris. When replacing dull chains with sharp chains it is good practice to flip the chain bar from bottom to top.

**Saw Chain Sharpening (Fig. R-T)**

- **! CAUTION:** *Sharp chain. Always wear protective gloves when handling the chain. The chain is sharp and can cut you when it is not running.*

**!** **WARNING:** Sharp moving chain. To prevent accidental operation, ensure that battery is removed from the tool before performing the following operations. Failure to do this could result in serious personal injury.

**NOTE:** The cutters will dull immediately if they touch the ground or a nail while cutting.

To get the best possible performance from your chain saw it is important to keep the teeth of the chain sharp. Follow these helpful tips for proper saw chain sharpening:

1. For best results use a 4.5 mm file and a file holder or filing guide to sharpen your chain. This will ensure you always get the correct sharpening angles.
2. Place the file holder flat on the top plate and depth gauge of the cutter.
3. **Figure R-** Keep the correct top plate **21** filing angle line of 30° on your file guide parallel with your chain (file at 60° from chain viewed from the side).
4. Sharpen cutters on one side of the chain first. File from the inside of each cutter to the outside. Then turn your saw around and repeat the processes (2,3,4) for cutters on the other side of the chain.

**NOTE:** Use a flat file to file the tops of the rakers (portion of chain link in front of the cutter) so they are about 0.635 mm below the tips of the cutters as shown in **Figure S**.

5. **Figure T-** Keep all cutter lengths equal.
6. If damage is present on the chrome surface of the top plates or side plates, file back until such damage is removed.

**!** **CAUTION:** After filing, the cutter will be sharp, use extra caution during this process.

**NOTE:** Each time the chain is sharpened, it loses some of the low kickback qualities and extra caution should be used. It is recommended that a chain be sharpened no more than four times.

## Accessories

**!** **WARNING:** The use of accessories not recommended in this manual may be hazardous.

Replacement chain and bar are available from your nearest DEWALT authorized service center. For use only with low kick back bar and chain.

Available bars and chains for **DCM575:**

- Bar: **40 cm** service part number N594320  
**46 cm** service part number N594315
- Chain: **40 cm** service part number N594321  
**46 cm** service part number N594318

## MAINTENANCE

Your DEWALT power tool has been designed to operate over a long period of time with a minimum of maintenance. Continuous satisfactory operation depends upon proper tool care and regular cleaning.

**!** **WARNING:** To reduce the risk of serious personal injury, turn tool off and disconnect battery pack before making any adjustments or removing/

installing attachments or accessories. An accidental start-up can cause injury.

The charger and battery pack are not serviceable.



## Lubrication

Refer to **Saw Chain and Guide Bar Oiling** (Fig. L)



## Cleaning

**!** **WARNING:** Blow dirt and dust out of the main housing with dry air as often as dirt is seen collecting in and around the air vents. Wear approved eye protection and approved dust mask when performing this procedure.

**!** **WARNING:** Never use solvents or other harsh chemicals for cleaning the non-metallic parts of the tool. These chemicals may weaken the materials used in these parts. Use a cloth dampened only with water and mild soap. Never let any liquid get inside the tool; never immerse any part of the tool into a liquid.

## Optional Accessories

**!** **WARNING:** Since accessories, other than those offered by DEWALT, have not been tested with this product, use of such accessories with this tool could be hazardous. To reduce the risk of injury, only DEWALT recommended accessories should be used with this product.

Consult your dealer for further information on the appropriate accessories.

## Protecting the Environment



Separate collection. Products and batteries marked with this symbol must not be disposed of with normal household waste.

Products and batteries contain materials that can be recovered or recycled reducing the demand for raw materials. Please recycle electrical products and batteries according to local provisions. Further information is available at [www.2helpU.com](http://www.2helpU.com).

## Rechargeable Battery Pack

This long life battery pack must be recharged when it fails to produce sufficient power on jobs which were easily done before. At the end of its technical life, discard it with due care for our environment:

- Run the battery pack down completely, then remove it from the tool.
- Li-Ion cells are recyclable. Take them to your dealer or a local recycling station. The collected battery packs will be recycled or disposed of properly.

## TROUBLESHOOTING

<b>Problem</b>	<b>Solution</b>
Unit will not start.	<ul style="list-style-type: none"> <li>• Check battery installation.</li> <li>• Check battery charging requirements.</li> <li>• Check that lock off is fully pushed down prior to moving main trigger.</li> </ul>
Unit shuts down in use.	<ul style="list-style-type: none"> <li>• Charge battery.</li> <li>• Unit is being forced. Restart and apply less pressure.</li> </ul>
Battery won't charge.	<ul style="list-style-type: none"> <li>• Insert battery into charger until red charging light illuminates. Charge up to 8 hours if battery is totally drained.</li> <li>• Plug charger into a working outlet. Refer to <b>Important Charging Notes</b> for more details.</li> <li>• Check current at receptacle by plugging an appliance.</li> <li>• Check to see if receptacle is connected to a light switch which turns power off when you turn out the lights.</li> <li>• Move charger and appliance to a surrounding air temperature of above 4,5 °C or below 40,5 °C.</li> </ul>
Bar / Chain overheated.	<ul style="list-style-type: none"> <li>• Refer to <b>Adjusting Chain Tension</b> section.</li> <li>• Refer to <b>Chain Oiling</b> section.</li> </ul>
Chain is loose.	<ul style="list-style-type: none"> <li>• Refer to <b>Adjusting Chain Tension</b> section.</li> </ul>
Poor cut quality.	<ul style="list-style-type: none"> <li>• Refer to <b>Adjusting Chain Tension</b> section. <b>NOTE:</b> Excessive tension leads to excessive wear and reduction in life of bar and chain. Lubricate before each cut. Refer to <b>Replacing the Saw Chain</b> section.</li> </ul>
Unit runs but does not cut.	<ul style="list-style-type: none"> <li>• Chain could be installed backwards. Refer to sections for installing and removing chain.</li> </ul>
Unit does not oil.	<ul style="list-style-type: none"> <li>• Refill oil reservoir.</li> <li>• Clean guide bar, sprocket and sprocket cover. Refer to <b>Care And Maintenance</b> section.</li> </ul>

