

ThermoCamera HighSense (Pro)



DE 02

EN 28

NL

FR

ES

IT

PT



MIX-IMAGE

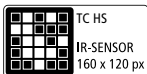

TC HS

IR-SENSOR

160 x 120 px

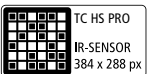

TC HS PRO

IR-SENSOR

384 x 288 px



25 FRAMES

PER SECOND



HOT SPOT /

COLD SPOT

INDICATION



SPOT

CENTER

INDICATION



FOCUSABLE

LENS



USB

Type C



DATA

STORAGE



LI-ION

BATTERY



COLOUR TFT



32x

ZOOM



REC

IMAGE /

VIDEO



CUSTOM

APPS

Laserliner

! Completely read through the operating instructions, the „Warranty and Additional Information“ booklet as well as the latest information under the internet link at the end of these instructions. Follow the instructions they contain. This documents must be kept in a safe place and if the device is passed on, this documents must be passed on with it.

Function / Application

This thermal imaging camera provides non-contact temperature measurement of surfaces. The device evaluates the radiation in the infrared wavelength via an integral, uncooled microbolometer. The sensor's imaging technology provides a visual image of the temperatures surrounding the inspected object. Optimum visualisation of the temperature differences is achieved by colour coding the different measured temperatures in a thermogram using a false colour display. The additional digital camera allows photographs to be taken of the inspected area for recording purposes. Amongst other things, the product is suitable for detecting thermal bridges and insulation errors in buildings, analysing heating systems, locating overheated components, cables and fuses, and identifying defective solar cells in PV modules. The device is operated directly using the colour touchscreen display and the focus is adjusted manually. Analysis can be carried out on infrared, digital or MIX images. The MIX image provides an extremely easy to interpret and comprehensive representation of the temperature profiles by combining digital and infrared images. Measured data can be saved to an exchangeable SD card and transferred to a PC via the USB-C interface. The CustomApps function offers optimized default parameter settings for an extremely wide range of uses. This allows thermal imaging camera applications to be set quickly and safely for each specific use. Ten menu languages and a 1/4" tripod connection are also included.

General safety instructions

- The device must only be used in accordance with its intended purpose and within the scope of the specifications.
- The measuring tools and accessories are not toys. Keep out of reach of children.
- Modifications or changes to the device are not permitted, this will otherwise invalidate the approval and safety specifications.
- Do not expose the device to mechanical stress, extreme temperatures, moisture or significant vibration.
- The device must no longer be used if one or more of its functions fail or the battery charge is weak.
- Use only original accessories. Using other accessories invalidates the warranty.
- When using the device outdoors, make sure that the weather conditions are appropriate and/or that suitable protection measures are taken.
- Use the power supply/charger unit only in closed rooms; do not expose to moisture or rain otherwise risk of electric shock.
- The battery may only be charged with the power pack/charger and charging cradle provided and used only with this laser device. Any other use may cause injury or fire. The battery can also be charged directly in the device using the USB-C cable provided.
- Charge the device's battery completely prior to use.
- Make sure there are no conductive objects in the vicinity of the battery contacts. Short-circuiting of these contacts can cause burn injuries or fire.
- Do not open the rechargeable battery. This could cause short-circuits.
- The charging process is complete when the battery symbol with five stripes is permanently superimposed on the display.
- If the battery has a weak charge, the battery symbol is shown in red and a written warning appears in the display.
- Disconnect the power pack from the mains when the device is not in use.

ThermoCamera HighSense (Pro)

Safety instructions

Using electromagnetic radiation and RF wireless radiation

- Local operating restrictions – for example, in hospitals, aircraft, petrol stations or in the vicinity of people with pacemakers – may apply. Electronic devices can potentially cause hazards or interference or be subject to hazards or interference.
- The measuring accuracy may be affected when working close to high voltages or high electromagnetic alternating fields.
- The measuring device is equipped with a wireless interface.
- The measuring device complies with electromagnetic compatibility and wireless radiation regulations and limits in accordance with the RED 2014/53/EU.
- Umarex GmbH & CO. KG hereby declares that the ThermoCamera HighSense and ThermoCamera HighSense Pro radio equipment meets the specific requirements and other provisions of the European Radio Equipment Directive 2014/53/EU (RED). The complete texts of the EC declaration of conformity is available at the following internet address:
ThermoCamera HighSense: <https://packd.li/II/alf/in>
ThermoCamera HighSense Pro: <https://packd.li/II/alg/in>

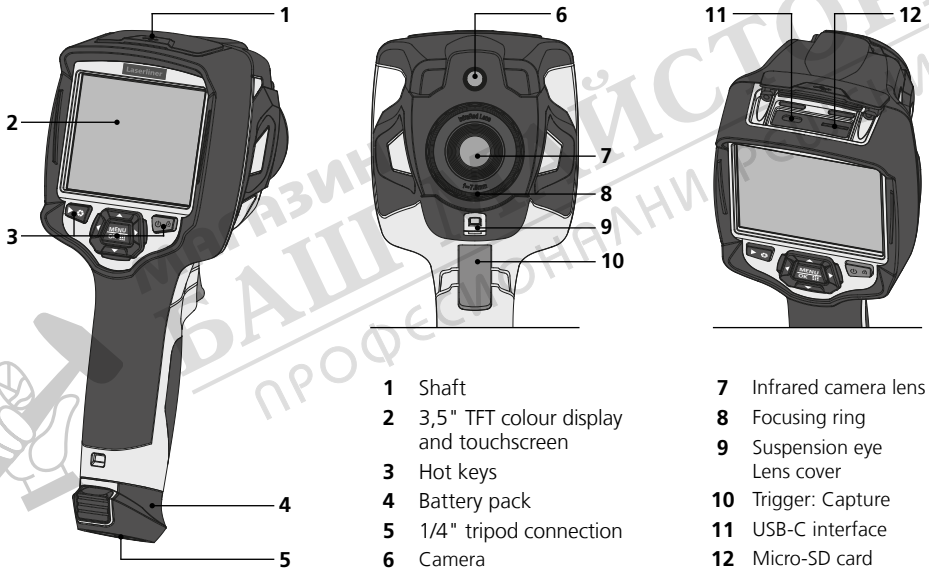

- a Media gallery / Shutter
- b Change temperature mode / ON/OFF
- c Hot keys / Manual IR calibration
- d Confirm/Next / CustomApps

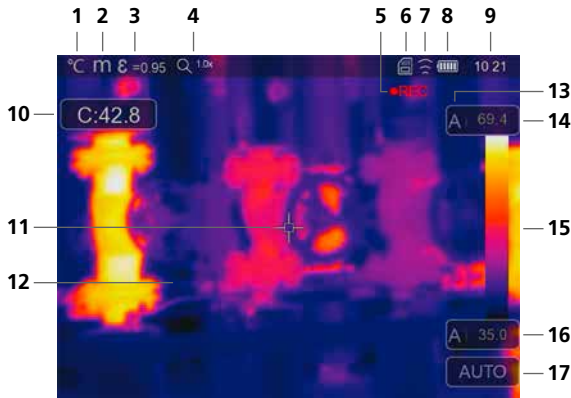

Standard measurement view

- 1 Temperature unit
- 2 Unit of distance
- 3 Set emissivity coefficient
- 4 Zoom factor
- 5 Video recording
- 6 Micro-SD card inserted
- 7 WLAN active
- 8 Battery charge indicator
- 9 Time
- 10 Centre point temperature
- 11 Centre point marking
- 12 Thermography image
- 13 Temperature range
- 14 Max. temperature
- 15 Colour spectrum with temperature range
- 16 Min. temperature
- 17 Select temperature mode

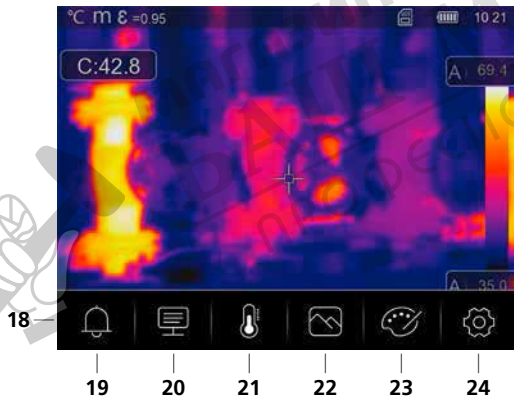

Main menu

- 18 Main menu
- 19 above/below alarm
- 20 Set parameter
- 21 Set measurement point
- 22 Set image
- 23 Change colour pallet
- 24 General and measurement-specific settings

ThermoCamera HighSense (Pro)

1 ON / OFF



ON



OFF

2 Charging the li-ion battery

To charge the Li-Ion battery pack, plug the supplied power supply/battery charger into charging socket „11“ and connect it to an appropriate power source. Operation while charging is possible.

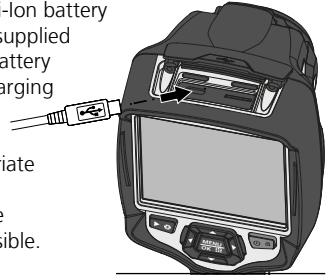

3 Inserting micro-SD card

To insert a micro-SD card, first open the rubber cover and then insert the memory card as illustrated.



! SD card prerequisite:
microSDHC, class 10, FAT32

4 Removing / inserting li-ion battery pack

Open battery compartment (12). Before removing the battery, switch off the device and disconnect it from the mains.



5 Main menu

General and measurement-specific settings can be made in the main menu. The menu is controlled directly or via the touchscreen.

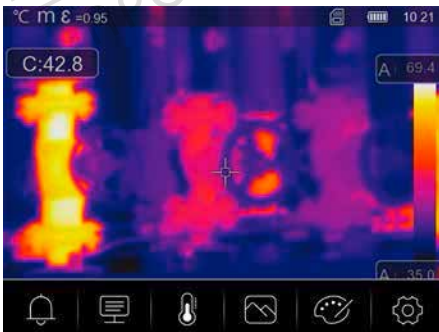



Alarm: Set the alarm above and below the specified temperature level.



Parameter: Before each use, check the relevant parameters for infrared measurement or adjust them to the specific measuring situation to ensure accurate measurements. In doing so, please pay particular attention to the general parameters with respect to the emissivity coefficient, distance to target and ambient conditions.



Measuring device: Set the measurement points and areas.



Image mode: Select image mode from IR Thermal, MIX Image, Visible image, Auto Fusion and Zoom.



Colour palettes: Several colour palettes are available to display the infrared temperatures.



Settings: Set language, temperature units, date, time, etc., display the WLAN connection, select CustomApps, automatic switch off and display information about the device.

6 Alarm: Below MIN / above MAX alarm



The alarm threshold values above and below the specified temperature levels can be set in this menu. Instructions for activating the alarm are provided in Section 14.3.

7.0 Parameter: Ambient temperature



Influences measurements taken with the thermal imaging camera are affected by the ambient temperature. This parameter compensates the influence of the ambient temperature on the measurement. This can be set between 0 °C and 50 °C.

ThermoCamera HighSense (Pro)

7.1 Parameter: Reflection temperature

Infrared measurements of specific objects can be affected by reflection from other objects nearby or even from the ambient air because the measured object cannot be fully isolated. The reflection temperature setting can help compensate for the interference. The reflection temperature is generally the same as the ambient temperature. However, if larger objects with significantly different temperatures (approx. $> 20\text{ }^{\circ}\text{C}$) are in close proximity to the measured area, its effects must be taken into account. For this purpose, follow these steps:



1. Set emissivity coefficient to 1.0
2. Blur the object out of focus (Refer to Section 15.1)
3. Aim the camera in the opposite direction of the actual measured object
4. Determine the average temperature
5. Set the average temperature as the reflection temperature

7.2 Parameter: Relative humidity



High humidity can lead to the lens of the thermal imaging camera misting over which means the infrared radiation is not fully received. The infrared radiation is absorbed on the way to the lens by the atmosphere and distributed by the water vapour suspended in the air, amongst other things (relative humidity). These influences should be taken into consideration, particularly when the distance to the measured object exceeds around 30 m. This can have a negative influence on the measuring accuracy. The parameter can be set from 10 % to 100 % to compensate for the influence of the relative humidity. Thick fog can also affect the measurement as the water droplets in the transmission path allow less infrared radiation through.

7.3 Parameter: Temp. Compensation

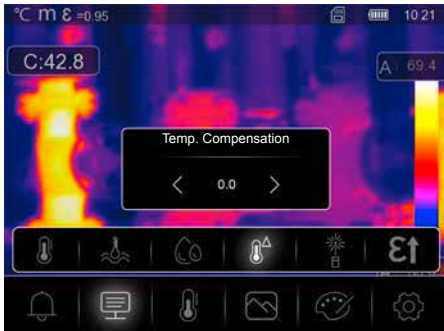

The temperature compensation can be set between $-5.0\text{ }^{\circ}\text{C}$ and $+5.0\text{ }^{\circ}\text{C}$.

7.4 Parameter: Distance



Air contains many different substances which can absorb infrared rays. The infrared radiation from the inspected object therefore decreases as the distance increases. At distances greater than 10 metres, the atmospheric influences of the air must always be taken into account. The distance can be set between 0 and 2,000 m.

7.5 Parameter: Emissivity



The level of infrared emissions given off by everything depends on the specific material and surface. This factor is determined by the emissivity coefficient (0.10 ... 1.0). For accurate measurements, it is absolutely essential that the emissivity coefficient is set first. The emissivity coefficient can either be custom set or selected based on the predefined emissivity coefficients from the material list.

ThermoCamera HighSense (Pro)

Emissivity table (reference values with tolerances)







Metals			
Alloy A3003		Iron	
Oxidised	0.20	Oxidised	0.75
Roughened	0.20	With rust	0.60
Aluminium		Iron, cast	
Oxidised	0.30	Non-oxidised	0.20
Polished	0.05	Molten mass	0.25
Brass		Iron, forged	
Polished	0.30	Matt	0.90
Oxidised	0.50	Lead	
Chromium oxide	0.81	Rough	0.40
Copper		Platinum	
Oxidised	0.72	Black	0.90
Copperoxide	0.78	Steel	
Inconel		Cold rolled	0.80
Oxidised	0.83	Ground plate	0.50
Electropolished	0.15	Polished plate	0.10
		Steel	
		Alloy (8% nickel, 18% chromium)	0.35
		Galvanised	0.28
		Oxidised	0.80
		Heavily oxidised	0.88
		Freshly rolled	0.24
		Rough, flat surface	0.96
		Rusty, red	0.69
		Sheet, nickel plated	0.11
		Sheet, rolled	0.56
		Stainless steel	0.45
		Zinc	
		Oxidised	0.10

Nonmetals			
Asbestos	0.93	Gravel	0.95
Asphalt	0.95	Grit	0.95
Basalt	0.70	Gypsum	0.88
Brick, red	0.93	Gypsum cardboard	0.95
Carborundum	0.90	Heat sink	
Cement	0.95	Black, anodized	0.98
Ceramics	0.95	Human skin	0.98
China		Ice	
Brilliant white	0.73	Clear	0.97
With glaze	0.92	With heavy frost	0.98
Clay	0.95	Laminate	0.90
Coal		Lime	0.35
Non-oxidised	0.85	Lime malm brick	0.95
Concrete, plaster, mortar	0.93	Limestone	0.98
Cotton	0.77	Marble	
Earthenware, matt	0.93	Black, dull finish	0.94
Fabric	0.95	Greyish, polished	0.93
Glass	0.90	Masonry	0.93
Glass wool	0.95	Paint	
Graphite	0.75	Black, matt	0.97
		Heat-resistant	0.92
		White	0.90
		Paper	
		All colours	0.96
		Plastic	
		Translucent	0.95
		PE, P, PVC	0.94
		Quartz glass	0.93
		Rubber	
		Hard	0.94
		Soft, grey	0.89
		Sand	0.95
		Screed	0.93
		Snow	0.80
		Soil	0.94
		Tar	0.82
		Tar paper	0.92
		Transformer paint	0.94
		Wallpaper, light-coloured	0.89
		Water	0.93
		Wood	
		Untreated	0.88
		Beech, planed	0.94

! A simplified table for the emissivity coefficient is available from the Measurement Settings menu under Emissivity Coefficient.

! Before each use, check the settings for infrared measurement and adjust them to the respective measuring situation to ensure accurate measurements. Pay particular attention to the general parameters for the emissivity coefficient and the reflection temperature.

8 Set measurement

-  **Center point:** Measure the temperature in the centre of the image area.
-  **Measure point:** Measure the temperature at a manually determined point. A maximum of three measuring points are available.
-  **Hot/Cold:** Measure maximum and minimum temperature.
-  **Area:** Measure the temperature in a manually determined area. A maximum of three measuring areas are available.
-  **Line:** Measure the temperature along a horizontal or vertical line in the display. Both lines can be moved. Particularly small temperature differences along the line of measurement are indicated graphically by the line display.
-  **Delete:** Delete all measuring settings.

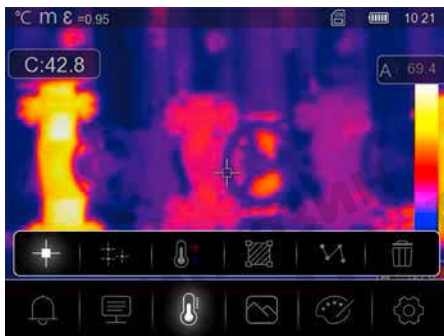

9.0 Set image

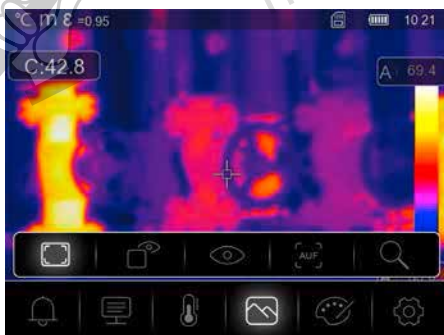

There are five different image modes for display: IR Thermal, MIX Image, Visible image, Auto Fusion, Zoom.

ThermoCamera HighSense (Pro)

9.1 Image: IR Thermal

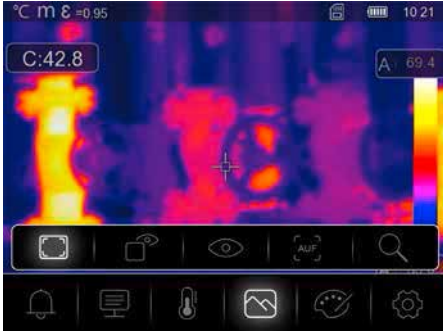

In **IR Thermal** mode, only the infrared image is shown.

9.2 Image: MIX Image



In **MIX Image** mode, a detail from the infrared image is displayed in the digital image.

9.3 Image: Visible image



In **Visible image** mode, the digital image is displayed.

9.4 Image: Auto Fusion



In **Auto Fusion** mode, the digital image and infrared image are overlaid. This allows the location of the relevant infrared areas to be quickly and precisely identified. The temperature in the central area is compared to the digital image. The mix ratio between the infrared image and the digital image can be adjusted manually. The detail of the overlaid area occupies approximately half the display area and is placed centrally but can be moved to a specific position using the touchscreen.

9.5 Image: Zoom

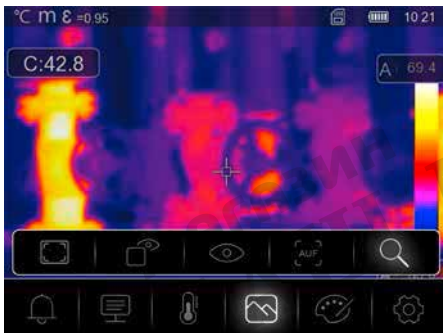

In **zoom** mode, the viewed area can be magnified by a factor of 32.

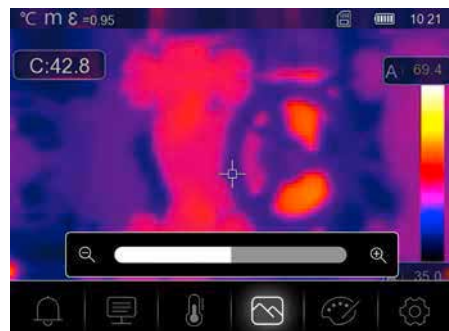
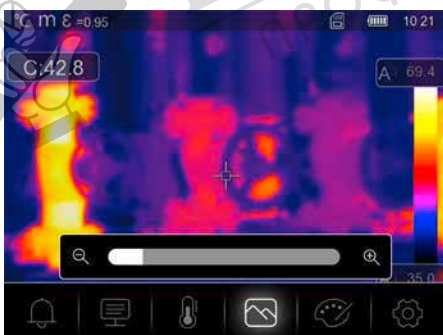

ThermoCamera HighSense (Pro)

10.0 Set palette



Eight standard palettes and four special palettes are available to display the captured infrared temperatures. The choice of palette allows the false colour display of the infrared images displayed or taken to be modified. The measured temperatures are adjusted within the current image section and displayed in the respective colour space. The bargraph for the respective minimum/maximum temperatures serves as a reference for the temperature and colour mapping. The standard palettes provide a smooth and linear reproduction.



Iron



Rainbow



Grey scale



Grey Inverted



Brown Hot



Blue/Red



Hot/Cold



Feather

10.1 Palette: Above MAX alarm



Areas with a temperature that exceeds the threshold set for the upper temperature are shown in red.

10.2 Palette: Below MIN alarm



 Areas with a temperature that falls below the threshold set for the lower temperature are shown in blue.

10.3 Palette: Interval alarm

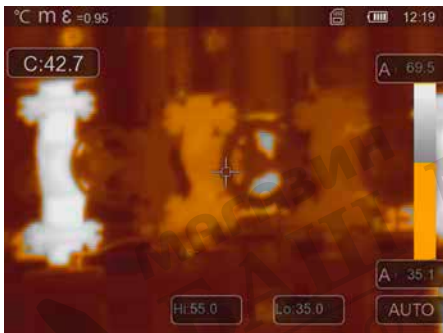

 Areas with a temperature within the threshold set for the upper and lower temperatures are shown in orange.

10.4 Palette: Visible zone

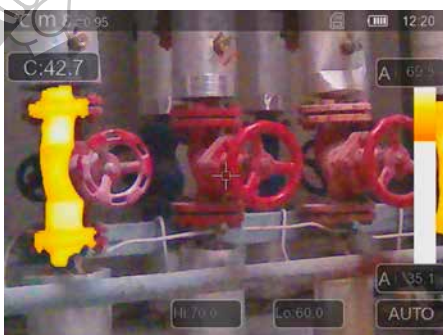

 Areas with a temperature within the threshold set for the upper and lower temperatures are shown using the palette. The other areas in the image are shown as a digital image.

11 Temperature mode: Automatic, Manual and Histogram mode

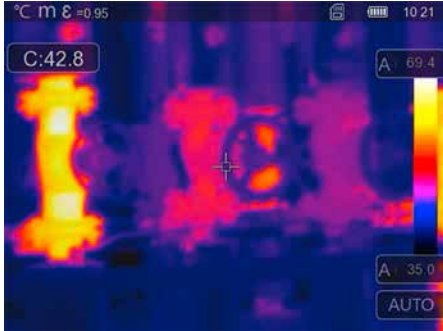

A In Automatic mode, the measured temperature range of the infrared image and the resultant distribution of the colour spectrum are permanently set. The colour spectrum of the measured infrared image is determined by the temperature range and colour scale. The colour distribution of the infrared image is automatically and dynamically adjusted in the bargraph based on the measured min./max. values.

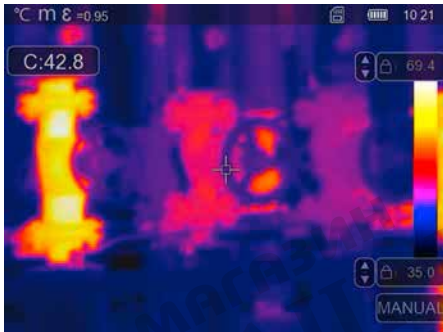

🔒 In manual settings mode, the temperature range is no longer set automatically based on the measured min./max. values but rather determined on the basis of manual values.



H In Histogram mode, the colour distribution of the infrared image is adjusted in the same way as in Automatic mode. In addition, a statistical analysis of the temperature distribution in the infrared image (histogram) stabilises the min./max. values. If the temperatures vary significantly, this stabilises the view from one image to the next, e.g. when measuring moving objects

! The min/max values last measured are taken as the default setting every time the temperature range is switched from histogram (HG) to manual (MANUAL). Procedure when measuring in Manual temperature mode. For quick localisation and inspection of the relevant measuring positions, view the measured object in Automatic mode and determine the optimum measuring position in which the min/max temperature range approximately corresponds to the required temperature range. Once the min/max values have stabilised, select Manual mode without changing position to transfer the current values as a default setting using button (b).

12 Settings

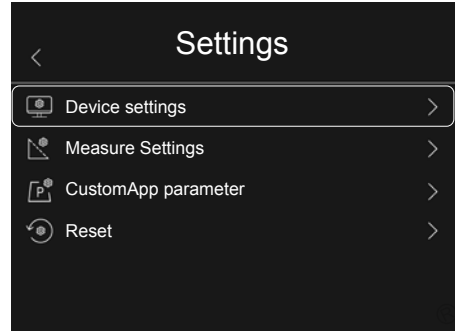
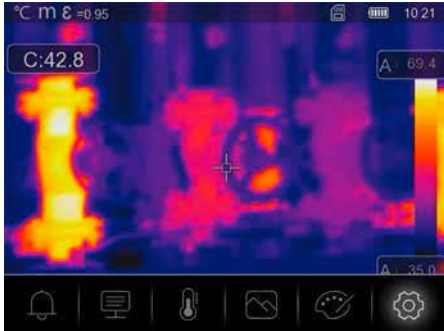

13.0 Device settings: USB Mode

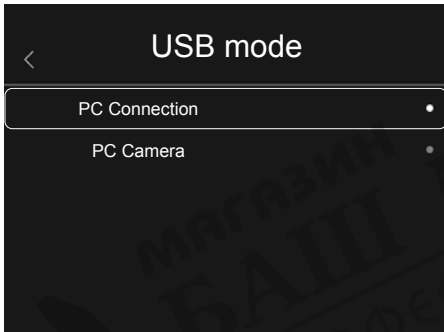

The data recorded by the thermal imaging camera can be transferred to a PC in USB mode. To allow several people to view the image on the camera at the same time, the PC can be used for live transmission. The USB drive must be correctly removed from the PC after use to avoid read errors on the PC.

13.1 Device settings: Brightness

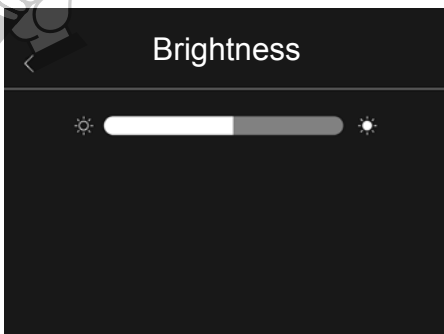

The screen brightness can be adjusted using the slider.

ThermoCamera HighSense (Pro)

13.2 Device settings: WiFi

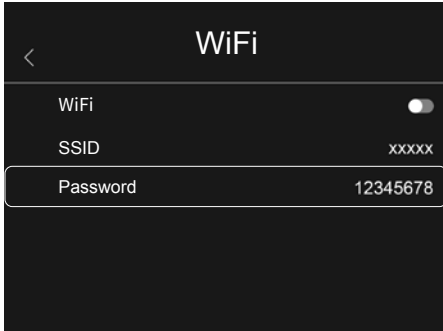

A connection to the device can be established via WiFi. The default SSID is 'TCHS' or 'TCHS Pro' and the default password is '12345678'. Data on the camera can be accessed using the Laserliner HighSense app once a connection is made.

13.3 Device settings: Date/Time

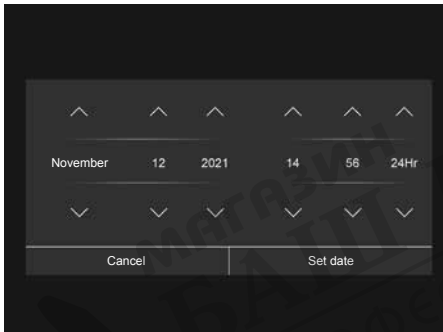

The time and date can be adjusted using the arrow buttons.

13.4 Device settings: Language

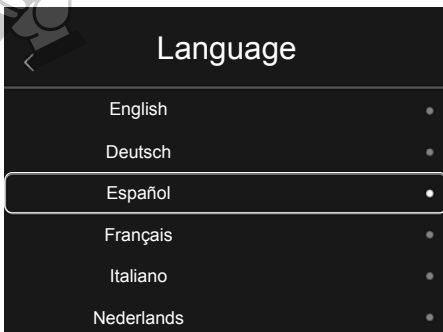

The preferred language can be set in this menu.

13.5 Device settings: Auto Power Off

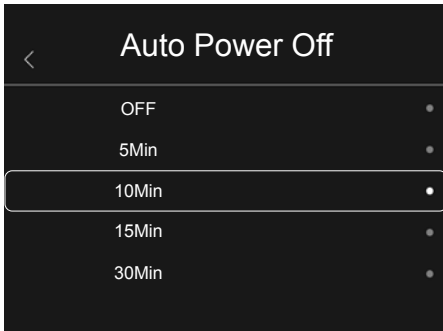

The device switches off automatically after the set period of inactivity. The time is stopped by touching the screen or pressing a button.

13.6 Device settings: About

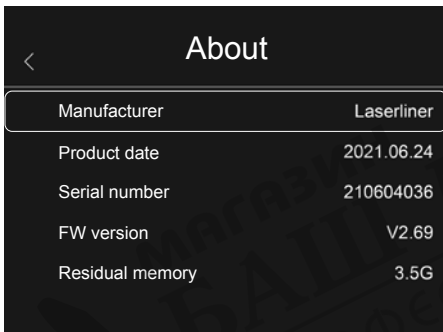

This menu provides information on the product.

14.0 Measure Settings: Distance unit

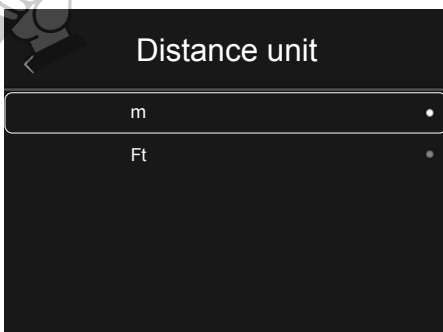

The unit of distance can be set in this menu.

ThermoCamera HighSense (Pro)

14.1 Measure Settings: Temperature unit

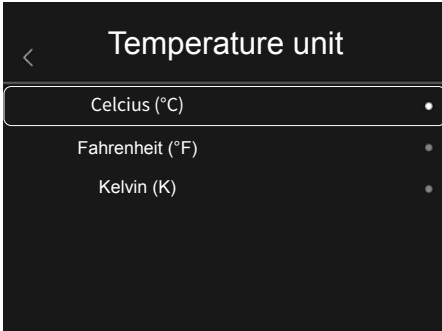

The unit of temperature can be set in this menu.

14.2 Measure Settings: Temperature range

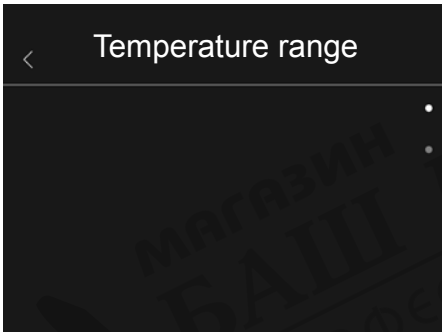

The default setting for the temperature range can be selected in this menu. Choose between two ranges: -20 - +150 °C (optimum for indoor and outdoor thermal imaging of buildings) 0 - +650 °C (optimum for industrial applications)

14.3 Measure Settings: Alarm mode

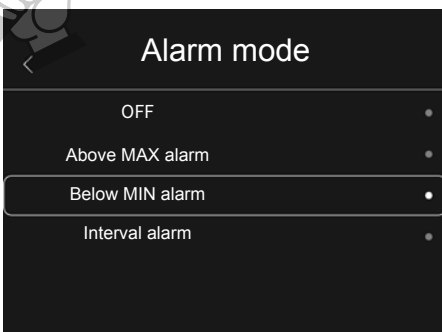

The upper and low alarm levels can be activated in the Alarm Mode menu.

The upper and lower alarm levels must be activated to use the Alarm Range function.

The Alarm Range is defined by the threshold values for the upper and lower alarm levels. The acoustic alarm sounds if a temperature is measured which is within these two threshold values, for example when the temperature is 35 °C and the upper alarm is set at 40 °C and the lower alarm at 30 °C.

14.4 Measure Settings: Image Align

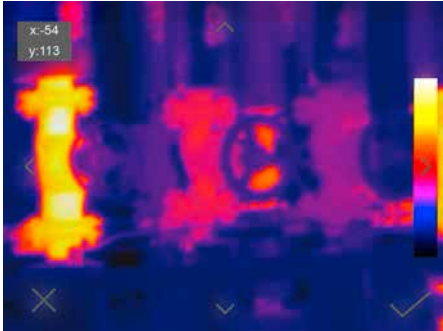

The digital image and infrared image can be aligned to each other using the arrow keys.

15 Reset

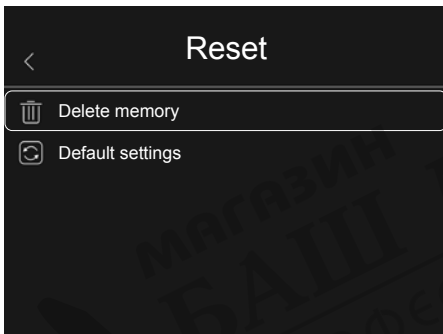

The current media gallery can be deleted by selecting '**Delete memory**'. All previous settings can be deleted by selecting '**Default settings**'. We recommend formatting the SD card directly on a PC using FAT32 Format.

15.0 Camera: Menu

The device features an image and video function. Images are saved as JPG and HIR files and also include the radiometric measurement data as well as the infrared/digital image. Videos are saved as MP4 files and include the infrared data of the recording.

15.1 Camera: Focus and shutter

In addition to the basic settings in the measuring device, the camera focus and shutter function play an essential role in achieving high-quality thermography results. Bring the measured object into the best possible focus so that the outlines and contours are clearly visible on the display. Do not touch the lens. The image can be calibrated either manually or automatically. Manual calibration is activated by holding down button (a). Automatic calibration is performed, after a period of time, to keep the IR image sensor cyclically in the highest accuracy range.

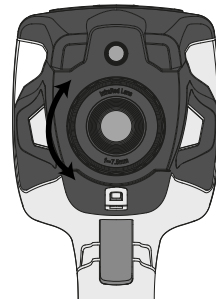

ThermoCamera HighSense (Pro)

15.2 Camera: Capture image

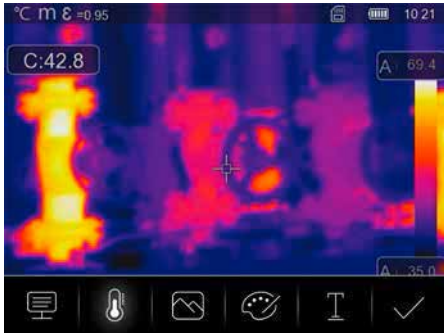

Pressing the trigger freezes the image and the save menu appears. The shot can be edited in the save menu before it is saved. There is an option for adding text comments. Pressing the text notes symbol opens an editor with a keyboard. Use the tick symbol to close the editor after entering the text.

15.3 Camera: Video capture



Pressing the trigger for a minimum of two seconds starts video capture. To end and save the video, press the trigger again.

15.4 Camera: Media gallery

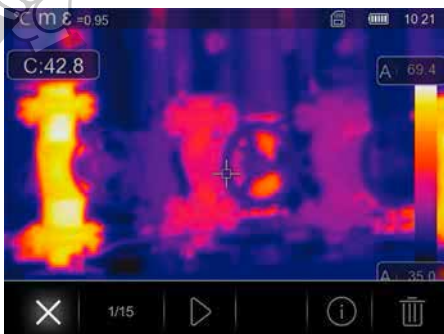

You can access, play, and manage all of the images and videos recorded with the thermal imaging camera in the media gallery. Call up the media gallery using the left hot key.

16.0 CustomApps: Menu



One-click configuration allows the device to be configured quickly using the CustomApp function for a wide range of standard applications, even with extensive parameter setups. CustomApps can be accessed by pressing the menu hot key for 2 seconds or from the Settings menu. Further information on CustomApps is available here:



<https://packd.li/ll/ca2/ap/wi>

16.1 CustomApps: Factory Settings

All parameters are reset to the default factory settings, the language settings remain the same. Due to the number of parameters and the subsequent possibility of entering incorrect information, it is advisable to reset the the camera to the default settings before every important measurement. This allows parameters to be entered from a known starting point.

16.2 CustomApps: ColdView-Inspection



ColdView-Inspection is suitable for detailed examination of cold areas. Problem points such as thermal bridges, cold air flows or air leakages, such as around window frames or doors, can be identified quickly and accurately. The MIX image overlays the digital image on the coldest 20 % of the temperature range captured on site. The condensed colour palette provides an optimum visualisation of the precise extreme temperature points. A standard colour palette can be used for subsequent temperature measurement of the extremes in order to produce a balanced colour image for measurement and evaluation. The centre point (P1) provides direct temperature measurement.

16.3 CustomApps: HotView-Inspection

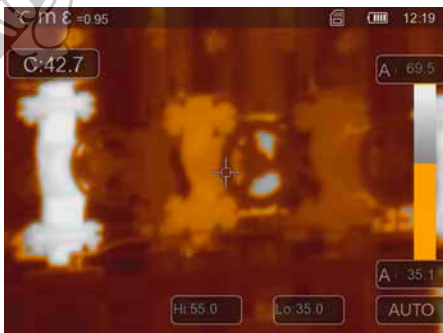

HotView-Inspection is suitable for detailed examination of hot areas and determination of points with predominantly high temperatures. These include heating pipes, fuses and electrical connections. The MIX image overlays the digital image on the warmest 20 % of the temperature range captured on site. The condensed colour palette provides an optimum visualisation of the precise extreme temperature points. A standard colour palette can be used for subsequent temperature measurement of the extremes in order to produce a balanced colour image for measurement and evaluation. The centre point (P1) provides direct temperature measurement.

16.4 CustomApps: Alarm high



Alarm high provides point measurement of temperatures and emits an acoustic alarm when the upper threshold value is exceeded. Set the threshold value (Section 6, Setting the alarm) to suit the application. All other parameters have already been set. Check the function on a hot item before measuring the temperature. Applications include checking temperature threshold values in production areas and determining overheated areas in buildings. Overheated components in machines and vehicles can also be identified, for example, brakes on lorries. To ensure stable measuring conditions, the best option is to use a tripod.

16.5 CustomApps: Alarm low

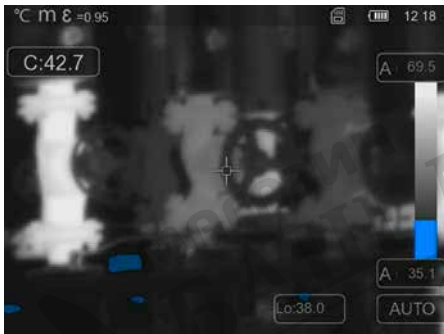

Alarm low provides point measurement of temperatures and emits an acoustic alarm when the value falls below the lower threshold value. Set the threshold value (Section 6, Setting the alarm) to suit the application. All other parameters have already been set. Check the function on a cold item before measuring the temperature. Applications include quick identification of areas in buildings where the temperature is too low and checking air conditioning systems. To ensure stable measuring conditions, the best option is to use a tripod.

16.6 CustomApps: FeverDetection



FeverDetection allows people running a temperature to be identified, perfect for a quick check before starting work. The temperature is to be taken at head level.

The forehead of the person being checked acts as the measuring point. Skin temperature is usually less than the actual body temperature due to the cooling effects of air and is taken into consideration in the alarm setting. Infrared measurement of skin temperature can be affected by a range of factors and may vary much more than in other measuring methods. Factors include the ambient temperature, skin type, skin hydration, cosmetics and creams. It is therefore important to make sure you take the measurement out of the wind and the measuring point is as dry and free of products as possible. If the threshold temperature is exceeded, the device produces an acoustic alarm which should indicate a raised temperature. The visual marker for fever is also shown on the display. For precise adjustment of the body temperature difference and the tolerances, the temperature compensation (offset) can be adjusted (see 7.3) to increase the measuring accuracy, for example, use a water bath set to a precise temperature (35 °C) and adjust the offset until the display shows a temperature of 36.5 °C.

16.7 CustomApps: HighSense



HighSense is suitable for precise measuring of the mean temperature on large, evenly heated, flat areas such as walls. Determining the mean value allows more accurate and reliable measurement results to be achieved than with a single point measurement. There must be no visible hot or cold spots during the measurement and the entire image area should be heated as evenly as possible. To avoid the measuring area being displaced during measurement, make sure the thermal imaging camera is secure. The best option is to use a tripod.

The mean temperature determined is then displayed as the AVG (mean temperature) for the entire area measured.

ThermoCamera HighSense (Pro)

16.8 CustomApps: SenseLine

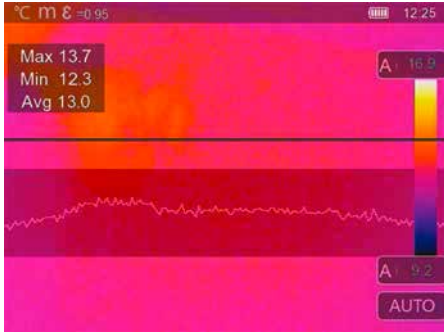

SenseLine provides a visualisation of the temperature curve. Small temperature differentials can be quickly identified in the area under examination. The measurement is taken along the horizontal base line. The maximum, minimum and mean temperatures are also indicated. Objects which are difficult to identify visually, such as underfloor heating, can be easily identified using the temperature curves as the curve rises and falls at the edges of the object.

17 Software for Windows desktop PC

The software available online allows the recorded data to be transferred to a PC and used for further processing and documentation. Download the software and follow the installation instructions.

<https://packd.li/ll/qrplus/ap/wi>



It is not necessary to install a driver. The software operates under Windows 10 and 11.

1.

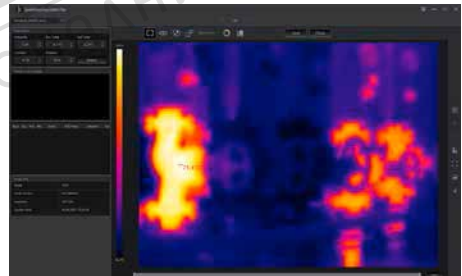
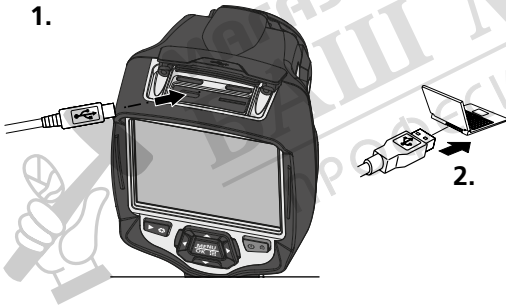

18 Laserliner HighSense App (optional)

The HighSense app provides easy viewing and documentation of the measured results. Switch on the WiFi interface on the thermal imaging camera and connect to the smart phone. App functions include viewing videos in real time as well as taking and saving screen shots. It is also possible to make text notes, export pdf reports, view image information, and delete images. <https://packd.li/ll/hs/ap>



There is also a Help function to help with using the app.

Fault diagnosis

If problems occur when using the thermal imaging camera, take the following steps as shown in the table below. Should the problem persist, please contact the UMAREX Laserliner service department.

Error	Reason	Solution
Device does not start	No battery / battery depleted	Insert / charge battery
Device switches off suddenly	No power	Charge battery
No heat image	Lens cover on the device	Remove lens cap

Information on maintenance and care

Clean all components with a damp cloth and do not use cleaning agents, scouring agents and solvents. Remove the battery(ies) before storing for longer periods. Store the device in a clean and dry place.

Calibration

The measuring device must be calibrated and tested on a regular basis to ensure it is accurate and working properly. We recommend carrying out calibration once a year. Contact your distributor or the UMAREX-LASERLINER service department.

ThermoCamera HighSense (Pro)

Technical data		Subject to technical alterations. (22W25)	
	ThermoCamera HighSense	ThermoCamera HighSense Pro	
Sensor type	uncooled microbolometer		
Infrared temperature resolution	160 x 120 pixels	384 x 288 pixels	
Resolution display	640 x 480 pixels		
Field of view (FOV)	20.7° x 15.6°	41.5° x 31.1°	
Spatial resolution (IFOV)	2,26 mrad	1,89 mrad	
Focus	adjustable		
Shutter Period	Auto, 1 min, 3 min, 5 min, 10 min, 15 min, 30 min, Off		
Thermal sensitivity (NETD)	< 50 mK @30°C		
Measurement range / Precision	-20°C ... 150°C, 0°C ... 650°C / ± 2°C or 2% of measured value		
Screen type	3.5" colour TFT		
Mode	Infrared image, digital image, MIX image, image-in-image		
Image function	1-32x digital zoom		
Image-/Videoformat	JPEG / MPEG-4		
Memory	Micro-SD card up to 8 GB		
Ports	USB type C, 1/4" tripod thread		
Radio module operating data	WLAN standard: IEEE 802.11 b/g/n; Frequency band: 2.400 - 2.4835 GHz (IEEE 802.11 b/g/n); Radio channels: Channel 9; Transmit power: 17 dBm max.; Transmission rate: IEEE 802.11 b to 11 Mbps, IEEE 802.11 g/n to 54 Mbps (at 15 ± 2 dBm); Safety: open; Local server mode: IP address 192.168.230.1, HTTP, no DHCP; Port: 80		
Operating conditions	-15°C ... 50°C, humidity 10 ... 90% rH, no condensation, max. working altitude 2000 m above sea level		
Storage conditions	-20°C ... 70°C, humidity 10 ... 99% rH		
Power supply / Charging time / Operating time	Li-Ion pack battery 3,7V / 2,6Ah / 9,62Wh approx. 4 h. / approx. 4 h		
Dimensions (W x H x D) / Weight	95 x 230 x 112 mm / 530 g (incl. battery pack)		

EU and UK directives and disposal

This device complies with all necessary standards for the free movement of goods within the EU and the UK.

This product is an electric device and must be collected separately for disposal according to the European and UK Directive on waste electrical and electronic equipment.

Further safety and supplementary notices at:

<https://www.laserliner.com>



**FR**

Cet appareil,
ses accessoires,
cordons et batteries
se recyclent

À DÉPOSER
EN MAGASINÀ DÉPOSER
EN DÉCHÈTERIE

OU

Points de collecte sur www.quefairedemesdechets.fr
Privilégiez la réparation ou le don de votre appareil !



МАГАЗИН
БАШ МАЙСТОРА
ПРОФЕСИОНАЛНИ РЕШЕНИЯ

**SERVICE****Umarex GmbH & Co. KG**

– Laserliner –

Möhnestraße 149, 59755 Arnsberg, Germany

Tel.: +49 2932 638-300, Fax: +49 2932 638-333

info@laserliner.com

Umarex GmbH & Co. KG

Donnerfeld 2

59757 Arnsberg, Germany

Tel.: +49 2932 638-300, Fax: -333

www.laserliner.com