

INSTRUCTION MANUAL

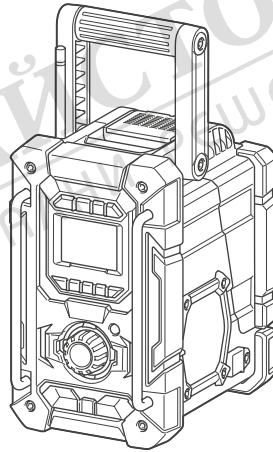

# Job Site Charger Radio

**DMR300**  
**DMR301**



Read before use.

# SPECIFICATIONS

Model:		DMR300	DMR301
AC power adaptor		DC 24 V / 5.0 A, inner sleeve positive	
Battery		UM-3 (AA size) x 2 for back up CXT battery: DC 10.8 V - 12 V max LXT battery: DC 14.4 V - 18 V	
Band		FM AM	FM AM DAB
Frequency coverage		<b>For European countries:</b> 50 KHz (0.05 MHz/step) <b>For countries other than Europe:</b> Refer to the nameplate on the radio for the frequency coverage. (The frequency coverage varies depending on the countries.)	
Bluetooth®	Bluetooth® Bluetooth® QD ID	147189 (The Bluetooth® word mark and logos are registered trademarks owned by Bluetooth SIG, Inc.)	
	Bluetooth® version	5.0 Certified	
	Bluetooth® profiles	A2DP / AVRCP	
	Transmission power	Power Class2	
	Operating Frequency	2,402 MHz - 2,480 MHz	
	Maximum radio-frequency power	6.32 dBm (Declaration for EU Compliance)	
	Transmission range	Optimum: Max.10 meters Possible: Max.30 meters (varies according to usage conditions)	
	Supported codec	SBC	
Circuit feature Loudspeaker		3.5 inches 8 ohm x 2	
Output Power		DC 10.8 V - 12 V max: 1.2 W x 2 DC 14.4 V: 2.2 W x 2 DC 18 V: 3.5 W x 2	
USB output		USB TYPE A x 2 (5 V / 2.4 A TOTAL)	
Battery charge output		CXT battery: DC 10.8 V - 12 V max, 3.5 A LXT battery: DC 14.4 V - 18 V, 3.5 A	
Input terminal		3.5 mm dia. (AUX IN1/AUX IN2)	
Antenna system		FM: soft bended rod antenna AM: bar antenna	
Dimension (L x W x H)		268 x 185 x 305 mm	
Weight (without battery cartridge)		5.9 kg	

- Due to our continuing program of research and development, the specifications herein are subject to change without notice.
- Specifications may differ from country to country.



The Bluetooth® word mark and logos are registered trademarks owned by the Bluetooth SIG, Inc. and any use of such marks by Makita is under license. Other trademarks and trade names are those of their respective owners.

The following table indicates the operating time on a single charge in Radio mode.

Battery capacity	Battery Cartridge Voltage			Operating time (hour) (at speaker output = 50 mW + 50 mW)		Charging time (min)
	10.8 V - 12 V max	14.4 V	18 V	In radio or AUX	In Bluetooth® with USB charging	
1.5 Ah	BL1016	-	-	6.3	0.9	31
	-	BL1415N	-	5.6	1.0	27
	-	-	BL1815N	6.1	1.4	27
2.0 Ah	BL1021B	-	-	8.2	1.2	40
	-	-	BL1820B	8.2	1.8	38
3.0 Ah	-	BL1430B	-	9.4	1.7	48
	-	-	BL1830B	11.3	2.5	48
4.0 Ah	BL1041B	-	-	16.4	2.3	75
	-	-	BL1840B	16.0	3.6	67
5.0 Ah	-	-	BL1850B	20.5	4.6	84
6.0 Ah	-	BL1460B	-	19.5	3.6	100
	-	-	BL1860B	24.7	5.5	100

**⚠ WARNING:** Only use the battery cartridges listed above. Use of any other battery cartridges may cause injury and/or fire.

**NOTE:** Some of the battery cartridges listed above may not be available depending on your region of residence.

**NOTE:** Table regarding to the battery operating time above is for reference. The actual operating time may differ with the type of the battery, charging condition, or usage environment.

## Symbols

The followings show the symbols used for the equipment. Be sure that you understand their meaning before use.



Read instruction manual.



Only for EU countries  
Do not dispose of electric equipment or battery pack together with household waste material!  
In observance of the European Directives, on Waste Electric and Electronic Equipment and Batteries and Accumulators and Waste Batteries and Accumulators and their implementation in accordance with national laws, electric equipment and batteries and battery pack(s) that have reached the end of their life must be collected separately and returned to an environmentally compatible recycling facility.

## EC Declaration of Conformity

### For European countries only

The EC declaration of conformity is included as Annex A to this instruction manual.

## SAFETY WARNINGS

### IMPORTANT SAFETY INSTRUCTIONS

### SAVE THESE INSTRUCTIONS.

**⚠ WARNING:** When using electric tools, basic safety precautions should always be followed to reduce the risk of fire, electric shock, and personal injury, including the following:

1. Read this instruction manual carefully before use. If you use a Makita charger, also read the charger instruction manual.
2. Clean only with dry cloth. Do not use water for cleaning.
3. Do not install near any heat sources such as radiators, heat registers, stoves, or other apparatus (including amplifiers) that produce heat.
4. Only use attachments/accessories specified by the manufacturer.
5. Unplug this appliance during lightning storms or when unused for long periods of time.
6. The battery pack must be recharged only with this radio or the specified charger for the battery. A charger that may be suitable for one type of battery may create a risk of fire when used with another battery.

7. Use battery operated radio only with specifically designated battery packs. Use of any other batteries may create a risk of fire.
8. When battery pack is not in use, keep it away from other metal objects like: paper clips, coins, keys, nails, screws, or other small metal objects that can make a connection from one terminal to another. Shorting the battery terminals together may cause sparks, burns, or a fire.
9. Avoid body contact with grounded surfaces such as pipes, radiators, ranges and refrigerators. There is an increased risk of electric shock if your body is grounded.
10. Under abusive conditions, liquid may be ejected from the battery; avoid contact. If contact accidentally occurs, flush with water. If liquid contacts eyes, additionally seek medical help. Liquid ejected from the battery may cause irritation or burns.
11. Do not use a battery pack and radio that is damaged or modified. Doing so may exhibit unpredictable behaviour resulting in fire, explosion or risk of injury.
12. Do not expose a battery pack or tool to fire or excessive temperature. Exposure to fire or temperature above 130 °C(266°F) may cause explosion.
13. Follow all charging instructions and do not charge the battery pack or tool outside the temperature range specified in the instructions. Charging improperly or at temperatures outside the specified range may damage the battery and increase the risk of fire.
14. The MAINS plug is used as the disconnect device. The MAINS plug shall remain readily operable.
15. Do not use the product at a high volume for any extended period. To avoid hearing damage, use the product at moderate volume level.
16. LCD displays include liquid which may cause irritation and poisoning. If the liquid enters the eyes, mouth or skin, rinse it with water and call a doctor.
17. Do not expose the product to rain or wet conditions. Water entering the product will increase the risk of electric shock.
18. This product is not intended for use by persons (including children) with reduced physical, sensory or mental capabilities, or lack of experience and knowledge, unless they have been given supervision or instruction concerning use of the product by a person responsible for their safety. Children should be supervised to ensure that they do not play with the product. Store the product out of the reach of children.
19. Be careful not to pinch your fingers when opening and closing the battery cover.
20. Return the battery compartment locker to the original position, after installing or removing battery pack. If not, battery pack may accidentally fall out of the radio, causing injury to you or someone around you.
21. Always close and lock the battery compartment locker before moving the radio.
22. When the radio is powered from the battery, switch off the radio before removing the battery pack.
23. Be careful not to drop or strike the radio. Broken shell may slash your finger or stab your body. Damaged radio may exhibit unpredictable behaviour resulting in fire, explosion or risk of injury.
24. Have servicing performed by a qualified repair person using only identical replacement parts. This will ensure that the safety of the product is maintained.
25. Do not modify or attempt to repair the appliance or the battery pack except as indicated in the instructions for use and care.

## Important safety instructions for battery cartridge

1. Before using battery cartridge, read all instructions and cautionary markings on (1) battery charger, (2) battery, and (3) product using battery.
2. Do not disassemble or tamper with the battery cartridge. It may result in a fire, excessive heat, or explosion.
3. If operating time has become excessively shorter, stop operating immediately. It may result in a risk of overheating, possible burns and even an explosion.
4. If electrolyte gets into your eyes, rinse them out with clear water and seek medical attention right away. It may result in loss of your eyesight.
5. Do not short the battery cartridge:
  - (1) Do not touch the terminals with any conductive material.
  - (2) Avoid storing battery cartridge in a container with other metal objects such as nails, coins, etc.
  - (3) Do not expose battery cartridge to water or rain.

A battery short can cause a large current flow, overheating, possible burns and even a breakdown.
6. Do not store and use the tool and battery cartridge in locations where the temperature may reach or exceed 50 °C (122 °F).
7. Do not incinerate the battery cartridge even if it is severely damaged or is completely worn out. The battery cartridge can explode in a fire.
8. Do not nail, cut, crush, throw, drop the battery cartridge, or hit against a hard object to the battery cartridge. Such conduct may result in a fire, excessive heat, or explosion.
9. Do not use a damaged battery.
10. The contained lithium-ion batteries are subject to the Dangerous Goods Legislation requirements. For commercial transports e.g. by third parties, forwarding agents, special requirement on packaging and labeling must be observed. For preparation of the item being shipped, consulting an expert for hazardous material is required. Please also observe possibly more detailed national regulations. Tape or mask off open contacts and pack up the battery in such a manner that it cannot move around in the packaging.

11. When disposing the battery cartridge, remove it from the tool and dispose of it in a safe place. Follow your local regulations relating to disposal of battery.
12. Use the batteries only with the products specified by Makita. Installing the batteries to non-compliant products may result in a fire, excessive heat, explosion, or leak of electrolyte.
13. If the tool is not used for a long period of time, the battery must be removed from the tool.
14. During and after use, the battery cartridge may take on heat which can cause burns or low temperature burns. Pay attention to the handling of hot battery cartridges.
15. Do not touch the terminal of the tool immediately after use as it may get hot enough to cause burns.
16. Do not allow chips, dust, or soil stuck into the terminals, holes, and grooves of the battery cartridge. It may result in poor performance or breakdown of the tool or battery cartridge.
17. Unless the tool supports the use near high-voltage electrical power lines, do not use the battery cartridge near high-voltage electrical power lines. It may result in a malfunction or breakdown of the tool or battery cartridge.
18. Keep the battery away from children.

## SAVE THESE INSTRUCTIONS.

**⚠ CAUTION:** Only use genuine Makita batteries. Use of non-genuine Makita batteries, or batteries that have been altered, may result in the battery bursting causing fires, personal injury and damage. It will also void the Makita warranty for the Makita tool and charger.

**⚠ CAUTION:** RISK OF EXPLOSION IF BATTERY IS REPLACED BY AN INCORRECT TYPE. Disposal of a battery into fire or a hot oven, or mechanically crushing or cutting of a battery, that can result in an explosion. Leaving a battery in an extremely high temperature surrounding environment that can result in an explosion or the leakage of flammable liquid or gas. A battery subjected to extremely low air pressure that may result in an explosion or the leakage of flammable liquid or gas.

## Tips for maintaining maximum battery life

1. Charge the battery cartridge before completely discharged. Always stop tool operation and charge the battery cartridge when you notice less tool power.
2. Never recharge a fully charged battery cartridge. Overcharging shortens the battery service life.
3. Charge the battery cartridge with room temperature at 10 °C - 40 °C (50 °F - 104 °F). Let a hot battery cartridge cool down before charging it.
4. Charge the battery cartridge if you do not use it for a long period (more than six months).

## Important safety instructions for battery charging

### CAUTION:

1. **SAVE THESE INSTRUCTIONS** – This manual contains important safety and operating instructions for battery charging.
2. Before charging, read all instructions and cautionary markings on this appliance, AC power adaptor, and battery cartridge.
3. **CAUTION** – To reduce risk of injury, charge only Makita type rechargeable batteries. Other types of batteries may burst causing personal injury and damage.
4. Non-rechargeable batteries cannot be charged with this appliance.
5. Use a power source with the voltage specified on the nameplate of the AC power adaptor.
6. Do not charge the battery cartridge in presence of flammable liquids or gases.
7. Do not expose the AC power adaptor to rain, snow, or wet condition.
8. Never carry the AC power adaptor by cord or yank it to disconnect from receptacle.
9. Before attempting any maintenance or cleaning, unplug the AC power adaptor and remove battery cartridge. Pull by plug rather than cord whenever disconnecting the appliance.
10. Do not leave the AC power adaptor disconnected from the appliance while the power is supplied from the mains.
11. Make sure cord is located so that it will not be stepped on, tripped over, or otherwise subjected to damage or stress.
12. Do not operate this appliance with damaged cord or plug. If the cord or plug is damaged, ask Makita authorized service center to replace it in order to avoid a hazard.
13. Do not operate or disassemble this appliance if it has received a sharp blow, been dropped, or otherwise damaged in any way; take it to a qualified serviceman. Incorrect use or reassembly may result in a risk of electric shock or fire.
14. Do not charge battery cartridge when room temperature is BELOW 10°C (50°F) or ABOVE 40°C (104°F). At the cold temperature, charging may not start.
15. Do not attempt to use the AC power adaptor with a step-up transformer, an engine generator or DC power receptacle.
16. Do not allow anything to cover or clog the vents on this appliance.
17. Do not plug or unplug the power cord and the AC power adaptor with wet hands.
18. Do not install or remove the battery cartridge with wet hands.

# INTRODUCTION

## Parts description

### Body

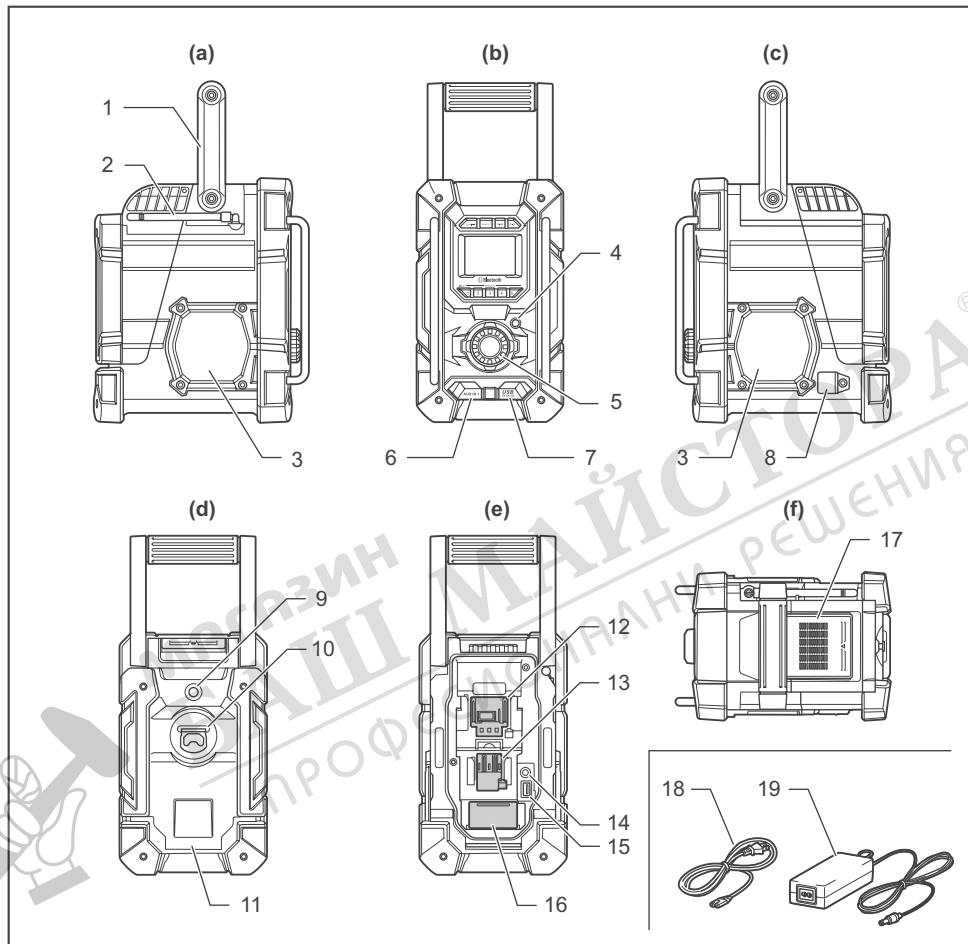

► a) Left side b) Front c) Right side d) Back (battery cover closed) e) Back (battery cover opened) f) Top

1	Handle	2	Soft bended rod antenna	3	Speaker	4	Menu/Info button
5	Volume/Tuning control/ Select knob	6	Auxiliary input socket (AUX IN 1)	7	USB power supply port	8	DC IN socket
9	Hook for AC adaptor	10	Bottle cap opener	11	Battery cover	12	Slot for LXT battery cartridge
13	Slot for CXT battery cartridge	14	Auxiliary input socket (AUX IN 2)	15	USB power supply port	16	Battery compartment (covering back up batteries)
17	Battery compartment locker	18	Power cord	19	AC power adaptor	-	-

## Buttons and LCD display

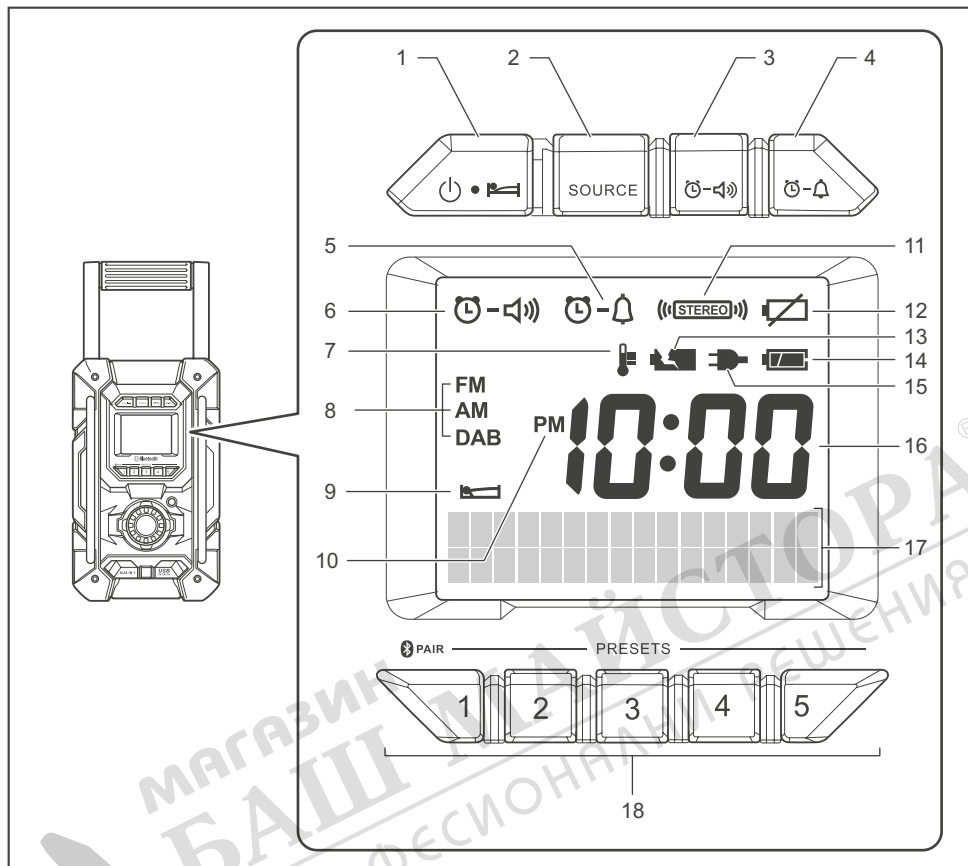

1	Power/Sleep timer button	2	Source button	3	Radio alarm button	4	Buzzer alarm button
5	"TIMER TO ALARM" icon	6	"TIMER TO SPEAKER" icon	7	Icon for delay charge	8	Band
9	Icon for sleep timer	10	PM indicator for clock	11	Stereo symbol	12	No power indicator
13	Error icon for charging failure	14	Indicator for battery status/capacity	15	Indicator for AC power supply	16	Clock
17	Information area	18	Preset stations/Presets 1 button as Bluetooth® pair button	-	-	-	-

**NOTE:** DAB is only receivable with DMR301.

## Installing back up batteries

**NOTE:** Keeping back up batteries inside the compartment prevent stored data in preset memories from being lost.

1. Pull up the battery compartment to unlock it and then open the battery cover.

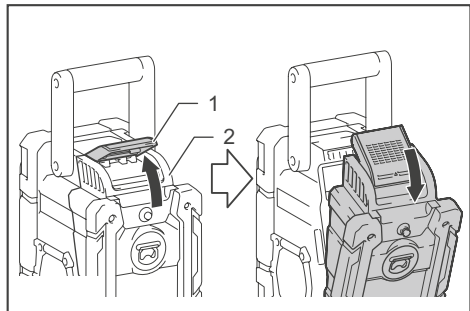

- 1. Battery compartment locker 2. Battery cover

2. Remove back up battery compartment cover and install 2 fresh UM-3 (AA sizes) batteries. Make sure the batteries are with correct polarity as shown inside the compartment.

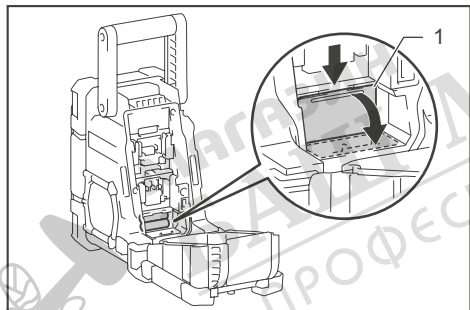

- 1. Back up battery compartment cover

3. Close the back up battery compartment cover.

## FUNCTIONAL DESCRIPTION

### Installing or removing battery cartridge

**CAUTION:** Hold the tool and the battery cartridge firmly when installing or removing battery cartridge. Failure to hold the radio and the battery cartridge firmly may cause them to slip off your hands and result in damage to the radio and battery cartridge and a personal injury.

Pull up the battery compartment to unlock it and then open the battery cover.

To install the battery cartridge, align the tongue on the battery cartridge with the groove in the housing and slip it into place. Insert it all the way until it locks in place with a little click. If you can see the red indicator on the upper side of the button, it is not locked completely.

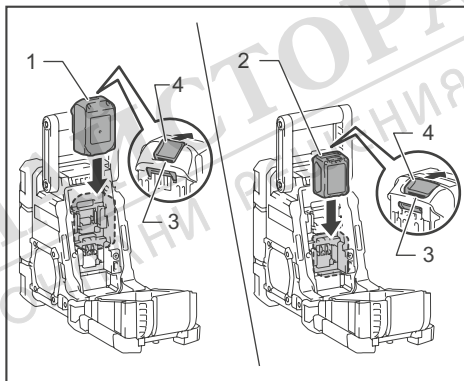

- 1. LXT battery cartridge 2. CXT battery cartridge  
3. Red indicator 4. Button

To remove the battery cartridge, slide it from the tool while sliding the button on the front of the cartridge. After installing/removing the battery cartridge, be sure to close the battery cover.

**CAUTION:** Always install the battery cartridge fully until the red indicator cannot be seen. If not, it may accidentally fall out of the tool, causing injury to you or someone around you.

**CAUTION:** Do not install the battery cartridge forcibly. If the cartridge does not slide in easily, it is not being inserted correctly.



## Indicating the remaining battery capacity

Only for battery cartridges with the indicator

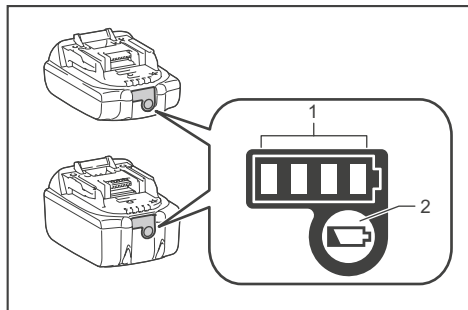

► 1. Indicator lamps 2. Check button

Press the check button on the battery cartridge to indicate the remaining battery capacity. The indicator lamps light up for a few seconds.

Indicator lamps			Remaining capacity
Lighted	Off	Blinking	
■ ■ ■ ■			75% to 100%
■ ■ ■ □			50% to 75%
■ ■ □ □			25% to 50%
■ □ □ □			0% to 25%
▬ □ □ □			Charge the battery. (For LXT battery only)
■ ■ □ □			The battery may have malfunctioned.
□ □ ■ ■			
	↑ ↓		(For LXT battery only)

**NOTE:** Depending on the conditions of use and the ambient temperature, the indication may differ slightly from the actual capacity.

## Using the soft bended rod antenna

When listening to FM radio stations, straight up the soft bended rod antenna as shown in the figure.

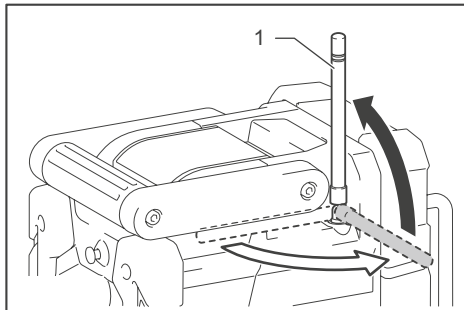

► 1. Soft bended rod antenna

**NOTICE:** Always store the soft bended rod antenna to the original position after use.

## Using Supplied AC power adaptor

**WARNING:** Always disconnect the AC power adaptor completely before moving the radio. If the AC power adaptor is not removed, it may cause an electric shock.

**WARNING:** Never pull and/or drag the cord of the AC power adaptor. If not, the radio may accidentally fall down, causing injury to you or someone around you.

**WARNING:** The AC power adaptor is used as the means of connecting the radio to the mains supply. The mains socket used for the radio must remain accessible during normal use.

**WARNING:** In order to disconnect the radio, the AC power adaptor should be removed from the mains outlet completely

**WARNING:** Use the AC power adaptor supplied with the product or specified by Makita only.

**WARNING:** Do not hold the power supply cable and plug by your mouth. Doing so might cause an electric shock.

**WARNING:** Do not handle the plug with wet or greasy hand.

**WARNING:** Damaged or entangled cords increase the risk of electric shock. If the cord is damaged, have it replaced by our authorized service center in order to avoid a safety hazard. Do not use it before repair.

**WARNING:** After use, always store AC power adaptor out of the reach of children.

Open the cover and insert the adaptor plug into the DC IN socket on the side of the radio. Plug the adaptor into a standard mains socket outlet. While the radio is powered from AC power adaptor, the indicator for AC power supply (➔) will appear on the display.

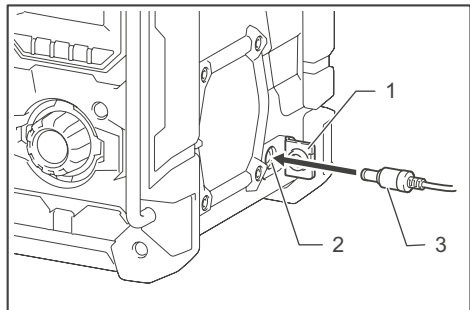

► 1. Cover 2. DC IN socket 3. Adaptor plug

**NOTE:** When the adaptor is used, the radio is powered from the mains and the battery cartridge is charged.

**NOTE:** When the radio has any interference in AM band by its AC adaptor, move the radio away from the AC adaptor further than 30 cm (1 feet).

## Auxiliary input socket

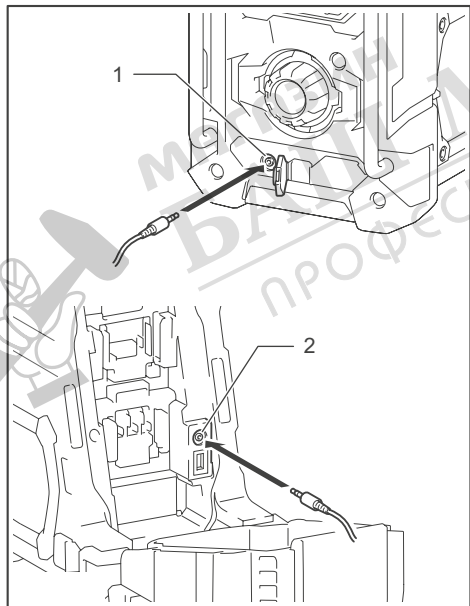

► 1. AUX IN 1 2. AUX IN 2

Two 3.5 mm stereo auxiliary input sockets are provided. One is at the front of the radio (AUX IN 1); the other is located in the battery compartment (AUX IN 2).

1. Connect an external audio source, such as a MP3 or CD player, to the auxiliary input socket.
2. Repeatedly press and release the Source button  until AUX IN 1 or 2 is displayed.

3. Adjust the volume setting on your external audio source to ensure an adequate signal level. After that, use the Tuning control knob  on the radio as needed for comfortable listening.

## Charging with USB power supply port

**CAUTION:** Do not connect power source to USB port. Otherwise there is risk of fire. The USB port is only intended for charging lower voltage device. Always place the cover onto the USB port when not charging the lower voltage device.

**CAUTION:** Do not insert a nail, wire, etc. into USB power supply port. Otherwise a circuit short may cause smoke and fire.

**NOTICE:** Before connecting USB device to the charger, always backup your data of USB device. Otherwise your data may lose by any possibility.

**NOTICE:** When not using or after charging, remove the USB cable and close the cover.

**NOTICE:** Do not connect this USB socket with your PC USB port, as it is highly possible that it may cause breakdown of the units.

**NOTE:** The charger may not supply power to some USB devices.

There are USB power supply ports at the front and back side of the radio. You can charge USB device through the USB power supply port.

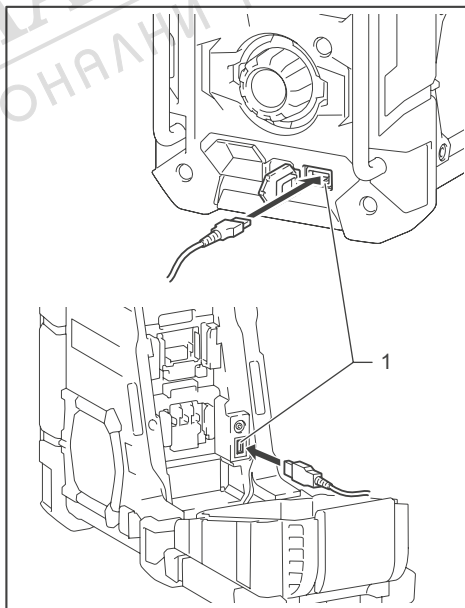

► 1. USB power supply port

1. Connect the USB device, such as a MP3 or CD player, to the USB power supply port using a USB cable available in the market.
2. Press the Power button  to switch on the radio.

**NOTE:** No matter if the radio is AC powered or battery powered, you can charge a USB device when the radio is switched on and in FM radio mode, Bluetooth mode, or AUX mode which is appeared when an external audio source is connected.

**NOTE:** The maximum volume of the output power speaker will decrease when your USB device is being charged.

**NOTE:** The USB socket can provide max 2.4 A 5 V (2 port total) of electrical current.

## Charging the battery cartridge

To charge the battery cartridge with this radio, insert the adaptor plug into the DC IN socket and then plug it to the mains. After that, insert the battery cartridge to the slot.

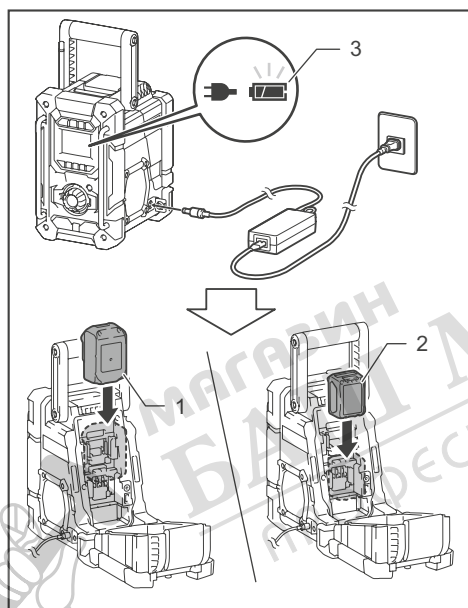

- 1. LXT battery cartridge 2. CXT battery cartridge  
3. Indicator for battery status/capacity

The indicator for battery status/capacity blinks when the battery cartridge is being charged. The charging status is as follows:

Indicator for battery status/capacity	Charging status
(blinking)	Charging (less than 80%)
(blinking)	Charging (80% or more has been charged)
(not blinking)	Charged (100%)

**NOTICE:** You cannot charge LXT and CXT battery cartridges at the same time.

**NOTE:** It will take several seconds until the indicator for battery status/capacity appears after the AC power adaptor is plugged into the mains.

**NOTE:** If the AC power adaptor is disconnected from the radio during battery charging, the radio turns off for a few seconds and then automatically turns on with the battery power supply.

## Hook for the AC power adaptor

The hook on the back of the radio is useful for carrying the AC power adaptor. When carrying, bundle the cords and tie them with AC power adaptor using the band.

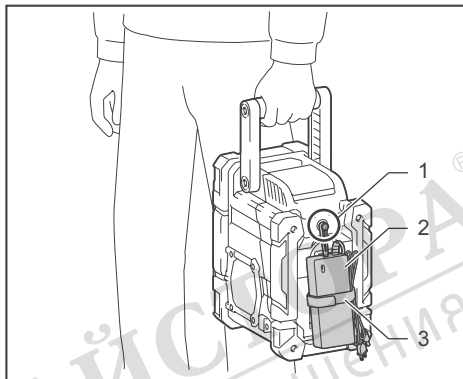

- 1. Hook 2. AC power adaptor 3. Band

**NOTICE:** Do not store AC power adaptor in the battery compartment. The cord may be pinched and damaged when closing the battery cover.

**NOTICE:** Always hold the handle when carrying the radio.

**NOTICE:** Be careful not to drop the AC power adaptor hooked on the back of the radio.

## Bottle cap opener

The bottle cap opener is provided on the back of the radio.

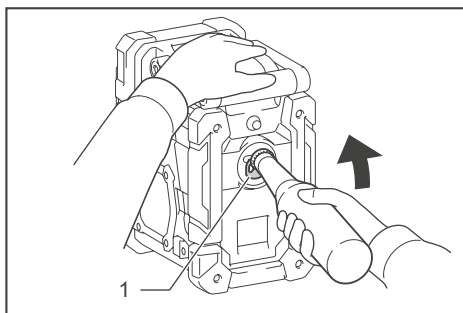

- 1. Bottle cap opener

**NOTICE:** Hold the radio firmly when using the bottle cap opener. Failure to do so may cause the radio tipped over and result in damage or malfunction.



**NOTICE:** Be careful not to spill the beverage onto the radio when opening the cap.

# OPERATION

## Switching on/off the radio



Press the Power button  to switch on the radio.  
Press the Power button  again to switch off the radio.

## Adjusting the volume level

Turn the Tuning control knob  clockwise to increase the volume. Turn the Tuning control knob  counter-clockwise to decrease the volume.

**NOTE:** The volume adjustment is not available during tuning and some settings.

## Scan tuning AM/FM or DAB





1. Press the Power button  to switch on your radio.
2. Press the Source button  to select AM/FM or DAB radio mode.
3. Press and hold the Tuning control knob  to carry out an auto-tune.

Your radio will scan up the AM/FM or DAB band from the currently displayed frequency and will stop scanning automatically when it finds a station of sufficient strength.

**NOTE:** The stations to be found by scan tuning vary depending on the receiving sensitivity at the location where the scan tuning is performed. If you don't have desired station, change the location and perform the procedure above.

**NOTE:** When the end of the waveband is reached your radio will recommence tuning from the opposite end of the waveband.

## Manual tuning – FM/AM or DAB

1. Press the Power button  to switch on your radio.
2. Press the Source button  to select FM/AM or DAB radio mode.
3. Press the Tuning control knob .
4. Rotate the Tuning control knob  to tune to a station.
5. Press the Tuning control knob  to set the tuning.



**NOTE:** Manual tuning is available while "MANUAL TUNING" is displayed on the display. If "MANUAL TUNING" is not displayed, start the manual tuning from the beginning.

**NOTE:** The stations to be found by manual tuning vary depending on the receiving sensitivity at the location where the manual tuning is performed. If you don't have desired station, change the location and perform the procedure above.

**NOTE:** When the end of the waveband is reached your radio will recommence tuning from the opposite end of the waveband.

## Presetting stations in FM/AM or DAB

There are 5 preset stations each for FM/AM or DAB radio. They are used in the same way for each waveband.

1. Press the Power button  to switch on your radio.
2. Press the Source button  to select the desired waveband. Tune to the required radio station.
3. Press and hold the required Preset button (1 to 5)  until the display shows "PRESET X STORED" (X indicates the number of the Preset button that you pressed). The station will be stored using the preset number (P1-P5). Repeat this procedure for the remaining presets as you wish.

**NOTE:** Preset stations which have already been stored may be overwritten by following the above procedure.

## Recalling a preset station in AM/FM or DAB

1. Press the Power button  to switch on your radio.
2. Press the Source button  to select AM, FM or DAB radio mode.
3. Press the desired Preset button  that you stored in the preset memory.

## Display modes – FM

Your radio has a range of display options for FM radio mode.

Station name	Displays the name of the station being listened to, together with the band and frequency.
Program type	Displays the type of station being listened to such as Pop, Classic, News, etc, together with the band and frequency.
Radio text	Displays radio text message such as new items etc, together with the band and frequency.
Time/Date	Displays the time and date according to the date setting of your radio.

## Display modes – DAB







Your radio has a range of display options for DAB radio mode.

Station name	Displays the name of the station being listened to.
Program type	Displays the type of station being listened to such as Pop, Classic, News, etc.
Multiplex name	Displays the name of the DAB multiplex to which the current station belongs.
Time/Date	Displays the time and date.
Frequency and channel	Displays the frequency and channel number for the currently tuned DAB station.
Bit rate/ Audio type	Displays the digital audio bit rate and audio type for the currently tuned DAB station.
Signal strength	Displays the signal strength for the currently tuned DAB station.







## Setting the clock

### Setting the time and date format









**NOTE:** The selected time and date format is also used when setting the alarms.

1. Press and hold the Menu/Info button  to enter the menu setting.
2. Rotate the Tuning control knob  until <TIME> appears on the display and press the Tuning control knob  to enter the setting.
3. Rotate the Tuning control knob  until <SET 12/24 HOUR> appears on the display and press the control knob  to enter the setting.
4. Rotate the Tuning control knob  to select either <12 HOUR> or <24 HOUR> format. Press the Tuning control knob  to confirm your choice.











**NOTE:** If the 12 hour clock format is chosen, the radio will then use the 12 hour clock for the setting.

5. Press and hold the Menu/Info button  to enter the menu setting.
6. Rotate the Tuning control knob  until <TIME> appears on the display and press the Tuning control knob  to enter the setting.
7. Rotate the Tuning control knob  until <DATE FORMAT> appears on the display and press the control knob  to enter the setting.
8. Rotate the Tuning control knob  to select the desired date format (<DD/MM/YYYY> or <MM/DD/YYYY>). Press the Tuning control knob  to confirm your choice.

### Setting the time

1. Press and hold the Menu/Info button  to enter the menu setting.
2. Rotate the Tuning control knob  until <TIME> appears on the display. Press the Tuning control knob  to enter the setting.
3. Press the Tuning control knob  while <SET TIME> appears on the display to enter the setting.
4. The hour setting on the display will begin flashing. Rotate the Tuning control knob  to select the desired hour, and press the Tuning control knob  to confirm the setting. Then rotate the Tuning control knob  to select the desired minute, and press the Tuning control knob  to confirm the setting.







### Setting the date

1. Press and hold the Menu/Info button  to enter the menu setting.
2. Rotate the Tuning control knob  until <TIME> appears on the display. Press the Tuning control knob  to enter the setting.
3. Rotate the Tuning control knob  until <SET DATE> appears on the display. Press the Tuning control knob  to enter the setting.
4. Rotate the Tuning control knob  to select the desired year and press the Tuning control knob  to confirm the setting. Then rotate the Tuning control knob  to select the desired month, and press the Tuning control knob  to confirm the setting. Then rotate the Tuning control knob  to select the desired date and press the Tuning control knob  to confirm the setting.

## Setting the alarm clock

Your radio has two alarms which can each be set to wake you to AM/FM/DAB radio or buzzer alarm. The alarms may be set while the unit is in standby mode or while playing.





### Setting radio alarm time

1. Press and hold the radio alarm button  , the radio alarm symbol and the display hour will flash along with a beep.
2. While the radio alarm symbol  is flashing, rotate Tuning control knob  to select the hour and press Tuning control knob  again to confirm hour setting. Then rotate the Tuning control knob  to select the minute and press Tuning control knob  to confirm minute setting.
3. Rotate the Tuning control knob and the display will show the frequency options for the alarm.

The alarm options are as follows:

ONCE	The alarm will sound once
DAILY	The alarm will sound everyday
WEEKDAYS	The alarm will sound only on weekdays
WEEKENDS	The alarm will sound only at weekends

Press the Tuning control knob  to confirm the setting.







4. Rotate Tuning control knob  to select the band (FM/AM/DAB) and press Tuning control knob  again to confirm the setting.
5. Rotate Tuning control knob  to select <LAST LISTENED> or <PRESET NO.> and press Tuning control knob  again to confirm the setting.
6. Rotate Tuning control knob  to select the desired volume and press Tuning control knob to confirm the volume. Radio alarm setting is now completed.

**NOTE:** If new radio alarm station is not selected, the radio will select the last alarm station.

### Setting HWS (Humane Wake System) buzzer alarm

A beep tone will activate when selecting the HWS buzzer alarm. The alarm beep starts to ring and it becomes quicker as the time elapses. The alarm beep continues to ring for one minute and stops. After one minute silence, the alarm beep resume ringing. The alarm beep repeats this cycle until you press the Power button .

**NOTE:** The buzzer alarm can be set when the radio is turned off.

1. Press and hold the buzzer alarm button  , the symbol and the display hour will flash along with a beep.
2. While the buzzer alarm symbol  is flashing, rotate Tuning control knob  to select the hour and press Tuning control knob  again to confirm hour setting. Then rotate the Tuning control knob  to select the minute and press Tuning control knob  to confirm minute setting.

3. Rotate the Tuning control knob  and the display will show the frequency options for the alarm.

The alarm options are as follows:

ONCE	The alarm will sound once
DAILY	The alarm will sound everyday
WEEKDAYS	The alarm will sound only on weekdays
WEEKENDS	The alarm will sound only at weekends

4. Press the Tuning control knob  to confirm the setting.

**NOTE:** There is no volume adjustment for buzzer alarm.

## When the alarm sounds





To cancel a sounding alarm, press the Power button .

## Disabling/cancelling alarms

To disable an active alarm, press and hold the corresponding alarm button to cancel the alarm.

## Snooze





When the alarm sounds, press any button other than the Power button  to stop the alarm for 5 minutes. "SNOOZE" will appear on the display. To adjust the silence time, follow the procedures below:

1. Press and hold the Menu/Info button  to enter the menu setting.
2. Rotate the Tuning control knob  until "SNOOZE" appears on the display. Press the Tuning control knob  to enter the setting. Rotate the Tuning control knob  to adjust the silence time from 5, 10, 15 and 20 minutes.

**NOTE:** To cancel the snooze timer while the alarm is suspended, press the Power button .

## Sleep timer

Your radio can be set to turn off automatically after a preset time has elapsed. The Sleep Timer setting can be adjusted for 15, 30, 45, 60, 90, or 120 minutes.





1. Press and hold the Power button  to enter the Sleep Timer setting. "SLEEP 60 MINUTES" will be shown on the display.
2. Keep holding the Power button . The sleep timer options will start switching on the display. Release the Power button  when the desired Sleep Timer setting appears on the display. The setting will be saved and the icon for sleep timer () will appear on the display.

**NOTE:** Your radio will switch off automatically after the preset Sleep Timer has elapsed.

**NOTE:** To cancel the sleep timer before the preset time has elapsed, simply press the Power button  to turn the radio off.

## Loudness

You can get compensation on lower and higher frequency for your radio by adjusting the loudness function.

1. Press and hold the Menu/Info button  to enter the menu setting.
2. Rotate the Tuning control knob  until <LOUDNESS> appears on the display. Press the Tuning control knob to enter the setting.
3. Rotate the Tuning control knob  to choose <ON> or <OFF> to turn on or turn off the loudness function, then press the Tuning control knob  to confirm the setting.

**NOTE:** To turn off the loudness function, select <OFF> and press the Tuning control knob  to confirm the setting.

## Listening to Bluetooth® music

You need to pair your Bluetooth® device with your radio before you can auto-link to play/stream Bluetooth® music through your radio. Pairing creates a permanent "bond" so two devices can always recognize each other.

## Pairing your Bluetooth® device

1. Press the Source button  to select Bluetooth® function. "READY BLUETOOTH" will be shown on the display and "READY" will flash.
2. Activate Bluetooth® on your device according to the device's user manual to allow the pairing procedure.
3. Press and release the Pair button . "PAIR BLUETOOTH" will be shown on the display and it will flash. You can start the search of your radio on your Bluetooth® device. Once the name of your radio is appeared on your Bluetooth® device, press the item in your Bluetooth® list.

**NOTE:** With some mobiles (versions earlier than BT.2.1 Bluetooth® device), you may need to input the pass code "0000".

4. Your Bluetooth® device will be linked with the radio. Once connected, "CONNECTED BLUETOOTH" will appear on the display.

You can now play the music in your Bluetooth® device via your radio.

## Playing Bluetooth® device which has already paired

1. Press the Source button  to select Bluetooth® function. "READY BLUETOOTH" will be shown on the display and "READY" will flash.
2. Search and link the radio on your Bluetooth® device. Some device may link with the radio automatically.

You can now play the music in your Bluetooth® device via your radio.

**NOTE:** The radio can pair with 8 Bluetooth® devices at most. When you pair Bluetooth® devices more than this number, pairing history will be overwritten from the oldest pairing history.

**NOTE:** If there are 2 Bluetooth® devices searching for your radio, it will show its availability on both devices.

**NOTE:** If your Bluetooth® device is temporarily disconnected to your radio, then you need to manually reconnect your device again to the radio.

**NOTE:** If the name of your radio is appeared on your Bluetooth® device list but your device cannot connect with it, delete the item name of your radio from your list and pair the device with your radio again following the steps described previously.

**NOTE:** The optimum operation range between the radio and the paired device is approximately 10 meters (30 feet).

**NOTE:** Any obstacle between the radio and the device can reduce the operational range.







## Disconnecting your Bluetooth® device

1. Press and hold the Pair button  for a few seconds to disconnect with your Bluetooth® device. "CONNECTED BLUETOOTH" will turn to be "PAIR BLUETOOTH".
2. Press the Power button .

## Language options

### For DMR301 only





There are four language options available in the radio: English, Italian, French, and German.

1. Press the Source button  to select DAB radio mode.
2. Rotate the Tuning Control knob  until <System> shown on the display. Press the Tuning Control knob  to enter the setting.
3. Rotate the Tuning Control knob  to choose <Language>.
4. Rotate the Tuning Control knob  to choose the language and press the Tuning Control knob  to confirm.

## System reset





### For DMR301 only

If your radio fails to work correctly, or some digits on the display are missing or incomplete, carry out the following procedure.

1. Press the Source button  to select DAB radio mode.
2. Rotate the Tuning Control knob  until <System> shown on the display. Press the Tuning Control knob  to enter the setting.
3. Rotate the Tuning Control knob  to choose <Factory Reset>. Press the Tuning Control knob  to confirm the setting (<Yes>) and a full reset will be performed.

## Software version

### For DMR301 only

1. Press the Source button  to select DAB radio mode.
2. Rotate the Tuning Control knob  until <System> shown on the display. Press the Tuning Control knob  to enter the setting.
3. Rotate the Tuning Control knob  to choose <SW Version> and press the Tuning Control knob  you will view the software version installed in the radio.

## MAINTENANCE

**CAUTION:** Always be sure that the appliance is switched off and the battery cartridge is removed before attempting to perform inspection or maintenance.

**NOTICE:** Never use gasoline, benzine, thinner, alcohol or the like. Discoloration, deformation or cracks may result.

To maintain product SAFETY and RELIABILITY, repairs, any other maintenance or adjustment should be performed by Makita Authorized or Factory Service Centers, always using Makita replacement parts.

## OPTIONAL ACCESSORIES

**CAUTION:** These accessories or attachments are recommended for use with your Makita tool specified in this manual. The use of any other accessories or attachments might present a risk of injury to persons. Only use accessory or attachment for its stated purpose.

If you need any assistance for more details regarding these accessories, ask your local Makita Service Center.

- Makita genuine battery and charger

**NOTE:** Some items in the list may be included in the tool package as standard accessories. They may differ from country to country.



МАГАЗИН  
**БАШ МАЙСТОРА**<sup>®</sup>  
ПРОФЕСИОНАЛНИ РЕШЕНИЯ

Makita Europe N.V. Jan-Baptist Vinkstraat 2,  
3070 Kortenberg, Belgium

Makita Corporation 3-11-8, Sumiyoshi-cho,  
Anjo, Aichi 446-8502 Japan

[www.makita.com](http://www.makita.com)

DMR300-  
ENEU-1911  
EN  
20201222