



Operator's manual

SILENO city | smart SILENO city | SILENO life | smart SILENO life



gardena.com

Contents

1 Introduction	
1.1 Introduction.....	3
1.2 Product overview.....	4
1.3 Symbols on the product.....	5
1.4 Symbols on the display.....	5
1.5 Symbols on the battery.....	6
1.6 General manual instructions.....	6
1.7 Menu structure overview 1.....	7
1.8 Menu structure overview 2.....	8
1.9 Display.....	9
1.10 Keypad	9
2 Safety	
2.1 Safety information.....	10
2.2 Safety definitions.....	11
2.3 Safety instructions for operation.....	11
3 Installation	
3.1 Introduction - Installation.....	14
3.2 Main components for installation.....	14
3.3 General preparations.....	14
3.4 Before the installation of the wires.....	14
3.5 Installation of the product.....	19
3.6 To put the wire into position with stakes.....	21
3.7 To bury the boundary wire or the guide wire.....	21
3.8 To extend the boundary wire or the guide wire...21	
3.9 After the installation of the product.....	22
3.10 To do the product settings.....	22
4 Operation	
4.1 To use the ON/OFF button.....	31
4.2 To start the product.....	31
4.3 Operating modes.....	31
4.4 To stop the product.....	32
4.5 To set the product to OFF.....	32
4.6 To charge the battery.....	32
4.7 Adjust the cutting height.....	32
5 Maintenance	
5.1 Introduction - maintenance.....	34
5.2 Clean the product.....	34
5.3 Replace the blades.....	35
5.4 Firmware update.....	35
5.5 Battery.....	36
5.6 Winter service.....	36
6 Troubleshooting	
6.1 Introduction - troubleshooting.....	38
6.2 Fault messages.....	38
6.3 Information messages.....	43
6.4 Indicator lamp in the charging station.....	44
6.5 Symptoms.....	45
6.6 Find breaks in the loop wire.....	46
7 Transportation, storage and disposal	
7.1 Transportation.....	49
7.2 Storage.....	49
7.3 Disposal.....	49
8 Technical data	
8.1 Technical data.....	50
9 Warranty	
9.1 Warranty terms.....	53
10 EU Declaration of Conformity	
11 UK Declaration of Conformity	

1 Introduction

1.1 Introduction

Serial number:
PIN code:
Product registration key:

The serial number is on the product carton and on the product rating plate. Refer to *Product overview on page 4*.

- Use the serial number to register your product on www.gardena.com.

1.1.1 Support

For support about the GARDENA product, speak to your GARDENA service.

1.1.2 Product description

Note: GARDENA regularly updates the appearance and function of the products. Refer to *Support on page 3*.

The product is a robotic lawn mower. The product has a battery power source and cuts the grass automatically. It continuously alternates between mowing and charging. The movement pattern is random, which means that the lawn is mowed evenly and with less wear. The boundary wire and the guide wire controls the movement of the product within the work area. Sensors in the product senses when it is approaching the boundary wire. The front of the product always passes the boundary wire by a specific distance before the product turns around. When the product hits an obstacle or approaches the boundary wire the product selects a new direction.

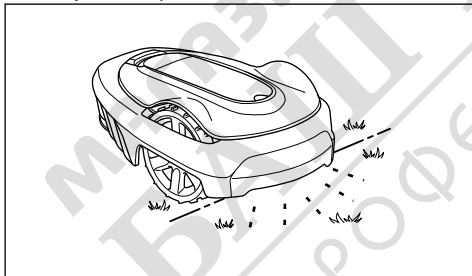

The operator selects the operation settings with the keys on the keypad. The display shows the selected and possible operation settings, and the operation mode of the product.

1.1.2.1 Mowing technique

The product is emission free, easy to use and saves energy. The frequent cutting technique improves the grass quality and decreases the use of fertilizers. Collection of grass is not necessary.

1.1.2.2 Find the charging station

The product operates until the battery state of charge is low, then the product starts to go to the charging station. The guide wire is put from the charging station to a remote part of the work area or through a narrow passage. The guide wire is connected with the boundary wire to make it easier and faster for the product to find the charging station.

1.2 Product overview

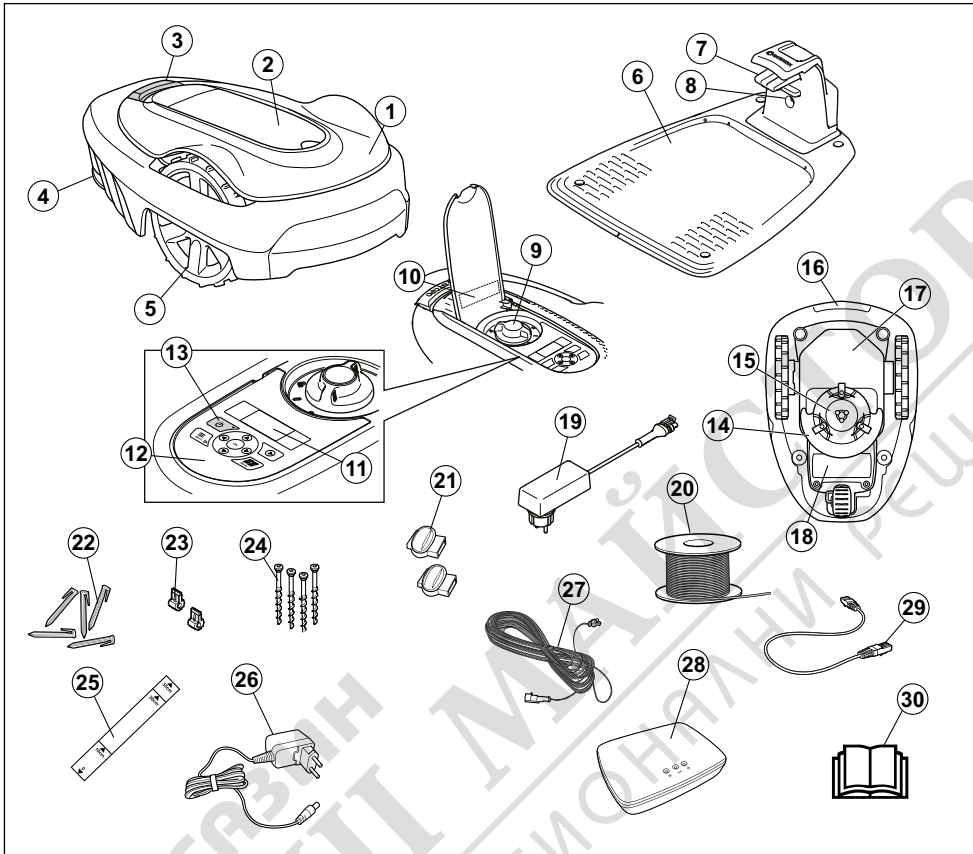

The numbers in the figure represent:

- | | |
|--|---|
| 1. Body | 13. ON/OFF button |
| 2. Hatch to display and keypad | 14. Cutting system |
| 3. Stop button | 15. Blade disc |
| 4. Rear wheel (SILENO city) / Rear wheels (SILENO life) | 16. Handle |
| 5. Front wheels | 17. Chassis box with electronics, battery and motors |
| 6. Charging station | 18. Battery cover |
| 7. Contact plates | 19. Power supply ¹ |
| 8. LED for operation check of the charging station, boundary wire and guide wire | 20. Loop wire for boundary loop and guide wire |
| 9. Cutting height adjustment | 21. Couplers for loop wire |
| 10. Rating plate | 22. Stakes |
| 11. Display | 23. Connector for the loop wire |
| 12. Keypad | 24. Screws for securing the charging station |
| | 25. Measurement gauge for help when installing the boundary wire (the measurement gauge is broken loose from the box) |

¹ The appearance may differ depending on market.

- 26. smart gateway power supply (only for smart model)
- 27. Low-voltage cable
- 28. smart gateway (only for smart model)
- 29. smart gateway LAN-cable (only for smart model)
- 30. Operator's Manual and Quick Guide

1.3 Symbols on the product

These symbols can be found on the product. Study them carefully.



WARNING: Read the user instructions before operating the product.



WARNING: Disable the product before working on or lifting the product.



WARNING: Keep a safe distance from the product when operating. Keep your hands and feet away from the rotating blades.



WARNING: Do not ride on the product. Do not put your hands or feet close to or under the product.

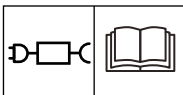

Use a detachable power supply as defined on the rating plate next to the symbol.



This product complies with the applicable EU Directives.



This product complies with the applicable UK Directives.



It is not permitted to dispose this product as normal household waste. Ensure that the product is recycled in accordance with local legal requirements.

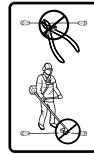

The low-voltage cable must not be shortened, extended or spliced.

Do not use a trimmer nearby the low-voltage cable. Be careful when trimming edges where the cables are placed.

1.4 Symbols on the display



The schedule menu is used to set when the product cuts the lawn.



The SensorControl function automatically adapts the cutting intervals to the grass growth.



The settings menu is used to set the general product settings.



Only for smart SILENO city and smart SILENO life.



The GARDENA smart system enables wireless interaction between your smart product and the GARDENA smart system.



The product will not cut the grass due to the schedule function.



The product overrides the schedule function.



The battery indicator shows the battery state of charge. When the product charges the symbol flashes.



The product is in the charging station but do not charge the battery.



The product is set in ECO-mode.

1.5 Symbols on the battery



Read the user instructions.



Do not discard the battery into fire and do not expose the battery to a heat source.



Do not immerse the battery into water.

1.6 General manual instructions

The following system is used in the Operator's Manual to make it easier to use:

- Text written in *italics* is a text that is shown in the display or is a reference to another section in the Operator's Manual.
- Text written in **bold** is one of the buttons on the product.

МАГАЗИН
БАШ МАЙСТОРА[®]
ПРОФЕСІОНАЛНИ РЕШЕНИЯ

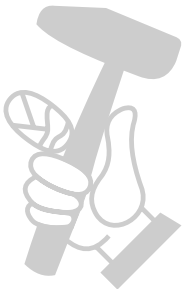

1.7 Menu structure overview 1

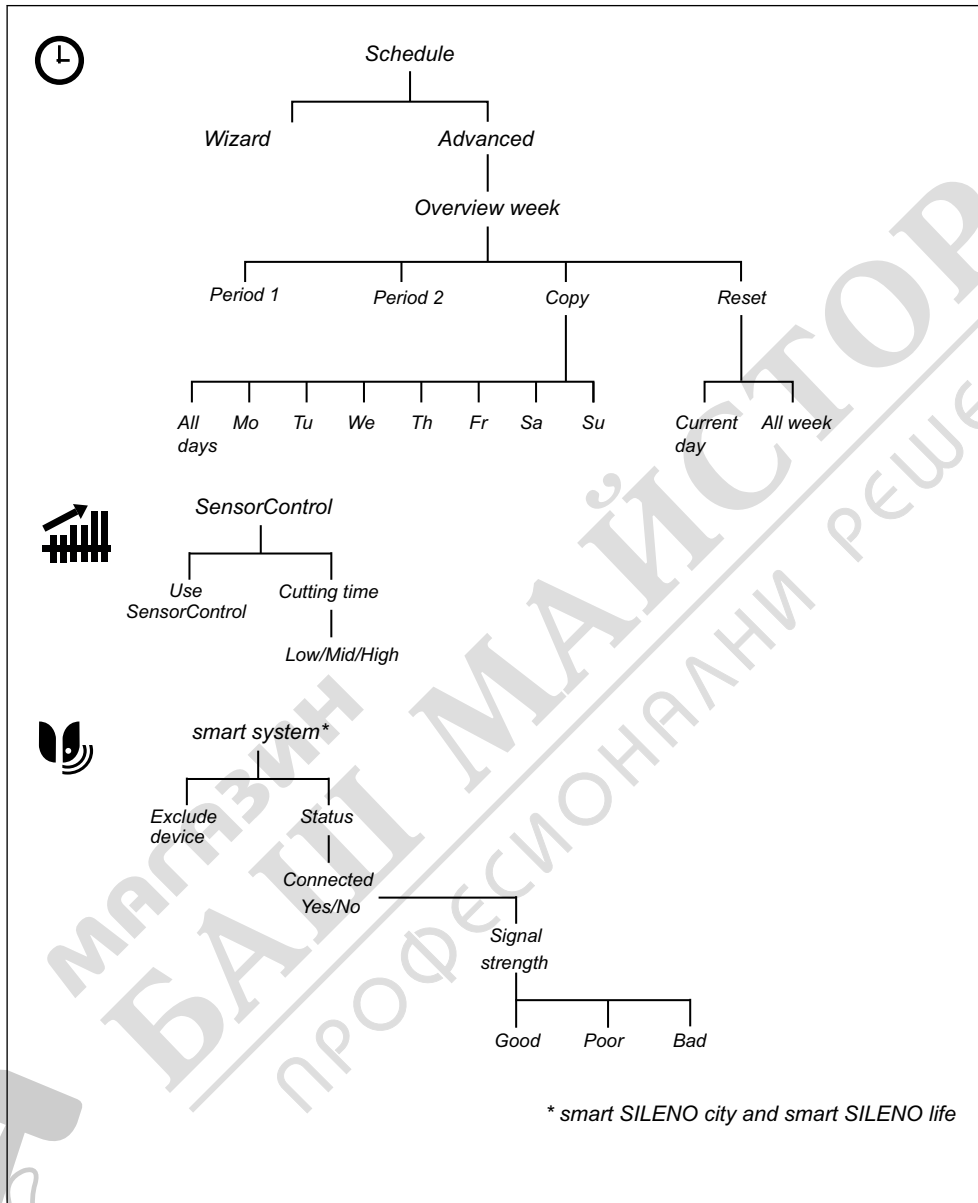

1.8 Menu structure overview 2

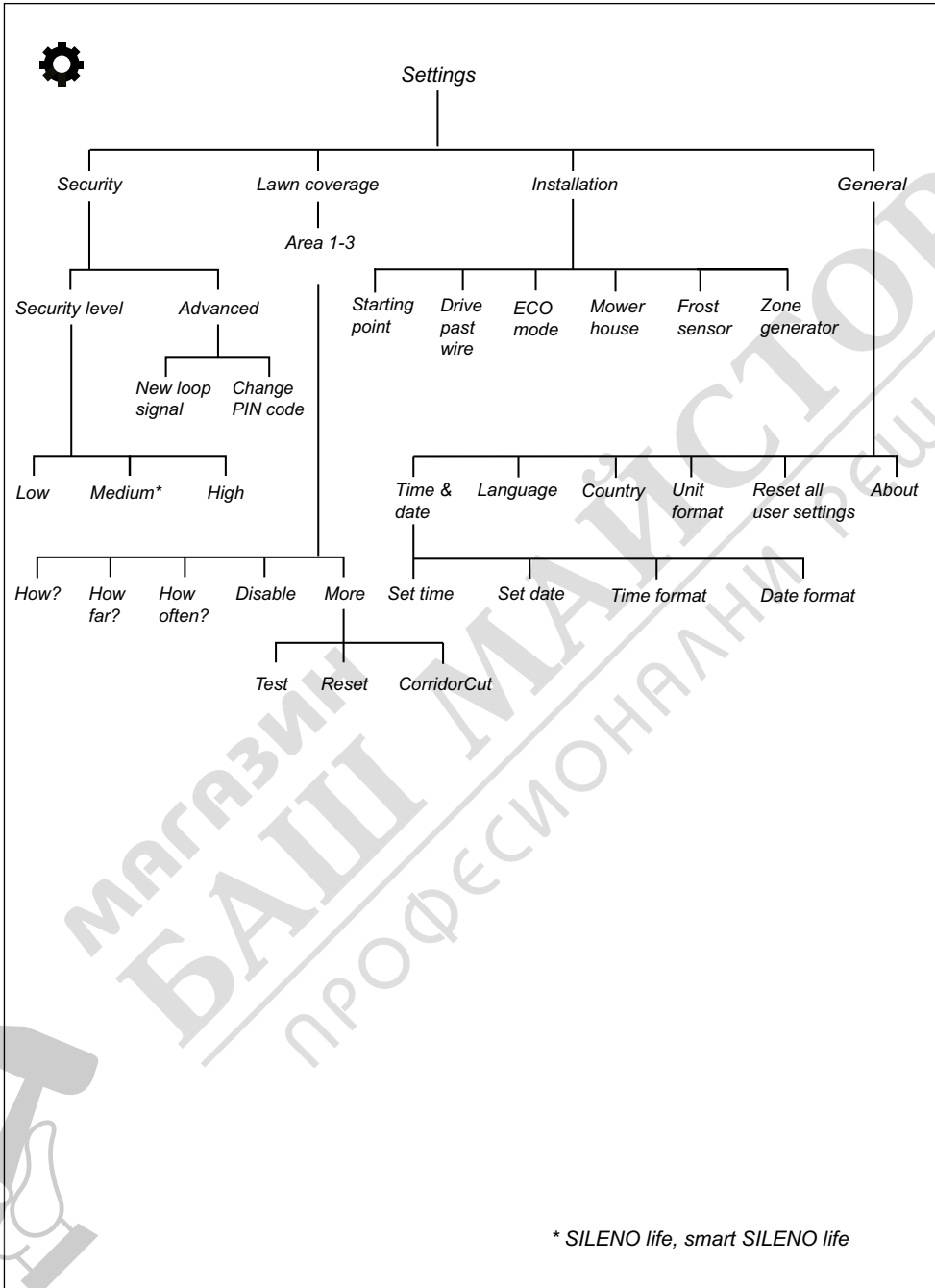

1.9 Display

The display on the product shows information and settings of the product.

To access the display, push the **STOP** button and open the hatch.

1.10 Keypad

The keypad on the product lets the operator navigate in the menu. To access the keypad, push the **STOP** button and open the hatch.

- Use the **ON/OFF** button (A) to switch on and switch off the product. The indicator lamp on the keypad is an important status indicator. Refer to *To use the ON/OFF button on page 31*.
- Use the **Start** button (B) to start the operation of the product.
- Use the **Menu** button (C) to go to the main menu.

Note: The **Menu** button is also used as a **Back** button to move up in the menu lists.

- Use the **Mode** button (D) to select operating mode.
- Use the **OK** button (E) to confirm the settings you select in the menus.
- Use **arrow** buttons (F) to navigate in the menu. Use the up/down **arrow** buttons to enter PIN code, time and date.

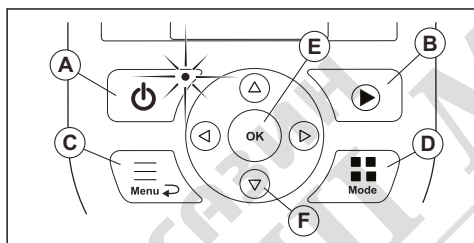

2 Safety

2.1 Safety information

2.1.1 IMPORTANT. READ CAREFULLY BEFORE USE. KEEP FOR FUTURE REFERENCE

The operator is responsible for accidents or hazards occurring to other people or property.

This appliance is not intended for use by persons (including children) with reduced physical, sensory or mental capabilities (that could affect a safe handling of the product), or lack of experience and knowledge, unless they have been given supervision or instruction concerning use of the appliance by a person responsible for their safety.

This appliance can be used by children aged from 8 years and above and persons with reduced physical, sensory or mental capabilities or lack of experience and knowledge if they have been given supervision or instruction concerning use of the appliance in a safe way and understand the hazards involved. Local regulations may restrict the age of the operator. Cleaning and maintenance shall not be made by children without supervision.

Never connect the power supply to an outlet if the plug or cord is damaged. Worn or damaged cord increase the risk of electric shock.

Only charge the battery in the included charging station. Incorrect use may result in electric shock, overheating or leaking of corrosive liquid from the battery. In the event of leakage of electrolyte, flush with water/neutralizing agent. Seek medical help if it comes in contact with the eyes.

Use only original batteries recommended by the manufacturer. Product safety cannot be guaranteed with other than original batteries. Do not use non-rechargeable batteries.

The appliance must be disconnected from the supply mains when removing the battery.



WARNING: The product can be dangerous if used incorrectly.



CAUTION: Used if there is a risk of damage to the product, other materials or the adjacent area if the instructions in the manual are not obeyed.



WARNING: Do not use the product when persons, especially children, or animals are in the work area.



WARNING: Keep your hands and feet away from the rotating blades. Never put your hands or feet close to or under the product when it is switched on.



WARNING: In the event of an injury or accident seek medical help.

2.2 Safety definitions

Warnings, cautions and notes are used to point out specially important parts of the manual.



WARNING: Used if there is a risk of injury or death for the operator or bystanders if the instructions in the manual are not obeyed.

Note: Used to give more information that is necessary in a given situation.

2.3 Safety instructions for operation

2.3.1 Use

- The product may only be used with the equipment recommended by the manufacturer. All other types of use are incorrect. The manufacturer's instructions with regard to operation/maintenance must be followed precisely.
- Warning signs shall be placed around the work area of the product if it is used in public areas. The signs shall have the following text: **Warning! Automatic lawnmower! Keep away from the machine! Supervise children!**

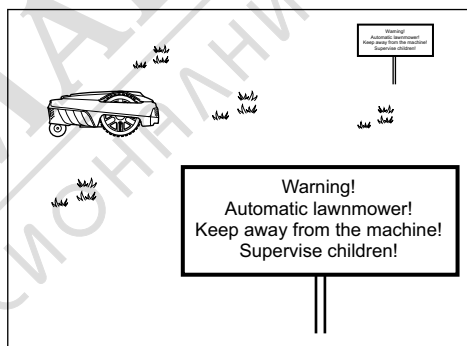

- Use the park mode, refer to *Park* on page 32 or switch off the product when persons, especially children, or animals are in the work area. It is recommended to program the product for use during hours when the area is free from activity. Refer to *To set the schedule* on page 23. Consider that certain animals, e.g. hedgehogs, are active at night. They can potentially be harmed by the product.
- Do not install the charging station, including any accessory, at a location that is below, or within 60 cm / 24 in. from, any combustible material. Do not install the power supply unit in easily flammable surroundings. In case of malfunction, heating of the charging station and the power supply may occur and create a potential risk of fire.

- The product may only be operated, maintained and repaired by persons that are fully conversant with its special characteristics and safety regulations. Please read the Operator's Manual carefully and make sure you understand the instructions before using the product.
- It is not permitted to modify the original design of the product. All modifications are made at your own risk.
- Check that there are no foreign objects such as stones, branches, tools or toys on the lawn. If the blades hit foreign objects, the blades can be damaged. Always switch off the product with the **ON/OFF** button before clearing a blockage. Inspect the product for damage before starting the product again.

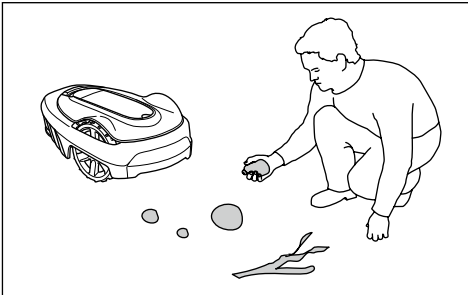

- If the product starts to vibrate abnormally. Always switch off the product with the **ON/OFF** button and inspect for damage before starting the product again.
- Start the product according to the instructions. When the product is switched on, make sure to keep your hands and feet away from the rotating blades. Never put your hands and feet under the product.
- Never touch moving hazardous parts, such as the blade disc, before it has come to a complete stop.
- Never lift up the product or carry it around when it is switched on.
- Do not let persons who do not know how the product works and behaves use it.
- The product must never be allowed to collide with persons or other living creatures. If a person or other living creature comes in the product's way, it shall be stopped immediately. Refer to *To stop the product on page 32*.
- Do not put anything on top of the product or its charging station.
- Do not allow the product to be used with a defective guard, blade disc or body. Neither should it be used with defective blades, screws, nuts or cables. Never connect a damaged cable, or touch a damaged cable before it is disconnected from the supply.

- Do not use the product if the **ON/OFF** button and **STOP** button does not work.
- Always switch off the product using the **ON/OFF** button when the product is not in use. The product can only start when the product has been switched on with the **ON/OFF** button and the correct PIN code has been entered.
- GARDENA does not guarantee full compatibility between the product and other types of wireless systems such as remote controls, radio transmitters, hearing loops, underground electric animal fencing or similar.
- Metal objects in the ground (for example reinforced concrete or anti-mole nets) can result in a stoppage. The metal objects can cause interference with the loop signal which then can lead to a stoppage.
- Operation and storage temperature range is 0-50 °C / 32-122 °F. Temperature range for charging is 0-45 °C / 32-113 °F. Too high temperatures might cause damage to the product.

2.3.2 Battery safety



WARNING: Lithium-ion batteries can explode or cause fire if disassembled, short-circuited, exposed to water, fire, or high temperatures. Handle carefully, do not dismantle, open the battery or use any type of electrical/mechanical abuse. Avoid storage in direct sunlight.

For more information about the battery, refer to *Battery on page 36*

2.3.3 How to lift and move the product



WARNING: The product must be switched off before lifting it. The product is disabled when the indicator lamp on the keypad is not lit.



CAUTION: Do not lift the product when it is parked in the charging station. It can damage the charging station and/or the product. Push **STOP** and pull the product out of the charging station before lifting it.

To safely move from or within the work area:

1. Push the **STOP** button to stop the product.

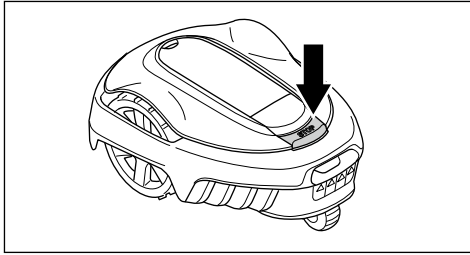

2. Push the **ON/OFF** button for 3 seconds and make sure the product is switched off. Check that the indicator lamp on the keypad is not lit. This means that the product is disabled. Refer to *Indicator lamp in the charging station on page 44*.

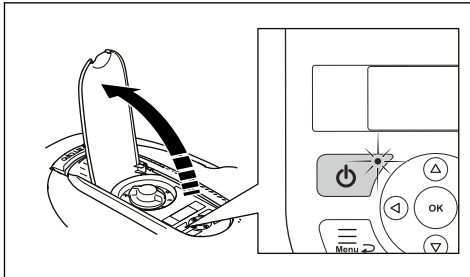

3. Carry the product by the handle with the blade disc away from the body.

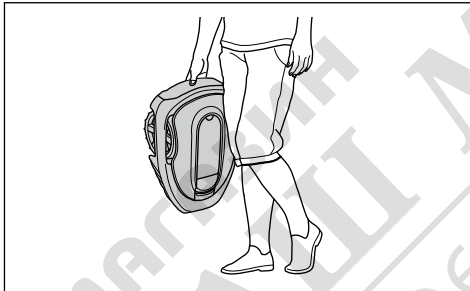

2.3.4 Maintenance



WARNING: Set the product to OFF before you do maintenance on the product. The product is disabled when the LED indicator on the keypad of the product goes out.



WARNING: Disconnect the power supply to the charging station before you clean or do maintenance of the charging station or the loop wire.

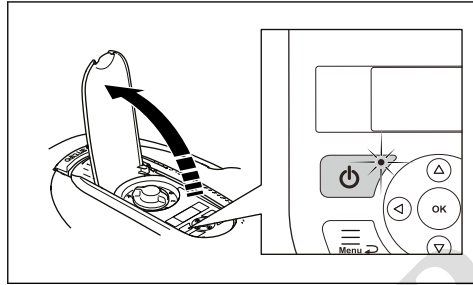

CAUTION: Do not use a high-pressure washer to clean the product. Do not use solvents to clean the product.

Examine the product each week and replace damaged or worn parts. Refer to *Maintenance on page 34*.

2.3.5 In the event of a thunderstorm

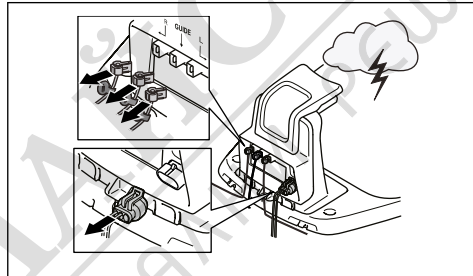

To reduce the risk of damage to electrical components in the product and the charging station, we recommend that all connections to the charging station are disconnected (power supply, boundary wire and guide wire) if there is a risk of a thunderstorm.

1. Mark the wires to simplify reconnecting. The charging station's connections are marked R, L and GUIDE.
2. Disconnect all connected wires and the power supply.
3. Connect all the wires and the power supply if there is no longer a risk of thunder. It is important that each wire is connected to the right place.

3 Installation

3.1 Introduction - Installation

Refer to www.gardena.com for more information about installation and instruction videos.

We recommend you to update the firmware before you install the product to make sure that the product has the latest firmware. Refer to *Firmware update on page 35*.



WARNING: Read and understand the safety chapter before you install the product.



CAUTION: Use original spare parts and installation material.

3.2 Main components for installation

The installation involves the following components:

- A robotic lawn mower that mows the lawn automatically.
- A charging station, which has 3 functions:
 - To send control signals along the boundary wire.
 - To send control signals along the guide wire so that the product can follow the guide wire to specific remote areas in the garden and can find its way back to the charging station.
 - To charge the product.
- A power supply, which is connected to the charging station and a 100-240V power outlet.
- Loop wire, which is laid around the work area and around objects and plants that the product must not run into. The loop wire is used both as boundary wire and guide wire.

3.3 General preparations



CAUTION: Holes with water in the lawn can cause damage to the product.

Note: Read through the Installation chapter before beginning the installation. How the installation is done affects how the product performs. It is therefore important to plan the installation carefully.

- Make a blueprint of the work area and include all obstacles. This makes it easier to see the ideal positions for the charging station, the boundary wire and the guide wire.

- Make a mark on the blueprint where to put the charging station, the boundary wire and the guide wire.
- Make a mark on the blueprint where the guide wire connects to the boundary wire. Refer to *To install the guide wire on page 20*.
- Fill in holes in the lawn.
- Cut the grass before you install the product. Make sure that the grass is maximum 4 cm / 1.6 in.

Note: The first weeks after installation the perceived sound level when cutting the grass may be higher than expected. When the product has cut the grass for some time, the perceived sound level is much lower.

3.4 Before the installation of the wires

You can select to attach the wires with stakes or bury them. You can use the 2 procedures for the same work area.



CAUTION: If you use a dethatcher in the work area, bury the boundary wire and the guide wire to prevent them from damage.

3.4.1 To examine where to put the charging station

- Keep a minimum 2 m / 6.6 ft. of free space in front of the charging station. Refer to *To examine where to put the guide wire on page 18*.
- Keep a minimum of 30 cm / 12 in. of free space to the right and left of the center of the charging station.

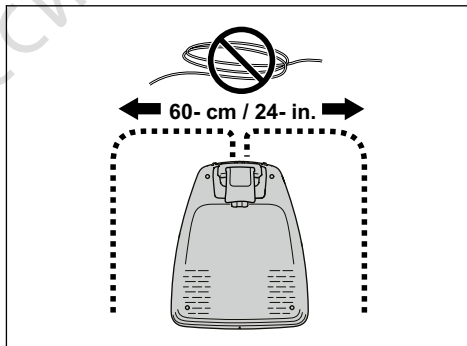

- Put the charging station near a power outlet.
- Put the charging station on a level surface.
- The baseplate of the charging station must not be bent.

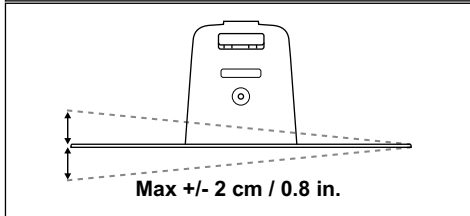
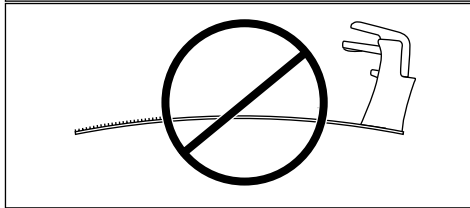
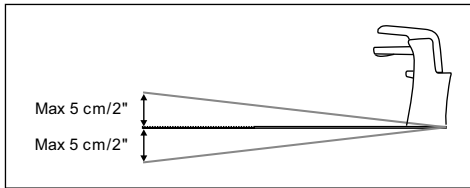

- If the work area has two parts separated with a steep slope, we recommend to put the charging station in the lower section.
- Put the charging station in an area with protection from the sun.
- If the charging station is installed on an island, make sure to connect the guide wire to the island. Refer to *To make an island on page 17*.

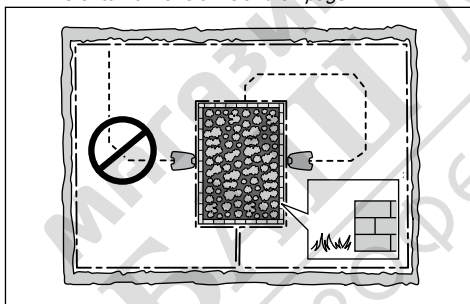

3.4.2 To examine where to put the power supply



WARNING: Do not cut or extend the low-voltage cable. There is a risk of electrical shock.



CAUTION: Make sure that the blades on the product do not cut the low-voltage cable.



CAUTION: Do not put the low-voltage cable in a coil or below the charging station plate. The coil causes interference with the signal from the charging station.



- Put the power supply in an area with a roof and protection from the sun and rain.
- Put the power supply in an area with good airflow.
- Use a residual-current device (RCD) with a tripping current of maximum 30 mA when you connect the power supply to the power outlet.

Low-voltage cables of different lengths are available as accessories.

3.4.3 To examine where to put the boundary wire



CAUTION: There must be a barrier of minimum 15 cm / 6 in. in height between the boundary wire and water bodies, slopes, precipices or public roads. This will prevent damage to the product.



CAUTION: Do not let the product operate on gravel.



CAUTION: Do not make sharp bends when you install the boundary wire.



CAUTION: For careful operation without noise, isolate all obstacles such as trees, roots and stones.

The boundary wire should be put as a loop around the work area. Sensors in the product senses when the product approaches the boundary wire, and the product selects another direction. All parts of the work area must be maximum 15 m / 50 ft. from the boundary wire.

To make the connection easier between the guide wire and the boundary wire, it is recommended to make an eyelet where the guide wire will be connected. Make the

eyelet with approximately 20 cm / 8 in. of the boundary wire.

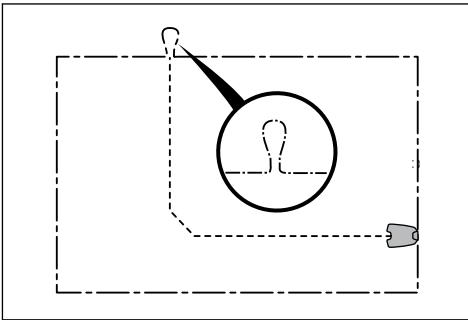

Note: Make a blueprint of the work area before you install the boundary wire and guide wire.

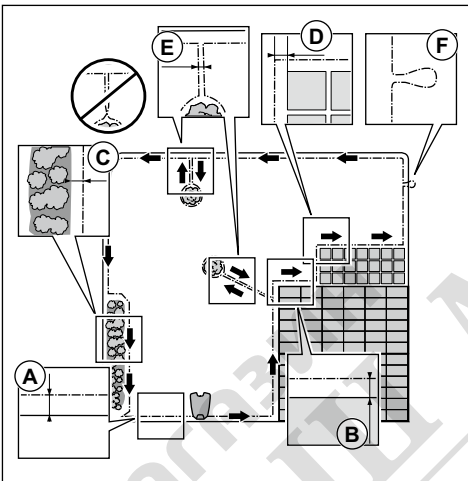

- Put the boundary wire around all of the work area (A). Adapt the distance between the boundary wire and obstacles.
- Put the boundary wire 35 cm / 14 in. (B) from an obstacle that is more than 5 cm / 2 in. high.

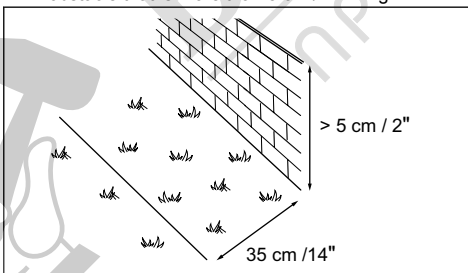

- Put the boundary wire 30 cm / 12 in. (C) from an obstacle that is 1-5 cm / 0.4-2 in. high.

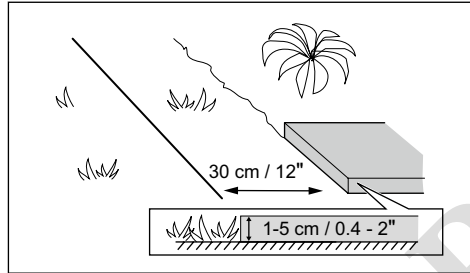

- Put the boundary wire 10 cm / 4 in. (D) from an obstacle that is less than 1 cm / 0.4 in. high.

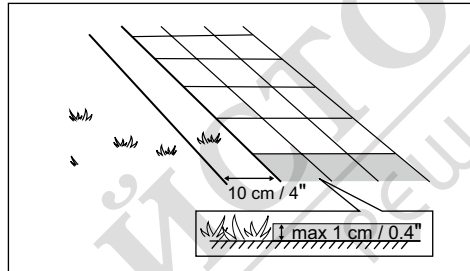

- If you have a paving stone path that is in level with the lawn, put the boundary wire below the paving stone.

Note: If the paving stone is minimum 30 cm / 12 in. wide, use the factory setting for the *Drive Past Wire* function to cut all the grass adjacent to the paving stone. Refer to *To set the Drive Past Wire function on page 27.*

- If you make an island, put the boundary wire that runs to and from the island near together (E). Put the wires in the same stake. Refer to *To make an island on page 17.*
- Make an eyelet (F) where the guide wire is to be connected to the boundary wire.

3.4.3.1 To put the boundary wire in a slope

The product can operate in 35% slopes. Slopes that are too steep must be isolated with the boundary wire. The gradient (%) is calculated as height per m. Example: 10 cm / 100 cm = 10%.

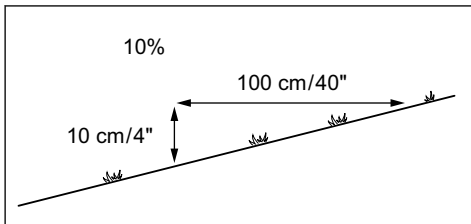

- For slopes steeper than 35% inside the work area, isolate the slope with boundary wire.
- For slopes steeper than 10% along the outer edge of the lawn, put the boundary wire 20 cm / 8 in. (A) from the edge.

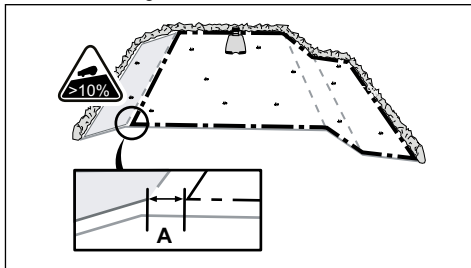

- For slopes adjacent to a public road, put a barrier of minimum 15 cm / 6 in. along the outer edge of the slope. You can use a wall or a fence as a barrier.

3.4.3.2 Passages

A passage is a section that has boundary wire on each side and that connects 2 parts of the work area. The distance between the boundary wire on each side in the passage must be a minimum of 60 cm / 24 in.

Note: If a passage is less than 2 m / 6.5 ft. wide, install a guide wire through the passage.

The recommended minimum distance between the guide wire and the boundary wire is 30 cm / 12 in. The product always runs to the left of the guide wire as seen facing the charging station. It is recommended to have as much free area as possible to the left of the guide wire (A).

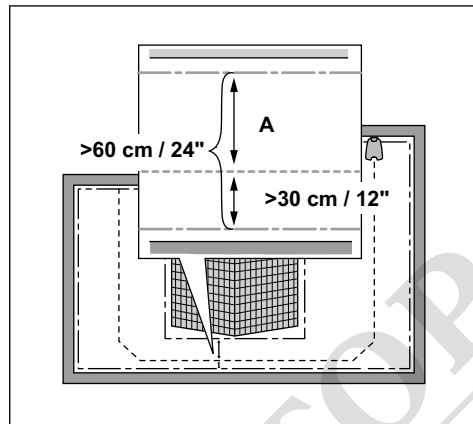

3.4.3.3 To make an island



CAUTION: Do not put a section of boundary wire across the other. The sections of boundary wire must be parallel.



CAUTION: Do not put the guide wire across the boundary wire.



CAUTION: Isolate or remove obstacles that are less than 15 cm / 5.9 in. in height. Isolate or remove obstacles that slope slightly, for example, stones, trees or roots. This will prevent damage to the blades of the product.

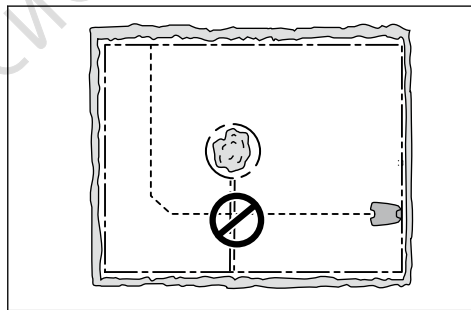

Note: You can also use the ZoneProtect accessory to make a temporary stay-out zone. ZoneProtect is not available in all countries.

To make an island, isolate areas in the work area with the boundary wire. We recommend to isolate all stable objects in the work area.

Some obstacles are resistant to a collision, for example, trees or bushes that are more than 15 cm / 5.9 in. in height. The product will collide with the obstacle and then select a new direction.

- Put the boundary wire to and around the obstacle to make an island.
- Put the 2 sections of boundary wire to and from the island close together. This will make the product run across the wire.
- Put the 2 sections of boundary wire in the same stake.

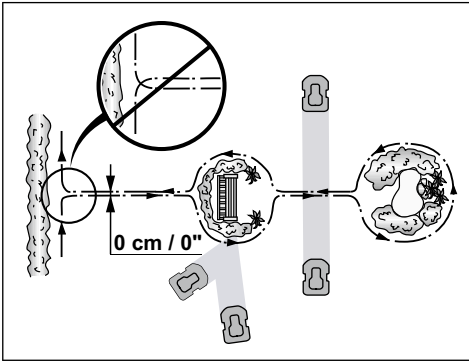

3.4.3.4 To make a secondary area

Make a secondary area (B) if the work area has 2 areas that are not connected with a passage. The work area with the charging station is the main area (A).

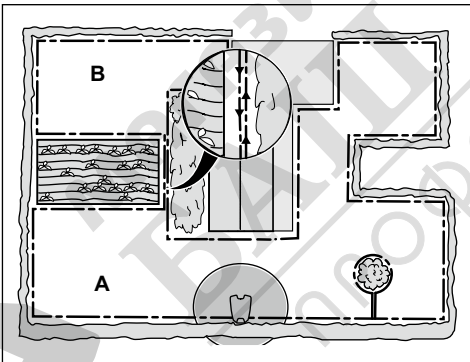

Note: The product must be manually moved between the main area and the secondary area.

- Put the boundary wire around the secondary area (B) to make an island. Refer to *To make an island on page 17*.

Note: The boundary wire must be put as 1 loop around all of the work area (A + B).

Note: When the product cuts grass in the secondary area, the *Secondary area* mode must be selected. Refer to *Secondary area on page 31*.

3.4.4 To examine where to put the guide wire

Put the guide wire from the charging station through the work area and connect it to the boundary wire. The installation of the guide wire is important for a successful guide calibration, refer to *Guide calibration on page 22*.

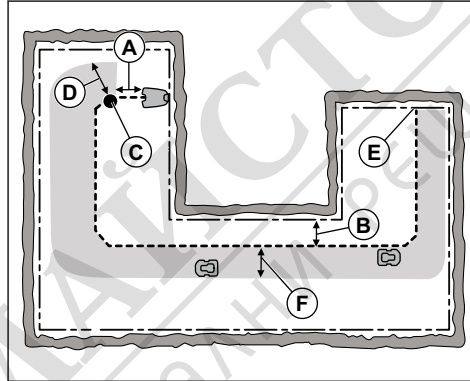

- Put the guide wire in a line at a minimum of 1 m / 3.3 ft. in front of the charging station (A).
- Put the guide wire minimum 30 cm / 1 ft. from the boundary wire (B).
- Starting point (C). Refer to *Starting point on page 27*.
- Minimum distance 60 cm / 2 ft. perpendicular to the guide wire (D). If less distance, the calibration process is interrupted. For the widest possible guide corridor, have a minimum distance of 1.35 m / 4.5 ft. Refer to *Guide calibration on page 22*.
- Where the guide wire is connected to the boundary wire (E).
- Guide corridor (F). The product always runs to the left of the guide wire as seen facing the charging station. Make sure that the guide wire has as much free area as possible to the left of the guide wire.

Note: The product always runs in the guide corridor but changes the distance to the guide wire.

3.4.5 Work area examples

- If the charging station is put in a small area (A), make sure that the distance to the boundary wire is at a minimum 2 m / 6.6 ft. in front of the charging station.
- If the work area has a passage (B) with no guide wire installed, the minimum distance between the boundary wires is 2 m / 6.5 ft. With a guide wire installed through the passage, the minimum distance between the boundary wires is 60 cm / 24 in. Use the *CorridorCut* function to cut this passage. Refer to *Lawn Coverage and CorridorCut* on page 25.
- If the work area has areas which are connected by a narrow passage (B), you can set the product to first follow and then leave the guide wire after a certain distance (C). The settings can be changed in *Lawn Coverage and CorridorCut* on page 25.
- If the work area includes a secondary area (D), refer to *Secondary area* on page 31. Put the product in the secondary area and select *Secondary area mode*.

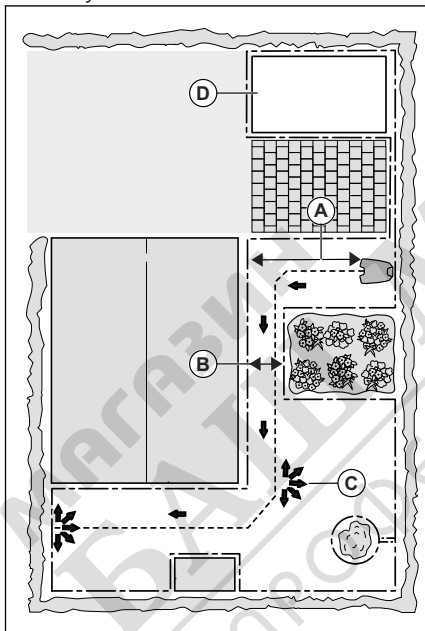

3.5 Installation of the product

3.5.1 Installation tools

- Hammer/plastic mallet: To simplify putting the stakes into the ground.
- Edge cutter/straight spade: To bury the boundary wire.

- Combination pliers: For cutting the boundary wire and pressing the connectors together.
- Adjustable plier: For pressing the couplers together.

3.5.2 To install the charging station



WARNING: Obey national regulations about electrical safety.



WARNING: The product is only to be used with the power supply unit supplied by GARDENA.



WARNING: Do not put the power supply at a height where there is a risk it can be put in water. Do not put the power supply on the ground.



WARNING: Do not encapsulate the power supply. Condensed water can harm the power supply and increase the risk of electrical shock.



WARNING: Risk of Electric Shock. Install only to a residual-current device (RCD) with a tripping current of maximum 30 mA when connecting the power supply to the power outlet. Applicable to USA/Canada. If power supply is installed outdoors: Risk of Electric Shock. Install only to a covered Class A GFCI receptacle (RCD) that has an enclosure that is weatherproof with the attachment plug cap inserted or removed.



CAUTION: Do not make new holes in the charging station plate.



CAUTION: Do not put your feet on the baseplate of the charging station.



WARNING: The power supply cable and extension cable must be outside the work area to avoid damage to the cables.

When connecting the power supply, only use a power outlet that is connected to a residual-current device (RCD).

1. Read and understand the instructions about where to put the charging station. Refer to *To examine where to put the charging station on page 14*.
2. Put the charging station in the selected area.

Note: Do not attach the charging station with the screws to the ground until the guide wire is installed. Refer to *To install the guide wire on page 20*.

3. Connect the low-voltage cable to the charging station.
4. Put the power supply at a minimum height of 30 cm / 12 in.

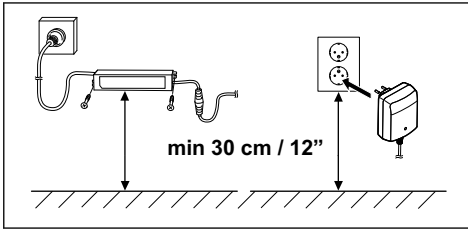

5. Connect the power supply cable to a 100-240V power outlet.

Note: When the charging station is connected, it is possible to charge the product. Put the product in the charging station while the boundary and guide wires are being laid. Switch on the product to start charging the product. Refer to *To use the ON/OFF button on page 31*. Do not continue with any product settings before the installation is complete.

6. Put the low-voltage cable in the ground with stakes or bury the cable. Refer to *To put the wire into position with stakes on page 21* or *To bury the boundary wire or the guide wire on page 21*.
7. Connect the wires to the charging station after the installation of boundary wire and guide wire is complete. Refer to *To install the boundary wire on page 20* and *To install the guide wire on page 20*.
8. Attach the charging station to the ground with the supplied screws after the guide wire is installed. Refer to *To install the guide wire on page 20*.

3.5.3 To install the boundary wire



CAUTION: Do not put remaining wire in a coil. The coil causes interference with the product.

1. Put the boundary wire around all of the work area. Start and complete the installation behind the charging station.

2. Open the connector and put the boundary wire in the connector.

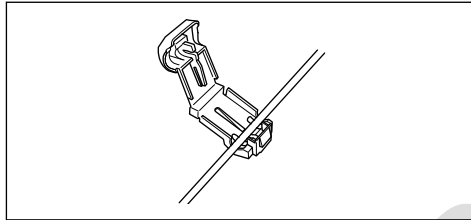

3. Close the connector with a pair of pliers.

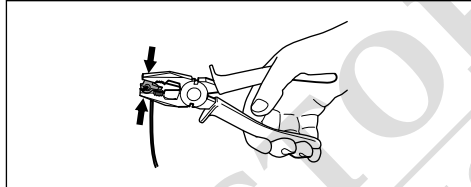

4. Cut the boundary wire 1-2 cm / 0.4-0.8 in. above each connector.
5. Push the right connector onto the metal pin on the charging station with the mark "R".
6. Push the left connector onto the metal pin on the charging station with the mark "L".

3.5.4 To install the guide wire



CAUTION: Twinned cables, or a screw terminal block that is insulated with insulation tape are not satisfactory splices. Soil moisture will cause the wire to oxidize and after a time result in a broken circuit.

1. Open the connector and put the wire in the connector.
2. Close the connector with a pair of pliers.
3. Cut the guide wire 1-2 cm / 0.4-0.8 in. above each connector.
4. Push the guide wire through the slot in the charging station plate.
5. Push the connector onto the metal pin on the charging station with the mark "G".
6. Disconnect the charging station from the power outlet.
7. Put the end of the guide wire at the eyelet on the boundary wire.
8. Cut the boundary wire with a pair of wire cutters.
9. Connect the guide wire to the boundary wire with a coupler.

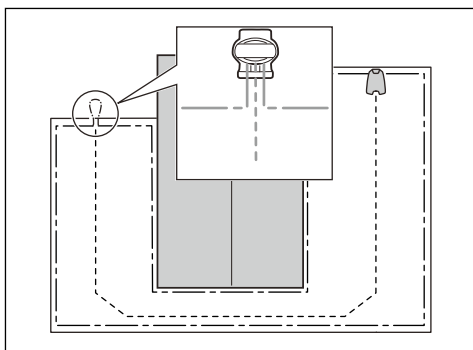

- a) Put the 2 ends of the boundary wire and the end of the guide wire into the coupler.

Note: Make sure that you can see the ends of the wires through the transparent area of the coupler.

- b) Push down the cover on the coupler with adjustable pliers to attach the wires in the coupler.

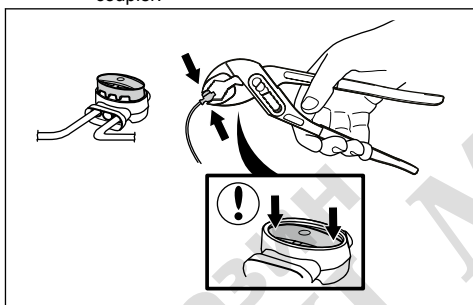

10. Attach the guide wire to the ground with stakes or bury the guide wire in the ground. Refer to *To put the wire into position with stakes on page 21* or *To bury the boundary wire or the guide wire on page 21*.
11. Connect the charging station to the power outlet.

3.6 To put the wire into position with stakes



CAUTION: Make sure that the stakes hold the boundary wire and the guide wire against the ground.



CAUTION: Cutting the grass too low right after installation can damage the wire insulation. Damage to the insulation may not

cause disruptions until several weeks or months later.

1. Put the boundary wire and the guide wire on the ground.
2. Put the stakes at a maximum of 100 cm / 40 in. distance from each other.
3. Attach the stakes to the ground with a hammer or a plastic mallet.

Note: The wire is overgrown with grass and not visible after a few weeks.

3.7 To bury the boundary wire or the guide wire

- Cut a groove in the ground with an edge cutter or a straight shovel.
- Put the boundary wire or the guide wire 1-20 cm / 0.4-8 in. into the ground.

3.8 To extend the boundary wire or the guide wire

Note: Extend the boundary wire or the guide wire if it is too short for the work area. Use original spare parts, for example couplers.

1. Disconnect the charging station from the power outlet.
2. Cut the boundary wire or the guide wire with a pair of wire cutters where it is necessary to install the extension.
3. Add wire where it is necessary to install the extension.
4. Put the boundary wire or the guide wire into position.
5. Put the wire ends into a coupler.

Note: Make sure that you can see the ends of the boundary wire or the guide wire through the transparent area of the coupler.

6. Push down the cover on the coupler with adjustable pliers to attach the wires in the coupler.

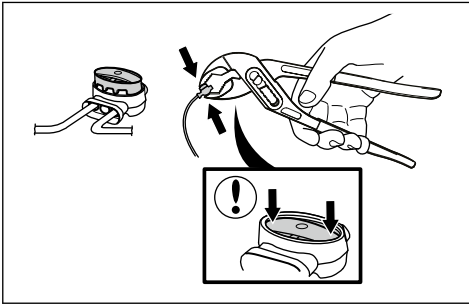

- Put the boundary wire or the guide wire into position with stakes.
- Connect the charging station to the power outlet.

3.9 After the installation of the product

3.9.1 To do a visual check of the charging station

- Make sure that the indicator LED lamp on the charging station has a green light.

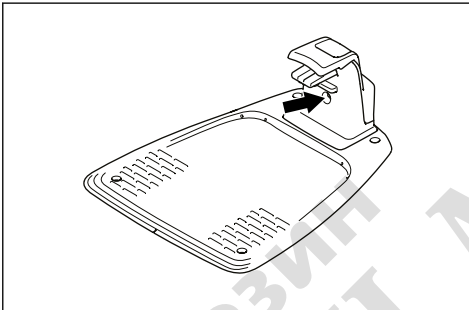

- If the indicator LED lamp does not have a green light, do a check of the installation. Refer to *Indicator lamp in the charging station on page 44* and *To install the charging station on page 19*.

3.9.2 To do the basic settings

Before the product starts to operate for the first time, you must do the basic settings.

- Put the product in the charging station.
- Push the **ON/OFF** button for 3 seconds.

Note: If the battery is very low, the product needs to charge before you can switch on the product.

- Push the **arrow** buttons and the **OK** button. Select language, country, date, time and set a PIN code.

Note: It is not possible to use 0000 as PIN code.

- Push the **Start** button and close the hatch to initiate the guide calibration.

Note: If the battery is too low, the product needs to charge the batteries fully before the guide calibration starts. Refer to *Guide calibration on page 22*.

3.9.3 Guide calibration

The calibration process is automatic and sets as wide guide corridor as possible to decrease tracks on the lawn.

Note: The product always moves in the guide corridor but it changes the distance to the guide wire.

The guide calibration starts when the product is at the starting point. The product moves away from the guide wire perpendicularly at the left side for a maximum distance of 1.35 m / 4.4 ft. or until it hits the boundary wire or an obstacle. The left side means your left when you look straight forward at the charging station. This distance is set as the maximum corridor width and the guide calibration is completed. The product moves along the guide wire to do a test that it can follow the guide wire. The product follows the guide wire to the point where the guide wire is connected to the boundary wire. The product will start to cut when it is at the boundary wire.

3.9.3.1 To redo the guide calibration

- Push the **Menu** button for 3 seconds to enter the *Quick info* menu.
- Use the **arrow** buttons and the **OK** button to move through the menu structure *Advanced > Calibrate > Guide calibration*.
- Place the product in the charging station.
- Push the **Start** button to start the automatic calibration.

3.10 To do the product settings

Use the display and the keypad on the product to set all settings for the product. You can access all functions through the menus. The functions have factory settings that are applicable for almost all work areas, but the settings can be adapted to the conditions for each work area.

Use the GARDENA Bluetooth® App for the products that do not have the GARDENA smart system to set settings and operation of the product. Refer to *To download and pair with the GARDENA Bluetooth® App on page 23*.

Use the GARDENA smart system app for the products that have the GARDENA smart system to set settings and operation of the product. Refer to *GARDENA smart system on page 29*.

3.10.1 To download and pair with the GARDENA Bluetooth® App

The GARDENA Bluetooth® App is a free app for your mobile device. The GARDENA Bluetooth® App is used for the settings and operation of the product. The short-range interaction with the product is called Bluetooth®. When pairing between the product and app has been confirmed, you have access to the menus and functions as long as you are within short-range (Bluetooth®).

1. Download the GARDENA Bluetooth® App on your mobile device.
2. Switch off the product and switch it on again.
3. Pair the GARDENA Bluetooth® App with the product.

Note: The Bluetooth® pairing mode is active for 3 minutes.

4. Enter the PIN code. Refer to *Introduction on page 3*.

3.10.2 Menu structure

The main menu contains:

- Schedule
- SensorControl
- Smart system (only for smart SILENO city and smart SILENO life)
- Settings

Refer to *Menu structure overview 1 on page 7* and *Menu structure overview 2 on page 8*.

3.10.3 To get access to the menu

1. Push the **STOP** button.
2. Use the up/down **arrow** buttons and the **OK** button to enter the PIN code.
3. Push the **MENU** button.

3.10.4 To do the schedule settings



You can set the schedule in 2 ways:

- Set the schedule by using the wizard. Refer to *Wizard on page 23*.
- Set the schedule in the Advanced menu. Refer to *To set the schedule on page 23*.

Note: The lawn should not be cut too often to obtain the best result. If the product is allowed to operate too much, the lawn may appear flattened. The product is also subjected to unnecessary wear.

3.10.4.1 Wizard

The wizard is a quick tool to find suitable schedule settings for your lawn.

1. Do steps 1–3 in *To get access to the menu on page 23*.
2. Use the **arrow** buttons and the **OK** button to move through the menu structure *Schedule > Wizard*.
3. Enter your estimated lawn size. It is not possible to enter a larger lawn size than the maximum work capacity.
4. Push the **OK** button to confirm the lawn size. By entering your lawn size the wizard suggests either a suitable daily schedule (refer to step 7) or need input for inactive days.
5. Choose what day(s) the product should be inactive. Use the up/down **arrow** buttons to shift between days.
6. Push the **OK** button to confirm the chosen inactive day(s).
7. The wizard suggests a daily schedule for the active days. If you want to move the schedule interval to earlier or later in the day then push the **arrow** buttons up or down.
8. Push the **OK** button to confirm the daily schedule. An overview of the daily schedule is presented. Push the **OK** button to go back to main menu.

Note: To change the schedule settings for individual work days use the *Schedule > Advanced* menu.

3.10.4.2 To set the schedule

1. Do steps 1–3 in *To get access to the menu on page 23*.
2. Use the **arrow** buttons and the **OK** button to move through the menu structure *Schedule > Advanced > Overview*.
3. Use the **arrow** buttons and the **OK** button to select the day.
4. Use the left **arrow** button to select the period.
5. Push the **OK** button.
6. Calculate the suitable operating hours. Refer to *Make an estimate of the necessary operating time on page 24*.
7. Enter the time with the **arrow** buttons. The product can cut the grass 1 or 2 periods each day.

MONDAY	
<input checked="" type="checkbox"/>	00:00 - 15:00
<input type="checkbox"/>	--:-- --:--
Copy	Reset

- If the product must not cut grass on a specified day, unselect the box adjacent to the 2 time periods.

3.10.4.3 Make an estimate of the necessary operating time

If the work area is less than maximum product capacity, the schedule must be set to decrease the wear on the lawn and the product. The product has a maximum cutting time each day. You can set the operating time of the product in the schedule. The operating time includes cutting, searching and charging. The operating time can be different because of many reasons, for example the layout of the work area, the grass growth and age of the battery. When the product has operated to the maximum cutting time in a day, the message *Today's mowing complete* is shown in the display of the product.

The recommended operating times for some work area examples are shown in the table below. If the result is not satisfactory, increase the operating time.

SILENO city	Area, m ²	Recommended operating time, h
	250	6-7
	500	13-15
	600	14-16

SILENO life	Area, m ²	Recommended operating time, h
	250	3-4
	500	7-8
	750	12-13
	1000	16-17
	1250	21-22
	1500	23-24

3.10.4.4 To copy the schedule setting

- Do steps 1–3 in *To get access to the menu on page 23*.
- Use the **arrow** buttons and the **OK** button to move through the menu structure *Schedule > Advanced > Overview > Copy*.
- Use the **arrow** buttons and the **OK** button to copy the schedule setting. You can copy the schedule settings day to day or for the full week.

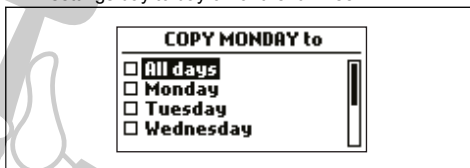

3.10.4.5 To reset the schedule setting

You can remove all schedule settings and use the factory setting.

- Do steps 1–3 in *To get access to the menu on page 23*.
- Use the **arrow** buttons and the **OK** button to move through the menu structure *Schedule > Advanced > Overview > Reset*.
 - Push the **arrow** buttons to select *Current day* to only reset the current day to factory settings.
 - Push the **arrow** buttons to select *All week* to reset all schedule settings to factory settings.
- Push the **OK** button.

3.10.5 SensorControl



SensorControl automatically adjust the cutting time to the growth of the grass. The product is not permitted to operate more than the schedule settings.

Note: When using *SensorControl*, it is recommended to make as much operating time as possible available for *SensorControl*. Do not restrict the schedule more than necessary.

The first operation of the day is set by the schedule settings. The product always complete 1 mowing cycle, and then *SensorControl* selects if the product will continue to operate or not.

Note: *SensorControl* is reset if the product does not operate for more than 50 hours, or if a *Reset of all user settings* is done. *SensorControl* is not changed if a *Reset of schedule settings* is done.

3.10.5.1 To set the SensorControl

- Do steps 1–3 in *To get access to the menu on page 23*.
- Use the **arrow** buttons and the **OK** button to move through the menu structure *SensorControl > Use SensorControl*.
- Push the **OK** button to select the *SensorControl*.
- Push the **BACK** button.

3.10.5.2 To set the SensorControl frequency

Set how frequently the product cuts the grass when the *SensorControl* is in use. There are 3 frequency levels: *Low*, *Mid* and *High*. The higher the frequency, the more sensitive the product is to the grass growth. That is, if the grass growth is high then the product is allowed to work longer.

Note: If the mowing results are not optimal when using *SensorControl*, the schedule settings may need adjusting. Do not restrict the schedule more than necessary. Also, check that the blade disc is clean and that the blades are in good condition.

1. Do steps 1–3 in *To get access to the menu on page 23*.
2. Use the **arrow** buttons and the **OK** button to move through the menu structure *SensorControl > Cutting time*.
3. Use the **arrow** buttons to select *Low*, *Mid* or *High* frequency.
4. Push the **BACK** button.

3.10.6 Security level



There are 2 security levels for SILENO city and 3 security levels for SILENO life.

Function	Low	Medium (SILENO life)	High
		High (SILENO city)	(SILENO life)
<i>Alarm</i>			X
<i>PIN-code</i>		X	X
<i>Time lock</i>	X	X	X

- *Alarm* - An alarm goes off if the PIN-code is not entered within 10 seconds after the **STOP** button is pushed. The alarm also goes off when the product is lifted. The alarm stops when the PIN-code is entered.
- *PIN-code* - The correct PIN-code must be entered to get access to the Menu structure of the product. If the incorrect PIN-code is entered 5 times, the product is locked for a time. The lock is extended for each new incorrect try.
- *Time lock* - The product locks if the PIN-code has not been entered in 30 days. Enter the PIN-code to get access to the product.

3.10.6.1 To set the security level

Select 1 of the security levels for your product.

1. Do steps 1–3 in *To get access to the menu on page 23*.
2. Use the **arrow** buttons and the **OK** button to move through the menu structure *Settings > Security > Security level*.

3. Use the **arrow** buttons and the **OK** button to select the level of security.
4. Push the **OK** button.

3.10.6.2 Security - Advanced

To make a new loop signal

The loop signal is randomly selected to create a unique link between the product and the charging station. In rare cases, there may be a need to make a new signal, for instance if two adjacent installations have very similar signals.

1. Put the product in the charging station.
2. Do steps 1–3 in *To get access to the menu on page 23*.
3. Use the **arrow** buttons and the **OK** button to move through the menu structure *Settings > Security > Advanced > New loop signal*.
4. Wait for confirmation that the loop signal has been made. This usually takes about 10 seconds.

To change the PIN-code

1. Do steps 1–3 in *To get access to the menu on page 23*.
2. Use the **arrow** buttons and the **OK** button to move through the menu structure *Settings > Security > Advanced > Change PIN-code*.
3. Enter the new PIN code.
4. Push the **OK** button.
5. Enter the new PIN code again.
6. Push the **OK** button.
7. Make a note of the new PIN code. Refer to *Introduction on page 3*.

3.10.7 Lawn Coverage and CorridorCut

If the work area includes remote parts that are connected with narrow passages, the *Lawn Coverage* and *CorridorCut* function are useful to be able to maintain a well-cut lawn in all parts of the yard. The *Lawn Coverage* function is used to guide the product to remote parts of the work area. The *CorridorCut* function is used for narrow passage mowing. A guide wire must be installed to use these functions. You can set a maximum of 3 remote areas.

With the *Lawn Coverage* function the product first follows and then leaves the guide wire after a certain distance and starts to mow the lawn.

The *CorridorCut* function is suitable to mow narrow passages of 60 cm - 1.5 m / 23 in. - 4.9 ft. width. The product moves in a pattern to cover the passage width. The product starts the *CorridorCut* at the set distance from the charging station. When the product reaches the end of the narrow passage, the product continues and cuts the lawn as normal.

Area A, approximately 50%

Area B, approximately 30%

Area C, approximately 20%

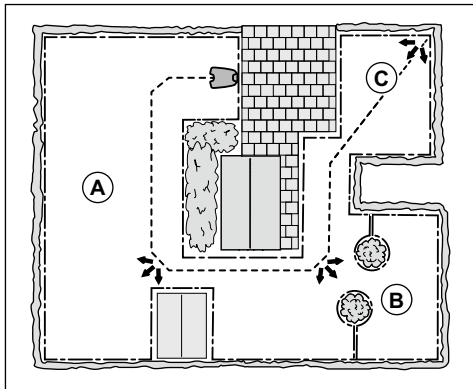

3.10.7.1 To set the Lawn Coverage function

1. Do steps 1–3 in *To get access to the menu on page 23*.
2. Use the **arrow** buttons and the **OK** button to move through the menu structure *Settings > Lawn Coverage > Area 1-3*.
3. Use the **arrow** button to select the area.
4. Push the **OK** button.
5. Measure the distance from the charging station to the start of the area. Measure along the guide wire. Refer to *To measure the distance from the charging station on page 26*.
6. Push the **arrow** buttons to select the distance, measured in m.
7. Push the **OK** button.
8. Use the **arrow** buttons to select the percentage of the cutting time the product must cut the area. The percentage is equal to the percentage of the area in relation to the complete work area.
 - a) Measure the area.
 - b) Divide the measured area with the total work area.
 - c) Convert the result to percentage.

Note: The sum of Area 1-3 must be 100% or less. If the sum is less than 100%, the product sometimes straddles the guide wire and starts to mow at the starting point. Refer to *Starting point on page 27*.

9. Push the **BACK** button.

3.10.7.2 To set the CorridorCut function

Note: To prevent that the grass in the narrow passage is worn, GARDENA recommends to set a low percentage for the *CorridorCut*.

1. Do steps 1–3 in *To get access to the menu on page 23*.
2. Use the **arrow** buttons and the **OK** button to move through the menu structure *Settings > Lawn Coverage > Area 1-3*.
3. Use the **arrow** buttons to select the area.
4. Push the **OK** button.
5. Measure the distance from the charging station to the beginning of the narrow passage. Measure along the guide wire. Refer to *To measure the distance from the charging station on page 26*.

Note: Make sure that the distance to the *CorridorCut* is set inside the narrow passage.

6. Push the **arrow** buttons to select the distance.
7. Push the **OK** button.
8. Use the **arrow** buttons to select the % of the cutting time that the product must start the narrow passage cutting.
9. Use the **arrow** buttons and the **OK** button to select *More > CorridorCut*.
10. Push the **OK** button to enable *CorridorCut*.
11. Push the **BACK** button.

3.10.7.3 To do a test of the Lawn Coverage function

1. Put the product in the charging station.
2. Do step 1-3 in *To get access to the menu on page 23*.
3. Use the **arrow** buttons and the **OK** button to move through the menu structure *Settings > Lawn Coverage > Area 1-3 > More > Test*.
4. Push the **OK** button.
5. Push the **START** button.
6. Close the hatch.
7. Make sure the product can find the area.

3.10.7.4 To measure the distance from the charging station

1. Put the product in the charging station.
2. Do steps 1–3 in *To get access to the menu on page 23*.
3. Use the **arrow** buttons and the **OK** button to move through the menu structure *Settings > Lawn Coverage > Area 1-3 > How far?*
4. Use the **arrow** buttons to set 500 m / 540 yd as a distance.

5. Push the **OK** button.
6. Use the **arrow** buttons and the **OK** button to move through the menu structure *Settings > Lawn Coverage > Area 1-3 > More > Test*.
7. Push the **OK** button.
8. Push the **STOP** button when the product is at the distance you select to measure. The distance shows in the display.

3.10.7.5 To disable or enable the Lawn Coverage function

Disable or enable the *Lawn Coverage* function for each area.

1. Do steps 1–3 in *To get access to the menu on page 23*.
2. Use the **arrow** buttons and the **OK** button to move through the menu structure *Settings > Lawn Coverage > Area 1-3 > Disable*.
3. Push the **OK** button.
4. Push the **BACK** button.

3.10.7.6 To reset the Lawn Coverage settings

You can reset the *Lawn Coverage* settings for each area and use the factory setting.

1. Do steps 1–3 in *To get access to the menu on page 23*.
2. Use the **arrow** buttons and the **OK** button to move through the menu structure *Settings > Lawn Coverage > Area 1-3 > More > Reset*.
3. Push the **OK** button.

3.10.8 Starting point

This function allows you to control how far the product drives along the guide wire from the charging station before it starts operating. The factory setting is 60 cm / 2 ft, and the maximum distance is 300 cm / 10 ft.

Note: The product straddles the guide wire from the charging station to the starting point. Keep as short distance to the starting point as possible to reduce the risk of tracks forming on the lawn.

If the charging station is placed in a limited space area, for example between flower beds, choosing a good starting point is important so that the guide calibration process is optimized. Refer to *Guide calibration on page 22*.

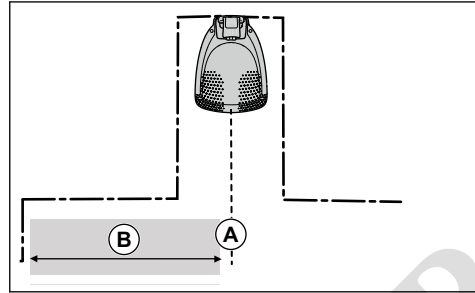

A) Starting point

B) Minimum distance 60 cm / 2 ft (perpendicular to the guide wire). If less distance, the calibration process is interrupted. For the widest possible guide corridor, have a minimum distance of 1.35 m / 4.5 ft. Refer to *Guide calibration on page 22*.

3.10.8.1 To set the starting point

1. Do steps 1-3 in *To get access to the menu on page 23*.
2. Use the **arrow** button and the **OK** button to move through the menu structure *Settings > Installation > Starting point*.
3. Use the **arrow** buttons to specify the distance in cm.
4. Push the **BACK** button.

3.10.9 Drive Past Wire function

The front of the product always moves past the boundary wire by a specified distance. Then the product moves rearward and changes direction. The factory setting is 32 cm / 12 in. You can select a distance of 20-40 cm / 8-15 in.

Note: If you change the distance for *Drive Past Wire*, the distance will change along the boundary wire in all parts of the work area.

3.10.9.1 To set the Drive Past Wire function

1. Do steps 1–3 in *To get access to the menu on page 23*.
2. Use the **arrow** button and the **OK** button to move through the menu structure *Settings > Installation > Drive Past Wire*.
3. Use the **arrow** buttons to set the distance.
4. Push the **BACK** button.

3.10.10 ECO mode

If *ECO mode* is activated, it switches off the signal in the boundary loop, the guide wire and the charging station, when the product is parked or is charging.

Note: Use *ECO mode* to save energy and avoid interference with other equipment, for example hearing loops or garage doors.

Note: To start the product manually in the work area, push the **STOP** button before you remove the product from the charging station. If not, the product cannot be started in the work area.

3.10.10.1 To set the ECO mode

1. Do steps 1–3 in *To get access to the menu on page 23*.
2. Use the **arrow** buttons and the **OK** button to move through the menu structure *Settings > Installation > ECO mode*.
3. Push the **OK** button to select the *ECO mode*.
4. Push the **BACK** button.

3.10.11 To avoid collisions with GARDENA mower house

If you have installed a GARDENA mower house (available as accessory), the wear on the product and the mower house decreases when you select *Avoid house collisions*.

1. Do steps 1–3 in *To get access to the menu on page 23*.
2. Use the **arrow** buttons and the **OK** button to move through the menu structure *Settings > Installation > Mower house > Avoid house collisions*.
3. Push the **BACK** button.

Note: If *Avoid house collisions* is selected it can result in grass that is not cut around the charging station.

3.10.12 Frost Sensor

The grass is extra sensitive to wear if the yard is covered with frost. If the *Frost Sensor* is activated, the product is not allowed to start to cut the grass if the temperature is below 5° C / 41° F.

Note: The frost sensor is located inside the chassis and there can be a delay compared to the ambient temperature.

3.10.12.1 To set the Frost Sensor

1. Do steps 1–3 in *To get access to the menu on page 23*.
2. Use the **arrow** buttons and the **OK** button to move through the menu structure *Settings > Installation > Frost Sensor*.
3. Push the **OK** button to select *Frost Sensor*.

4. Push the **BACK** button.

3.10.13 ZoneProtect

If you install the ZoneProtect accessory, you must enable the Zone generator function of the product.

3.10.13.1 To enable the Zone generator function

1. Do steps 1–3 in *To get access to the menu on page 23*.
2. Use the **arrow** buttons and the **OK** button to move through the menu structure *Settings > Installation > Zone generator*.
3. Push the **OK** button to enable *Zone generator*.
4. Push the **BACK** button.

3.10.14 General

In *General* you can change the general settings of the product.

3.10.14.1 To set the time & date

1. Do steps 1–3 in *To get access to the menu on page 23*.
2. Use the **arrow** buttons and the **OK** button to move through the menu structure *Settings > General > Time & Date*.
3. Use the **arrow** buttons to set the time and then push the **BACK** button.
4. Use the **arrow** buttons to set the date and then push the **BACK** button.
5. Use the **arrow** buttons to set the time format and then push the **BACK** button.
6. Use the **arrow** buttons to set the date format and then push the **BACK** button.

3.10.14.2 To set the language

1. Do steps 1–3 in *To get access to the menu on page 23*.
2. Use the **arrow** buttons and the **OK** button to move through the menu structure *Settings > General > Language*.
3. Use the **arrow** buttons to select language and then push the **BACK** button.

3.10.14.3 To set the country

1. Do steps 1–3 in *To get access to the menu on page 23*.
2. Use the **arrow** buttons and the **OK** button to move through the menu structure *Settings > General > Country*.
3. Use the **arrow** buttons to select country and then push the **BACK** button.

3.10.14.4 To set the unit format

1. Do steps 1–3 in *To get access to the menu on page 23*.

- Use the **arrow** buttons and the **OK** button to move through the menu structure *Settings > General > Unit format*.
- Use the **arrow** buttons to select unit format and then push the **BACK** button.

3.10.14.5 To reset all user settings

- Do steps 1–3 in *To get access to the menu on page 23*.
- Use the **arrow** buttons and the **OK** button to move through the menu structure *Settings > General > Reset all user settings*.
- Use the right **arrow** button to select *Proceed with reset of all user settings?*
- Push the **OK** button to reset all the user settings.

Note: *Security level, PIN code, Loop signal, Messages, Date & Time, Language and Country settings* are not reset.

3.10.14.6 The About menu

The *About* menu displays information about the product, for example serial number and firmware versions.

3.10.15 GARDENA smart system



Only for smart SILENO city and smart SILENO life.

Note: Make sure that the smart product is fully installed in the work area before you include it into the GARDENA smart system app. Refer to *Installation on page 14*.

The product can connect to mobile devices that have the GARDENA smart system app installed. The GARDENA smart system makes it possible with wireless interaction between your smart product and the GARDENA smart system.

In the smart system menu in the product you can:

- enable your smart product to include with or exclude from the GARDENA smart system app.
- check the status of the wireless connection to the smart system.

When the smart product is part of the smart system, some menus in the product display are disabled. You can still see all of the settings in the product but some can only be changed with the GARDENA smart system app. The following settings are blocked in the menu selection of the smart product:

- Schedule
- Time & Date

- Language
- Country

3.10.15.1 To set the Activate Inclusion Mode

In order to include your smart product into the GARDENA smart system app:

- Do steps 1–3 in *To get access to the menu on page 23*.
- Use the **arrow** buttons and the **OK** button to enter the menu *smart system*.
- Use the right **arrow** button and the **OK** button to select *Yes to Activate Inclusion Mode*.
- Use the up/down **arrow** buttons to enter the PIN code and push the **OK** button.
- The inclusion code is shown in the product display.
- Follow the instructions in the GARDENA smart system app.

The inclusion sequence might take several minutes. Once the inclusion has succeeded you will automatically return to the product start screen. If the inclusion by any reason fails, try again.

3.10.15.2 Inclusion in the App

The inclusion of all GARDENA smart devices takes place over the smart system app.

To download the GARDENA smart system app

- Download the GARDENA smart system app from App Store or Google Play.
- Open the app and register as a user.
- Log in and choose *Include device* from the start page in the app.
- Follow the instructions in the app.

Note: The smart gateway needs internet connection to be able to include the product to the app.

3.10.15.3 To select Exclude device

If you exclude the device, there will be no communication between the product and the GARDENA smart system.

- Do steps 1–3 in *To get access to the menu on page 23*.
- Use the **arrow** buttons and the **OK** button to move through the menu structure *smart system > Exclude device*.
- Push the **OK** button.

Note: The product must be manually deleted from the list of products in the GARDENA smart system app.

3.10.15.4 To do a check of the status for GARDENA smart system

When the product is connected to smart system gateway, you can do a check of the connection status.

1. Do steps 1–3 in *To get access to the menu on page 23*.
2. Use the **arrow** buttons and the **OK** button to move through the menu structure *smart system > Status*.

Note: The *Status* is either connected *Yes* or not connected *No*. The *Signal strength* is either *Good*, *Poor* or *Bad*. Put the charging station in a location with *Signal strength - Good*, for the best smart system performance.



МАГАЗИН
БАШ МАЙСТОРА[®]
ПРОФЕСІОНАЛНИ РЕШЕНИЯ

4 Operation

4.1 To use the ON/OFF button



WARNING: Read and understand the safety chapter before you use the product.



WARNING: Keep your hands and feet away from the rotating blades. Do not put your hands or feet near or below the product when the product is set to ON.



WARNING: Do not use the product when persons, especially children, or animals are in the work area.

- Push the **ON/OFF** button for 3 seconds to set the product to ON. Make sure that the LED indicator comes on.
- The product is ON and in power save mode if the LED indicator flashes. Push the **ON/OFF** button for 3 seconds to set the product to ON.

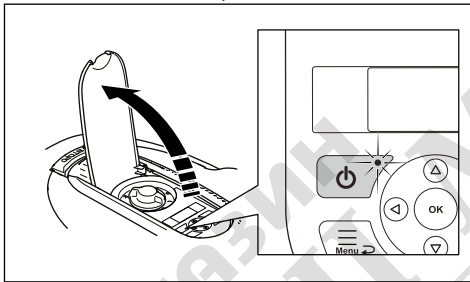

- Push the **ON/OFF** button for 3 seconds to set the product to OFF. Make sure that the LED indicator goes out.

4.2 To start the product

1. Open the hatch to the keypad.
2. Push the **ON/OFF** button for 3 seconds. The display is lit up.
3. Use the up/down **arrow** buttons and the **OK** button to enter the PIN code.

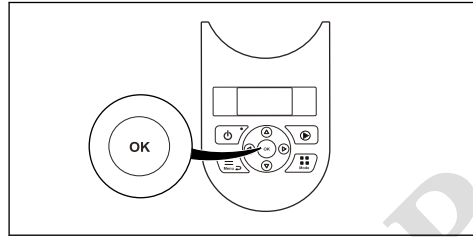

4. Select the desired operating mode and confirm with the **OK** button. Refer to *Operating modes* on page 31.
5. Close the hatch.

Note: The first weeks after installation the perceived sound level when cutting the grass may be higher than expected. When the product has cut the grass for some time, the perceived sound level is much lower.

4.3 Operating modes

Push the **Mode** button to select the following operating modes:

- *Main area*
- *Secondary area*
- *Park*
- *Park / Schedule*
- *Override schedule*
- *Spot cutting*

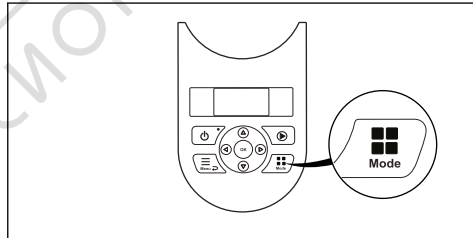

4.3.1 Main area

Main area is the standard operating mode where the product mows and charges automatically.

4.3.2 Secondary area

To mow secondary areas the operating mode *Secondary area* must be selected. In this mode, the operator must move the product manually between the main area and the secondary area. The product mows until the battery is empty. When the battery is empty, put the product in the charging station to charge the battery.

When the battery is charged, the product moves out of the charging station and stops. The product is now prepared to start operation, but needs confirmation from the operator first.

Note: Put the product in the charging station and change the operating mode to *Main area* in the app or with the keypad on the product if you want to cut the main area after the battery is charged.

4.3.3 Park

Operating mode *Park* means that the product returns to the charging station where it remains until a different operating mode is selected.

4.3.4 Park / Schedule

Operating mode *Park / Schedule* means that the product goes back to the charging station where it stays until the next schedule. If the product has operated the maximum cutting time for the day, it will start to operate again the next day. Refer to *Make an estimate of the necessary operating time on page 24*.

4.3.5 Override schedule

Select *Override schedule* to temporarily override the schedule settings. You can select to override the schedule settings for 3 hours. The product cannot be set to cut more than the maximum cutting time for each day.

4.3.6 Spot cutting

The *Spot cutting* function is activated with the **START** button and is useful for quickly mowing an area where the grass has been mown less than in other parts of the yard. You must manually move the product to the chosen area.

Spot cutting means that the product mows in a spiral pattern in order to cut the grass in the area where it was started. When this is done, the product automatically switches back to *Main area* or *Secondary area*.

4.4 To stop the product

1. Push the **STOP** button to make the product and the cutting motor stop.

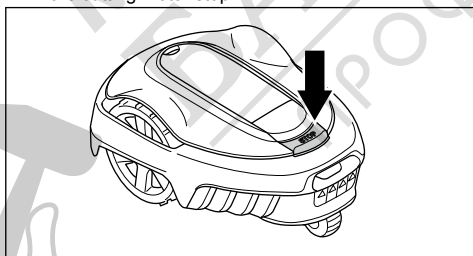

4.5 To set the product to OFF

1. Push the **STOP** button to open the hatch.

2. Push the **ON/OFF** button for 3 seconds.
3. Make sure that the LED indicator on the keypad is off to make sure that the product is set to OFF.

4.6 To charge the battery



WARNING: Only charge the product using a charging station which is intended for it. Incorrect use may result in electric shock, overheating or leakage of corrosive liquid from the battery.

In the event of leakage of electrolyte flush with water and seek medical help if it comes in contact with the eyes etc.

When the product is new or has been stored for a long period, the battery can be empty and must be charged before you can start the product. In the *Main area* mode, the product cuts and charges automatically.

1. Push the **ON/OFF** for 3 seconds button to start the product.
2. Put the product in as far as possible in the charging station.
3. Make sure that the charging plates on the charging station connects to the contact plates on the product.
4. Do a check that the display shows the message *CHARGING* to make sure that the product is connected correctly to the charging station.

4.7 Adjust the cutting height



CAUTION: During the first weeks after a new installation, the cutting height must be set to MAX to avoid damaging the loop wire. After this, the cutting height can be lowered step by step every week until the desired cutting height has been reached.

The cutting height can be varied from MIN (2 cm / 0.8 in.) to MAX (5 cm / 2 in.).

4.7.1 To adjust the cutting height

1. Push the **STOP** button to stop the product.
2. Open the hatch.

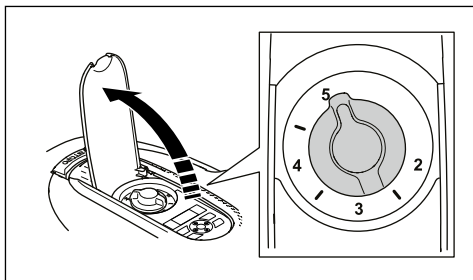

3. Turn the cutting height adjustment knob to select a cutting height.
 - a) Turn clockwise to increase the cutting height.
 - b) Turn counterclockwise to decrease the cutting height.



МАГАЗИН
БАШ МАЙСТОРА®
ПРОФЕСИОНАЛНИ РЕШЕНИЯ

5 Maintenance

5.1 Introduction - maintenance



WARNING: The product must be switched off before any maintenance is done. The product is disabled when the LED status indicator is not lit.



WARNING: Wear protective gloves.

For better operation and longer service life, make sure to clean the product regularly and replace worn parts. All maintenance and servicing must be done according to GARDENA's instructions. Refer to *Warranty on page 53*.

When the product is first used, the blade disc and blades should be inspected once a week. If the amount of wear during this period has been low, the inspection interval can be increased.

It is important that the blade disc rotates easily. The edges of the blades should not be damaged. The lifetime of the blades varies immensely and depends for instance on:

- Operating time and size of the work area.
- Type of grass and seasonal growth.
- Soil, sand and use of fertilizers.
- The presence of objects such as cones, windfalls, toys, tools, stones, roots and the like.

The normal life is 4 to 7 weeks when used under favorable conditions. Refer to *To replace the blades on page 35* on how to replace the blades.

Note: Working with blunt blades gives a poorer mowing result. The grass is not cut cleanly and more energy is needed resulting in the product not mowing such a large area.

5.2 Clean the product



CAUTION: Do not use a high-pressure washer to clean the product. Do not use solvents for cleaning.

The product does not operate satisfactorily in slopes if the wheels are blocked with grass. Use a soft brush to clean the product.

GARDENA recommends to use a special cleaning and maintenance kit as an accessory. Speak to your GARDENA service.

5.2.1 Chassis and blade disc

Inspect the blade disc and blades once a week.

1. Push the **STOP** button.
2. Push the **ON/OFF** button for 3 seconds to switch off the product.
3. Check that the indicator lamp on the keypad is not lit.
4. If the product is dirty, clean it by using a brush or a water hose. Do not use a high-pressure washer.
5. Lift the product onto its side.
6. Clean the blade disc and chassis using for example a dish brush. At the same time, check that the blade disc rotates freely in relation to the foot guard. Also, check that the blades are intact and can pivot freely.

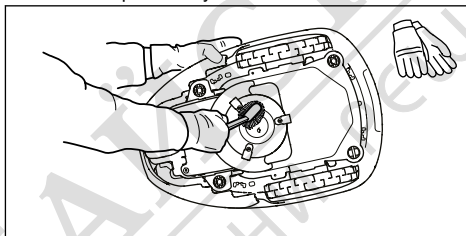

5.2.2 Wheels

Clean around the wheels. Grass on the wheels can impact on how the product performs in slopes.

5.2.3 The body of the product

Use a moist, soft sponge or cloth to clean the body of the product. If the body of the product is dirty, use a mild soap solution to clean it.

5.2.4 Charging station



WARNING: Disconnect the power supply from the power outlet before any maintenance, or cleaning of charging station or power supply.



WARNING: Do not use a high-pressure washer or running water to clean the charging station.

Clean the charging station regularly from grass, leaves, twigs and other objects that may impede docking.

5.3 Replace the blades



WARNING: Use blades and screws of the right type. GARDENA can only guarantee safety when using original blades. Only replacing the blades and reusing the screw can result in a screw wearing during mowing. The blades can then be propelled from under the body and cause serious injury.

Replace worn or damaged parts for safety reasons. Even if the blades are intact, they should be replaced on a regular basis for the best mowing result and low energy usage. All 3 blades and screws must be replaced at the same time to obtain a balanced cutting system. Use GARDENA original blades embossed with the crowned H-mark logotype, refer to *Warranty on page 53*.

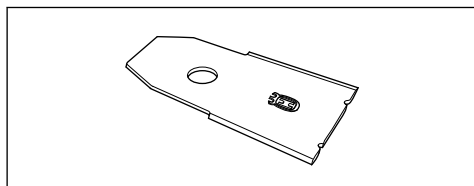

5.3.1 To replace the blades

1. Push the **STOP** button.
2. Open the hatch.
3. Push the **ON/OFF** button for 3 seconds to switch off the product.

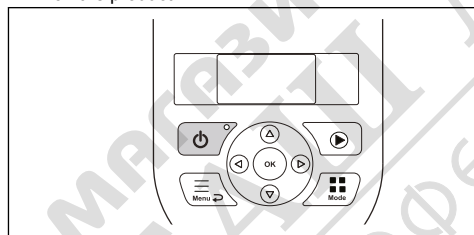

4. Check that the indicator lamp on the keypad is not lit.
5. Turn the product upside down. Place the product on a soft and clean surface to avoid scratching the body and the hatch.
6. Remove the 3 screws. Use a straight slot or cross-tip screwdriver.

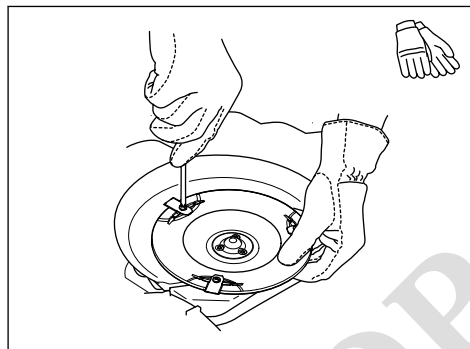

7. Remove each blade and screw.
8. Fasten new blades and screws.
9. Check that the blades can pivot freely.

5.4 Firmware update

If service is done by GARDENA service, available firmware updates are downloaded to the product by the service technician. Owners of GARDENA products can update the firmware if this is initiated by GARDENA. Registered users are in that case notified.

5.4.1 To update the firmware

1. Open the battery hatch. Refer to *To replace the battery on page 36*.
2. Plug in a USB printer cable (USB A and USB B contacts) in the product and your computer. The USB printer cable is available as an accessory.

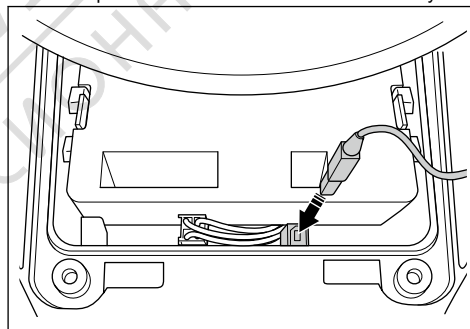

3. Go to www.gardena.com, search for and download the firmware update tool and follow the instructions.
4. Remove the USB printer cable and close the battery hatch.

5.4.2 To update the GARDENA Bluetooth® App and the GARDENA smart system app

GARDENA regularly updates the GARDENA Bluetooth® App and the GARDENA smart system app.

- Update the app on App Store or on Google Play to make sure that you have the newest firmware update.

5.5 Battery



WARNING: Only charge the product using a charging station which is intended for it. Incorrect use may result in electric shock, overheating or leakage of corrosive liquid from the battery. In the event of leakage of electrolyte flush with water and seek medical help if it comes in contact with the eyes etc.



WARNING: Use only original batteries recommended by the manufacturer. Product safety cannot be guaranteed with other batteries. Do not use non-rechargeable batteries.



CAUTION: The battery must charge a complete cycle before winter storage. If the battery is not fully charged it can be damaged and in certain cases be rendered useless.

If the operating time for the product is shorter than normal between charges, this indicates that the battery is getting old and eventually needs replacing.

Note: Battery life is dependent on the length of the season and how many hours a day the product is operating. A long season or many hours of use a day means that the battery must be replaced more regularly. The battery is fine as long as the product maintains a well-cut lawn.

5.5.1 To replace the battery



WARNING: The product must be disconnected from the supply mains when removing the battery.

1. Push the **ON/OFF** button for 3 seconds to switch off the product. Check that the indicator lamp on the keypad is not lit.
2. Set the cutting height to MIN.
3. Turn the product upside down. Place the product on a soft and clean surface to avoid scratching the body and the display cover.
4. Clean around the battery cover.

5. Unscrew the screws to the battery cover (Torx 20) and remove the battery cover.

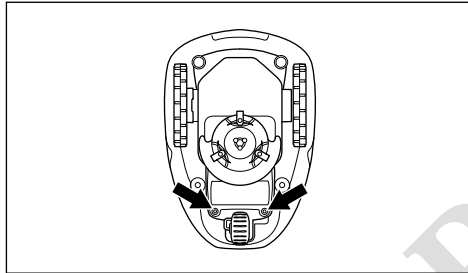

6. Release the latch of the connector (A) and pull it upwards.

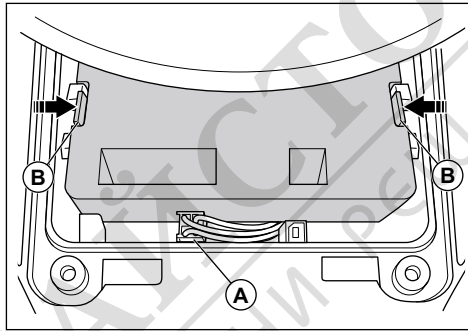

CAUTION: Do not pull the cables.

7. Release the latch of the battery and lift up the battery (B).
8. Put the new battery into place in the product.

Note: Fit the battery cover without clamping the cables. If the seal on the battery cover is visibly damaged, the entire battery cover must be replaced.

9. Connect the cable.
10. Carefully tighten screws for the battery cover (Torx 20).

5.6 Winter service

Take your product to your GARDENA central service for service prior to winter storage. Regular winter service will maintain the product in good condition and create the best conditions for a new season without any disruptions.

Service usually includes the following:

- Thorough cleaning of the body, the chassis, the blade disc and all other moving parts.

- Testing of the product's function and components.
- Checking and, if required, replacing wear items such as blades and bearings.
- Testing the product's battery capacity as well as a recommendation to replace battery if necessary.
- If new firmware is available, the product is updated.



МАГАЗИН
БАШ МАЙСТОРА®
ПРОФЕСИОНАЛНИ РЕШЕНИЯ

6 Troubleshooting

6.1 Introduction - troubleshooting

In this chapter you can find information and help about faults and symptoms of the product. You can find more information and FAQ (Frequently Asked Questions) on www.gardena.com.

6.1.1 To get access to the Quick info menu

Technical data, values and information about the history of the product can be found in the *Quick info* menu. If you speak to GARDENA central service for a solution to

a problem, they can tell you to access the information that is available in this menu.

- Push the **Menu** button for 3 seconds to enter the *Quick info* menu.

6.2 Fault messages

The fault messages in the table below are shown in the display of the product. Speak to your GARDENA representative if the same message shows frequently.

Message	Cause	Action
<i>Wheel motor blocked, left/right</i>	Grass or other object around the drive wheel.	Remove grass or other object.
<i>Cutting system blocked</i>	Grass or other object around the blade disc.	Remove grass or other object.
	The blade disc is in water.	Move the product and prevent the collection of water in the work area.
	The grass is too high.	Cut the grass before you install the product. Make sure that the grass is maximum 4 cm / 1.6 in.
<i>Trapped</i>	The product is behind a number of obstacles in a small area.	Remove the obstacles or put the boundary wire around the obstacle to make an island. Refer to <i>To make an island on page 17</i> .
<i>Outside working area</i>	A section of boundary wire is put across the other section of boundary wire to the charging station.	Make sure that the boundary wire is connected correctly.
	The boundary wire is too near the edge of the work area.	Make sure that the boundary wire is installed correctly. Refer to <i>To install the boundary wire on page 20</i> .
	The work area slopes much by the boundary loop.	
	The boundary wire is put in the incorrect direction around an island.	
	Interference to the boundary wire from metal objects such as fences, reinforcement steel or buried cables nearby.	Move the boundary wire.
The product cannot find the correct loop signal because of interference with a loop signal from a different product installation nearby.	Put the product in the charging station and generate a new loop signal.	

Message	Cause	Action
<i>Empty battery</i>	The product cannot find the charging station.	Change the position of the guide wire. Refer to <i>To install the guide wire on page 20</i> .
	The battery is at the end of its life cycle.	Replace the battery. Refer to <i>Battery on page 36</i> .
	The antenna of the charging station is defective.	Do a check if the indicator lamp in the charging station flashes red. Refer to <i>Indicator lamp in the charging station on page 44</i> .
	The charging plates on the product or contact plates on the charging station are defective because of corrosion.	Clean the charging and contact plates using a fine grade emery cloth. If the problem stays speak to your authorized service technician.
<i>Wrong PIN code</i>	Incorrect PIN code has been entered. 5 tries are permitted to enter the correct PIN code, and then the keypad is blocked for a period of time.	Enter the correct PIN code. If you do not know the correct PIN code, go to www.gardena.com to get information about how to get the PIN code or speak to your GARDENA service.
<i>No drive</i>	The product has got caught in something and has been slipping.	Free the product and correct the cause of problem. If it is because of wet grass, wait until the lawn is dry before you use the product.
	The work area includes a steep slope.	Steep slopes must be isolated. Refer to <i>To examine where to put the boundary wire on page 15</i> .
	The guide wire is not put diagonally in the slope.	Make sure that the guide wire is installed diagonally across the slope. Refer to <i>To examine where to put the guide wire on page 18</i> .
<i>Wheel motor overloaded, left/right</i>	Grass or other object around the drive wheel.	Remove grass or object from the drive wheel.
<i>Collision sensor problem, front/rear</i>	The product body cannot move freely around its chassis.	Make sure that the product body can move freely around its chassis. If the problem stays speak to your authorized service technician.
<i>Alarm! Mower switched off</i>	The alarm has started because the product had been switched off.	Adjust the security level in the <i>Security</i> menu. Refer to <i>Security - Advanced on page 25</i> .
<i>Alarm! Mower stopped</i>	The alarm has started because the product has been stopped.	
<i>Alarm! Mower lifted</i>	The alarm has started because the product has been lifted.	
<i>Alarm! Mower tilted</i>	The alarm has started because the product has been tilted.	



Message	Cause	Action
<i>Charging station blocked</i>	The contact between the charging plates on the product and the contact plates on the charging station is not good. The product has made a number of tries to charge.	Put the product in the charging station and make sure that the charging plates and contact plates are connected.
	An object prevents the product to enter the charging station.	Remove the object.
	The charging station is tilted or bent.	Put the baseplate on level ground.
	The guide wire is not installed correctly.	Install the guide wire correctly. Refer to <i>To install the guide wire on page 20.</i>
<i>Stuck in charging station</i>	An object prevents the product to move out from the charging station.	Remove the object.
<i>Upside down</i>	The product is in an incorrect position, the product is tilting too much or is upside down.	Put the product in the correct position.
<i>Needs manual charging</i>	The product is set to the <i>Secondary area</i> operating mode.	Put the product in the charging station.
<i>Next start hh:mm</i>	The schedule setting prevents the product from operating.	Change the schedule settings. Refer to <i>To do the schedule settings on page 23.</i>
	The product has operated the maximum cutting time for the day.	Usual operation of the product.
	The time or date in the product is not correct.	Set the time or date. Refer to <i>To set the time & date on page 28.</i>
<i>Today's mowing completed</i>	The product has operated the maximum cutting time for the day.	Usual operation of the product. Refer to <i>Make an estimate of the necessary operating time on page 24.</i>
<i>Lifted</i>	The lift sensor has been enabled because the product has been lifted.	Make sure that the product body can move freely around its body. Remove or create an island around objects that can cause the product body to be lifted. If the problem stays speak to your authorized service technician.
<i>Wheel drive problem, right/left</i>	Grass or other object around the drive wheel.	Clean the wheels and around the wheels.
<i>Electronic problem</i>	Temporary electronic or firmware related problem in the product.	Restart the product. If the problem stays speak to your authorized service technician.
<i>Loop sensor problem, front/rear</i>		
<i>Tilt sensor problem</i>		
<i>Temporary problem</i>		
<i>Invalid sub-device combination</i>		
<i>Temporary battery problem</i>		
<i>Safety function faulty</i>		
<i>Charging system problem</i>	Incorrect type of battery.	Use original batteries recommended by the manufacturer.

Message	Cause	Action
<i>Battery problem</i>	Temporary battery or firmware related problem in the product.	Restart the product. If the problem stays speak to your authorized service technician.
	Incorrect type of battery.	Use original batteries recommended by the manufacturer.
<i>Battery temperature outside limits</i>	The temperature in the battery is too high or too low to start operation.	The product will start to operate when the temperature is in limits.
<i>Charging current too high</i>	Incorrect or defective power supply unit.	Restart the product. If the problem stays speak to your authorized service technician.
<i>Connectivity problem</i>	Problem on the connectivity circuit board in the product.	Restart the product. If the problem stays speak to your authorized service technician.
<i>Connectivity settings restored</i>	The connectivity settings was restored because of a fault.	Do a check of the connectivity settings and change the settings if necessary.
<i>Poor signal quality</i>	The connectivity circuit board in the product is assembled incorrectly.	Examine if the connectivity circuit board is assembled correctly. If the problem stays speak to your authorized service technician.
	The product is in an incorrect position, the product is tilting too much or is upside down.	Put the product in the correct position.



Message	Cause	Action
<i>No loop signal</i>	The power supply or low-voltage cable are not connected.	If the LED status indicator on the charging station is not lit, it shows that there is no power. Examine the power outlet connection and the residual-current device. Make sure that the low-voltage cable is connected to the charging station.
	The power supply or low-voltage cable are damaged or not connected.	Replace the power supply or low-voltage cable.
	The boundary wire is not connected to the charging station.	Connect the boundary wire to the charging station. Replace the connectors if damaged. Refer to <i>To install the boundary wire on page 20</i> .
	The boundary wire is damaged.	Do a check of the LED status indicator on the charging station. If it shows damage in the boundary wire, replace the damaged section with new boundary wire.
	The product has tried to start but it is not in the charging station and <i>ECO mode</i> is enabled.	Put the product in the charging station, start the product and close the hatch.
	A section of the boundary wire is across the other section of boundary wire to and from an island.	Install the boundary wire in the correct direction around the island. Refer to <i>To install the boundary wire on page 20</i> .
	Problem with the pairing between the product and the charging station.	Put the product in the charging station and make a new loop signal. Refer to <i>To make a new loop signal on page 25</i> .
	Interference from metal objects such as fences, reinforcement steel or buried cables nearby.	Move the boundary wire and/or make islands in the work area to increase the signal strength.
	The product is too far from the boundary wire.	Install the boundary wire to make all parts of the work area maximum 15 m / 50 ft. from the boundary wire.
<i>Mower tilted</i>	The product is tilted more than the maximum angle.	Move the product to a level area.
<i>Connection NOT changed</i>	The loop signal was not changed because of an error.	Make a <i>New loop signal</i> a number of times. Refer to <i>To make a new loop signal on page 25</i> . If the problem stays speak to your authorized service technician.
<i>Zone generator problem</i>	The battery of the ZoneProtect accessory is low. The ZoneProtect does not operate when the battery is empty. The product can cut in the stay-out zone if you start the product before you charge the ZoneProtect.	Park the product and charge the ZoneProtect accessory before you start the product.
	The temperature in the ZoneProtect accessory is a higher than the maximum limit and is set to off.	Put the product in an area with protection from the sun. Let the temperature of the ZoneProtect accessory decrease before you start the product.

6.3 Information messages

The information messages in the table below are shown in the display of the product. Speak to your GARDENA representative if the same message shows frequently.

Message	Cause	Action
<i>Low battery</i>	The product cannot find the charging station.	Change the position of the guide wire. Refer to <i>To install the guide wire on page 20</i> .
	The battery is at the end of its life cycle.	Replace the battery. Refer to <i>Battery on page 36</i> .
	The antenna of the charging station is defective.	Do a check if the indicator lamp in the charging station flashes red. Refer to <i>Indicator lamp in the charging station on page 44</i> .
	The charging plates on the product or contact plates on the charging station are defective because of corrosion.	Clean the charging and contact plates using a fine grade emery cloth. If the problem stays speak to your approved servicing dealer.
<i>Settings restored</i>	A <i>Reset all user settings</i> has been done.	Usual operation of the product.
<i>Guide not found</i>	The guide wire is not connected to the charging station.	Connect the guide wire to the charging station. Refer to <i>To install the guide wire on page 20</i> .
	Damage in the guide wire.	Replace the damaged section with new guide wire.
	The guide wire is not connected to the boundary loop.	Connect the guide wire correctly to the boundary loop. Refer to <i>To install the guide wire on page 20</i> .
<i>Guide calibration failed</i>	The product has not calibrated the guide wire because of an error.	Install the guide wire correctly. Refer to <i>To install the guide wire on page 20</i> .
<i>Guide calibration done</i>	The product has calibrated the guide wire.	Usual operation of the product.
<i>Connection changed</i>	New loop signal changed.	Usual operation of the product.



6.4 Indicator lamp in the charging station

The indicator lamp in the charging station must show a solid or flashing green light for a correct installation. If not, follow the instructions in the troubleshooting table below.

Speak to your GARDENA service for more information.

Light	Cause	Action
Green solid light	Good signals.	Usual operation of the product.
Green flashing light	The signals are good and <i>ECO mode</i> is enabled.	Usual operation of the product. Refer to <i>ECO mode on page 27</i> .
Blue flashing light	The boundary wire is not connected to the charging station.	Make sure that the boundary wire is correctly installed in the charging station. Refer to <i>To install the boundary wire on page 20</i> .
	Damage in the boundary wire.	Find out where the damage is. Replace the damaged section with new boundary wire.
Yellow flashing light	The guide wire is not connected to the charging station.	Make sure that the guide wire is correctly installed in the charging station. Refer to <i>To install the guide wire on page 20</i> .
	Damage in the guide wire.	Find out where the damage is. Replace the damaged section with new guide wire.
Red flashing light	Interference in the antenna of the charging station.	Speak to your GARDENA service.
Red solid light	Error in the circuit board or incorrect power supply in the charging station. The error must be corrected by your GARDENA service	Speak to your GARDENA service.



6.5 Symptoms

If the product does not operate as usual, follow the symptoms table below. Speak to your GARDENA customer service if you cannot find the cause for the fault.

Symptoms	Cause	Action
The product has difficulty docking.	The guide wire is not put straight in a line and correct distance from the charging station.	Do a check of the installation of the charging station. Refer to <i>To install the charging station on page 19.</i>
	The guide wire is not put in the slot in the charging station plate.	Make sure that the guide wire is put straight in a line and put in the slot in the charging station plate. Refer to <i>To install the guide wire on page 20.</i>
	The charging station is not on a level surface.	Put the charging station on a level surface. Refer to <i>To examine where to put the charging station on page 14.</i>
The product operates at the wrong time.	The time or the date in the product is not correct.	Set the time or date. Refer to <i>To set the time & date on page 28.</i>
	The start and stop times for operating are incorrect.	Change the schedule settings. Refer to <i>To reset the schedule setting on page 24.</i>
The product vibrates.	The cutting system is not in balance because of damaged blades.	Examine the blades and screws and replace them if necessary. Refer to <i>Replace the blades on page 35.</i>
	The cutting system is not in balance because of too many blades in the same position.	Do a check that only one blade is attached to each screw.
	Different thickness of blades are installed on the product.	Do a check if the blades are of different thickness and replace if necessary.
The product operates, but the blade disc does not rotate.	The product searches for the charging station, or is moving to the starting point.	Usual operation for the product. The blade disc does not rotate when the product is searching for the charging station.
The product operates for shorter periods than usual between charges.	Grass or other object causes a blockage to the blade disc.	Remove and clean the blade disc. Refer to <i>Clean the product on page 34.</i>
	The battery is at the end of its life cycle.	Replace the battery. Refer to <i>Battery on page 36.</i>
	Blunt blades. More energy is necessary when cutting the grass.	Replace the blades. Refer to <i>Replace the blades on page 35.</i>
Mowing and charging times are shorter than usual.	The battery is at the end of its life cycle.	Replace the battery. Refer to <i>Battery on page 36.</i>



Symptoms	Cause	Action
The product is parked for hours in the charging station.	The product has operated the maximum cutting time for the day.	Usual operation for the product. Refer to <i>Make an estimate of the necessary operating time on page 24.</i>
	The STOP button has been pushed.	Open the hatch, enter the PIN code and push the OK button. Push the Start button and then close the hatch.
	Parking mode is enabled.	Change the operating mode. Refer to <i>Operating modes on page 31.</i>
	The product does not operate if the battery temperature is too high or too low.	Make sure that the charging station is put in an area with protection from the sun.
Uneven mowing results.	The product operates for a small number of hours per day.	Increase the cutting time. Refer to <i>To set the schedule on page 23.</i>
	For the shape of the work area it is necessary to adjust the settings for <i>Lawn Coverage</i> to cover all parts of the work area.	Change the settings of the areas where the product starts to cut and how often. Refer to <i>To set the Lawn Coverage function on page 26.</i>
	The work area is too large.	Decrease the size of the work area or extend the schedule. Refer to <i>To set the schedule on page 23.</i>
	Blunt blades.	Replace all the blades. Refer to <i>Replace the blades on page 35.</i>
	Long grass in relation to the set cutting height.	Increase the cutting height and then lower it when the grass is shorter.
	Collection of grass by the blade disc or around the motor shaft.	Remove the collection of grass and clean the product. Refer to <i>Clean the product on page 34.</i>
The battery state of charge is high, but the product goes back to the charging station.	To prevent to become blocked in a small area, the product follows the guide wire to the charging station.	Usual operation for the product.

6.6 Find breaks in the loop wire

Breaks in the loop wire are usually the result of unintentional physical damage to the wire such as when gardening with a shovel. In countries with ground frost, also sharp stones that move in the ground can damage the wire. Breaks can also occur due to the wire being stretched excessively during installation.

Mowing the grass too low right after the installation can damage wire insulation. Damage to the insulation may not cause disruptions until several weeks or months later. To avoid this, always select the maximum cutting height the first weeks after installation and then lower the height one step at a time every second week until the desired cutting height has been reached.

A defective splicing of the loop wire can also lead to disruptions several weeks after the splice was done. A faulty splice can, for example, be the result of the coupler not being pressed together hard enough with a

pair of pliers, or that a coupler of lower quality than the original coupler has been used. Please first check all known splices before further troubleshooting is done.

A wire break can be located by gradually halving the distance of the loop where the break may have occurred until there is only a very short section of the wire left.

The following method does not work if *ECO mode* is activated. Make sure first that *ECO mode* is switched off. Refer to *ECO mode on page 27.*

1. Check that the indicator lamp in the charging station flashes blue, which indicates a break in the boundary loop. Refer to *Indicator lamp in the charging station on page 44.*

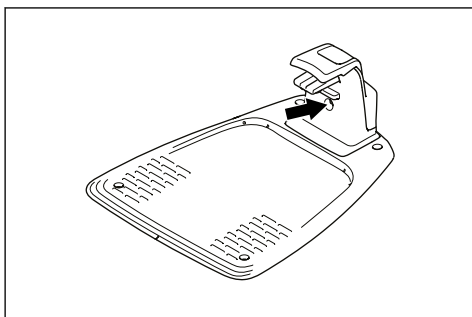

2. Check that the boundary wire connections to the charging station are properly connected and not damaged. Check that the indicator lamp in the charging station is still flashing blue.

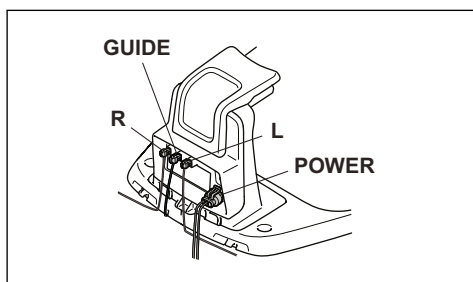

3. Switch the connections between the guide wire and the boundary wire in the charging station.
Start by switching connection L and GUIDE.
If the indicator lamp is flashing yellow, then the break is somewhere on the boundary wire between L and the point where the guide wire is connected to the boundary wire (thick black line in the illustration).

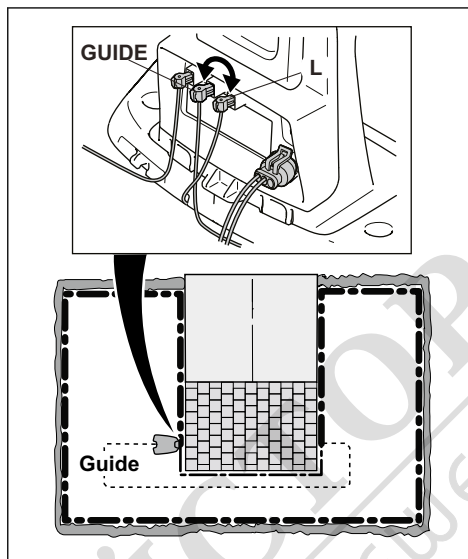

To rectify the fault you will need boundary wire, connector(s) and coupler(s):

- a) If the suspected boundary wire is short then the easiest way is to exchange all of the boundary wire between L and the point where the guide wire is connected to the boundary wire (thick black line).
- b) If the suspected boundary wire is long (thick black line) then do as follows: Put L and GUIDE back to their original positions. Then disconnect R. Connect a new loop wire to R. Connect the other end of this new loop wire at the middle of the suspected wire section.

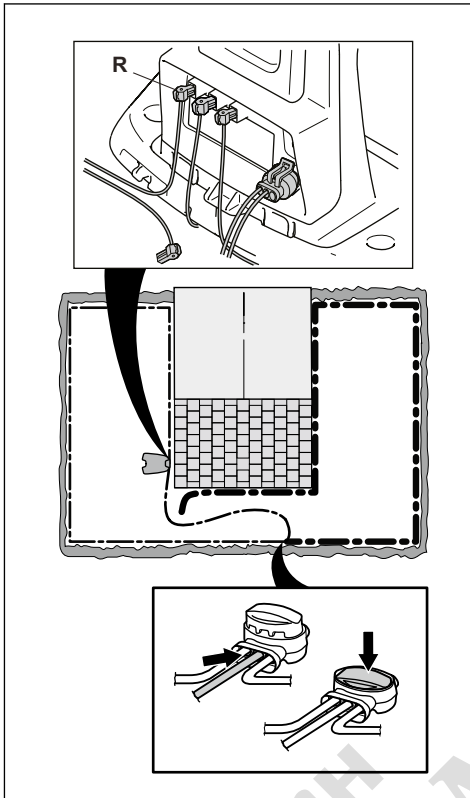

If the indicator lamp now is flashing yellow, then the break is somewhere in the wire between the disconnected end to the point where the new wire is connected (thick black line below). In that case, move the connection for the new wire closer to the disconnected end (roughly at the middle of the suspected wire section) and check again if the indicator lamp is green.

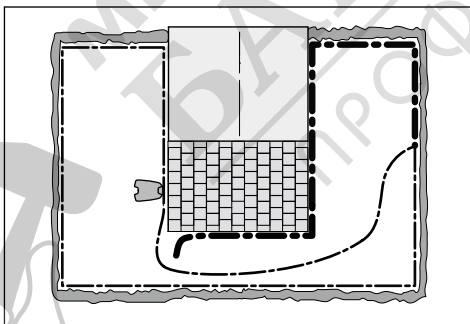

- Continue until only a very short section of the wire remains which is the difference between a solid green light and a flashing blue light. Then follow instruction in step 5 below.
4. If indicator lamp still flashes blue in step 3 above: Put L and GUIDE back in their original positions. Then switch R and GUIDE. If indicator lamp now is lit with a solid green light then disconnect L and connect a new boundary wire to L. Connect the other end of this new wire at the middle of the suspected wire section. Follow the same approach as in 3a) and 3b) above.
 5. When the break is found, the damaged section must be replaced with a new wire. Always use original couplers.

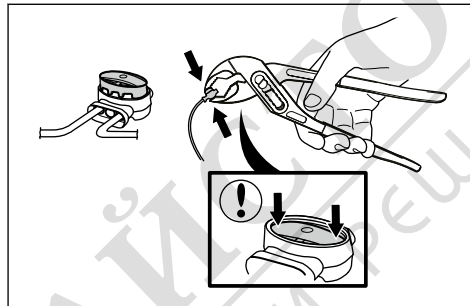

7 Transportation, storage and disposal

7.1 Transportation

The supplied Li-ion batteries obey the Dangerous Goods Legislation requirements.

- Obey all applicable national regulations.
- Obey the special requirement on package and labels for commercial transportations, including by third parties and forwarding agents.

7.2 Storage

- Fully charge the product. Refer to *To charge the battery on page 32*.
- Switch off the product. Refer to *To set the product to OFF on page 32*.
- Clean the product. Refer to *Clean the product on page 34*.
- Keep the product in a dry, frost free space.
- Keep the product with all wheels on level ground during storage.
- If you keep the charging station indoors, disconnect and remove the power supply and all the connectors from the charging station. Put the end of each connector wire in a connector protection box.

Note: If you keep the charging station outdoors, do not disconnect the power supply and the connectors.

- Speak to your GARDENA service for information about available storage accessories for your product.

7.3 Disposal

- Obey the local recycling requirements and applicable regulations.
- For questions about how to remove the battery, refer to *Battery on page 36*.



8 Technical data

8.1 Technical data

Data	SILENO city smart SILENO city	SILENO life smart SILENO life
Dimensions		
Length, cm / in.	55 / 21.7	58 / 22.8
Width, cm / in.	38 / 15.0	39 / 15.4
Height, cm / in.	23 / 9.1	23 / 9.1
Weight, kg / lb	7.3 / 16	8.3 / 18
Electrical system		
	SILENO city smart SILENO city	SILENO life smart SILENO life
Battery, Lithium-Ion 18.5 V/2.0 Ah Art.No	590 21 42-07	
Battery, Lithium-Ion 18 V/2.0 Ah Art.No	590 21 42-02, 590 21 42-04, 584 85 28-03, 584 85 28-05	
Battery, Lithium-Ion 18.25 V/2.0 Ah Art.No	590 21 42-03, 584 85 28-04, 590 21 42-06	
Battery, Lithium-Ion 18.5 V/2.5 Ah Art.No	590 21 42-08	
Power supply (28V DC), V AC	100-240	100-240
Low voltage cable length, m / ft.	5 / 16.4	5 / 16.4
Mean energy consumption at maximum use	4.5 kWh/month in a 600 m ² work area	8 kWh/month in a 1500 m ² work area
Charge current, A DC	1 / 1.3	1.3
Type of Power Supply Unit ²	ADP-40BR XX, ADP 28EW XX, FW7313/28/D/XX/Y/1.3/PI, FW7313/28/D/XX/Y/1.3, ADP 28AR XX, ADP-28AW XX, FW7313/28/D/XX/Y/1.0/PI, FW7313/28/D/XX/Y/1.0	
Average mowing time, min	65	65
Average charging time, min	75 / 60	60
Boundary wire antenna		
	SILENO city smart SILENO city	SILENO life smart SILENO life
Operating Frequency Band, Hz	100-80000	100-80000
Maximum magnetic field ³ , dBuA/m	82	82
Maximum Radio-frequency power ⁴ , mW @60m	<25	<25

² XX, YY can be any alphanumeric characters or blank for marketing purpose only, no technical differences.

³ Measured according to EN 303 447.

⁴ Maximum active output power to antennas in the frequency band in which the radio equipment operates.

Sound data⁵	SILENO city smart SILENO city	SILENO life smart SILENO life
Sound level, perceived, dB	57	57
Measured sound power noise level, dB (A)	56	56
Noise emissions uncertainties K_{WA} , dB (A)	2	2
Guaranteed sound power noise level, dB (A)	58	58
Sound pressure noise level at the operator's ear ⁶ , dB (A)	45	45

Mowing	SILENO city smart SILENO city	SILENO life smart SILENO life
Cutting system	3 pivoted cutting blades	
Cutting motor speed, rpm	2500	2500
Power consumption during cutting, W +/- 20 %	20	20
Cutting height, cm / in.	2-5 / 0.8-2	2-5 / 0.8-2
Cutting width, cm / in.	16 / 6.3	22 / 8.7
Narrowest possible passage, cm / in.	60 / 24	60 / 24
Maximum slope for cutting area, %	35	35
Maximum slope for boundary wire, %	10	10
Maximum length boundary wire, m / ft.	300 / 980	300 / 980
Maximum length guide loop ⁷ , m / ft.	150 / 490	150 / 490

IP-code	SILENO city smart SILENO city	SILENO life smart SILENO life
Product	IPX5	IPX5
Charging station	IPX5	IPX5
Power supply	IP44	IP44

Bluetooth®	SILENO city smart SILENO city	SILENO life smart SILENO life
Operating frequency band, MHz	2400 - 2484	2400 - 2484
Maximum transmitted power, dBm	8	8

⁵ Determined according to Directive 2006/42/EC and standard EN 50636-2-107. Except Sound level, perceived that is measured according to ISO 11094:1991.

⁶ Sound pressure noise uncertainties K_{pA} , 2-4 dB (A)

⁷ The guide loop is the loop that if formed by the guide wire and the part of the boundary wire from the junction with the guide wire to the right connection in the charging station.

Internal SRD (short range device)	SILENO city, SILENO life	smart SILENO city, smart SILENO life
Operating frequency band, MHz	-	863-870
Maximum transmitted power, dBm	-	14
Free field radio range, approx. m	-	100

Husqvarna AB does not guarantee full compatibility between the product and other types of wireless systems such as remote controls, radio transmitters, hearing loops, underground electric animal fencing or similar.

The products are made in England or the Czech Republic. See information on the rating plate. Refer to *Introduction on page 3*.



МАГАЗИН
БАШ МАЙСТОРА
ПРОФЕСИОНАЛНИ РЕШЕНИЯ

9 Warranty

9.1 Warranty terms

GARDENA warranty covers this product's functionality for a period of 2 years from date of purchase. The warranty covers serious faults relating to materials or manufacturing faults. Within the warranty period, we will replace the product or repair it at no charge if the following terms are met:

- The product and the charging station may only be used in compliance with the instructions in this Operator's Manual. This manufacturer's warranty does not affect warranty entitlements against the dealer/retailer.
- End-users or non-authorized third parties must not attempt to repair the product.

Examples of faults which are not included in the warranty:

- Damage caused by water seepage from using a high-pressure washer, or from being submerged under water, for example when heavy rain forms pools of water.
- Damage caused by lightning.
- Damage caused by improper battery storage or battery handling.
- Damage caused by using a battery that is not a GARDENA original battery.
- Damage caused by not using GARDENA original spare parts and accessories, such as blades and installation material.
- Damage to the loop wire.
- Damage caused by non-authorized changing or tampering with the product or its power supply.

The blades and wheels are seen as disposable and are not covered by the warranty.

If an error occurs with your GARDENA product, please contact GARDENA customer service for further instructions. Please have the receipt and the product's serial number at hand when contacting GARDENA customer service.

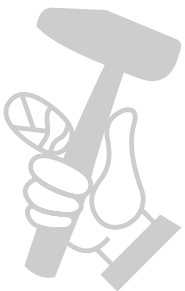

10 EU Declaration of Conformity

We, Husqvarna AB, SE 561 82 Huskvarna, SWEDEN,
Tel. +46 36 146500 declare on our sole responsibility
that the product:

Description	Robotic lawn mower
Brand	HUSQVARNA
Type/Model	GARDENA SILENO city, smart SILENO city, SILENO life, smart SILENO life
Identification	Serial numbers dating from 2021 week 31

complies fully with the following EU directives and regulations:

Regulation	Description
2006/42/EC	Relating to machinery
2014/53/EU	Relating to radio equipment
2011/65/EU	Restriction of use of certain hazardous substances

and that the following harmonized standards and/or technical specifications are applied;

- EN 60335-1:2012+AC:2014+A11:2014+A13:2017
- EN 50636-2-107:2015+A1:2018+A2:2020
- EN IEC 63000:2018
- EN 61000-6-1:2007
- EN 61000-6-3:2007+A1:2011+AC:2012
- ETSI EN 301 489-1 V2.2.3
- ETSI EN 301 489-3 V2.1.1
- ETSI EN 301 489-17 V3.1.1
- Draft ETSI EN 303 447 V1.2.1_0.1.16
- ETSI EN 300 328 V2.2.2

and for and :

- ETSI EN 301 489-19 V2.1.1
- ETSI EN 300 220-1 V3.1.1
- ETSI EN 300 220-2 V3.1.1
- ETSI EN 303 413 V1.1.1

The notified body RISE Research Institutes of Sweden AB, No. 0402, has issued a type examination certificate with no. C900196 covering Art. 3.2 of 2014/53/EU.



11 UK Declaration of Conformity

We, Husqvarna AB, SE 561 82 Huskvarna, SWEDEN,
Tel. +46 36 146500 declare on our sole responsibility
that the product:

Description	Robotic lawn mower
Brand	HUSQVARNA
Type/Model	GARDENA SILENO city, smart SILENO city, SILENO life, smart SILENO life
Identification	Serial numbers dating from 2021 week 31

complies fully with the following UK directives and regulations:

Regulation	Description
S.I. 2008/1597	The Supply of Machinery (Safety) Regulations 2008
S.I. 2017/1206	The Radio Equipment Regulations 2017
S.I. 2012/3032	The Restriction of the Use of Certain Hazardous Substances in Electrical and Electronic Equipment Regulations 2012

and that the following harmonized standards and/or technical specifications are applied;

- EN 60335-1:2012+AC:2014+A11:2014+A13:2017
- EN 50636-2-107:2015+A1:2018+A2:2020
- EN IEC 63000:2018
- EN 61000-6-1:2007
- EN 61000-6-3:2007+A1:2011+AC:2012
- ETSI EN 301 489-1 V2.2.3
- ETSI EN 301 489-3 V2.1.1
- ETSI EN 301 489-17 V3.1.1
- Draft ETSI EN 303 447 V1.2.1_0.1.16
- ETSI EN 300 328 V2.2.2

and for and :

- ETSI EN 301 489-19 V2.1.1
- ETSI EN 300 220-1 V3.1.1
- ETSI EN 300 220-2 V3.1.1
- ETSI EN 303 413 V1.1.1

**UK
CA**

UK Importer:
Husqvarna UK Ltd
Preston Road, Co. Durham
DL5 6UP



ORIGINAL INSTRUCTIONS

We reserve the right to make changes without prior notice.
Copyright © 2021 GARDENA Manufacturing GmbH. All rights reserved.

1142751-26



2021-08-23