

Denominazione:

ASSIEME CONVERTITORE 1 K MONOFASE ST ST0488



LAE SRL

Data: **15/01/08**

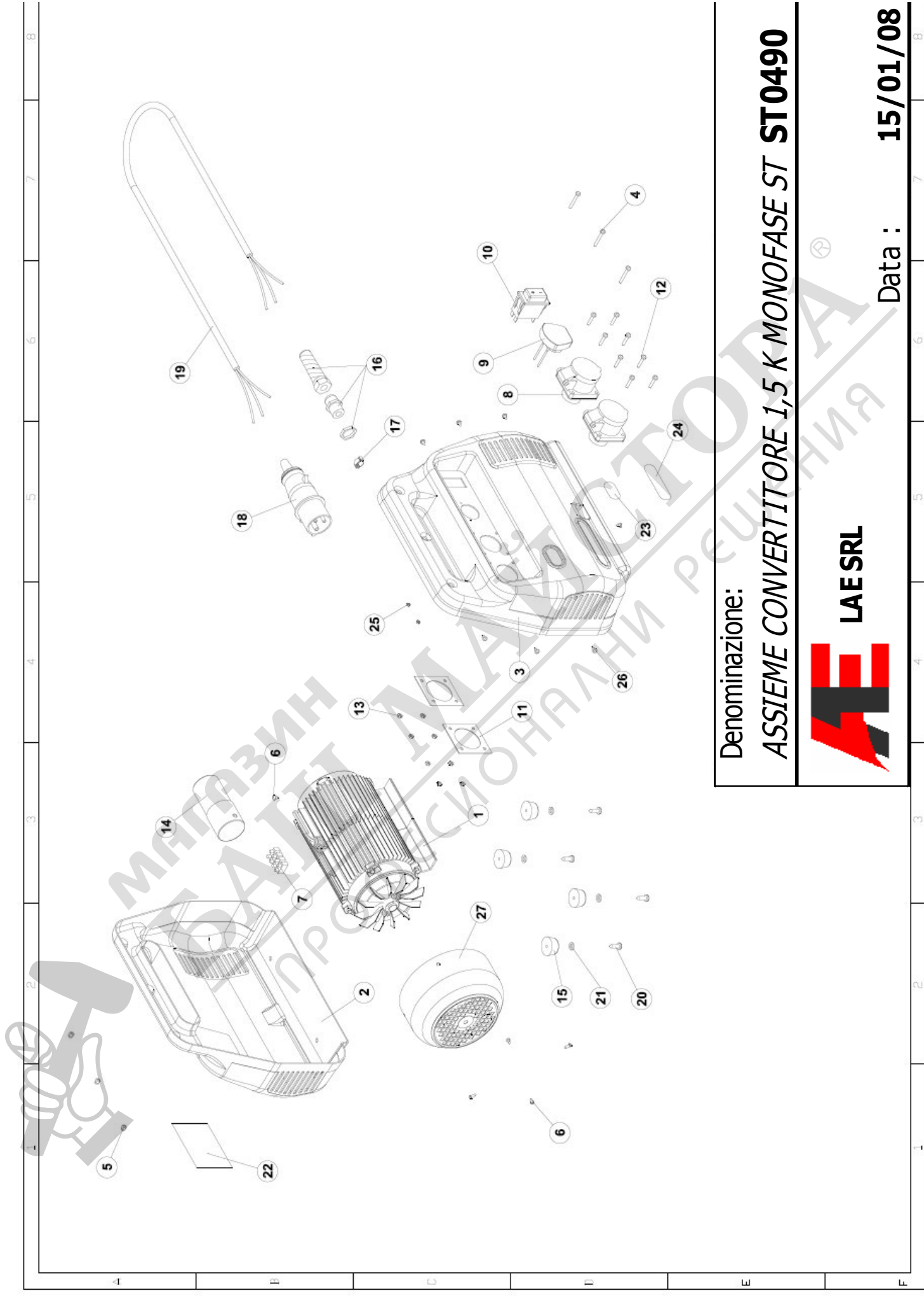

Denominazione:

ASSIEME CONVERTITORE 1,5 K MONOFASE ST ST0490



Data : **15/01/08**

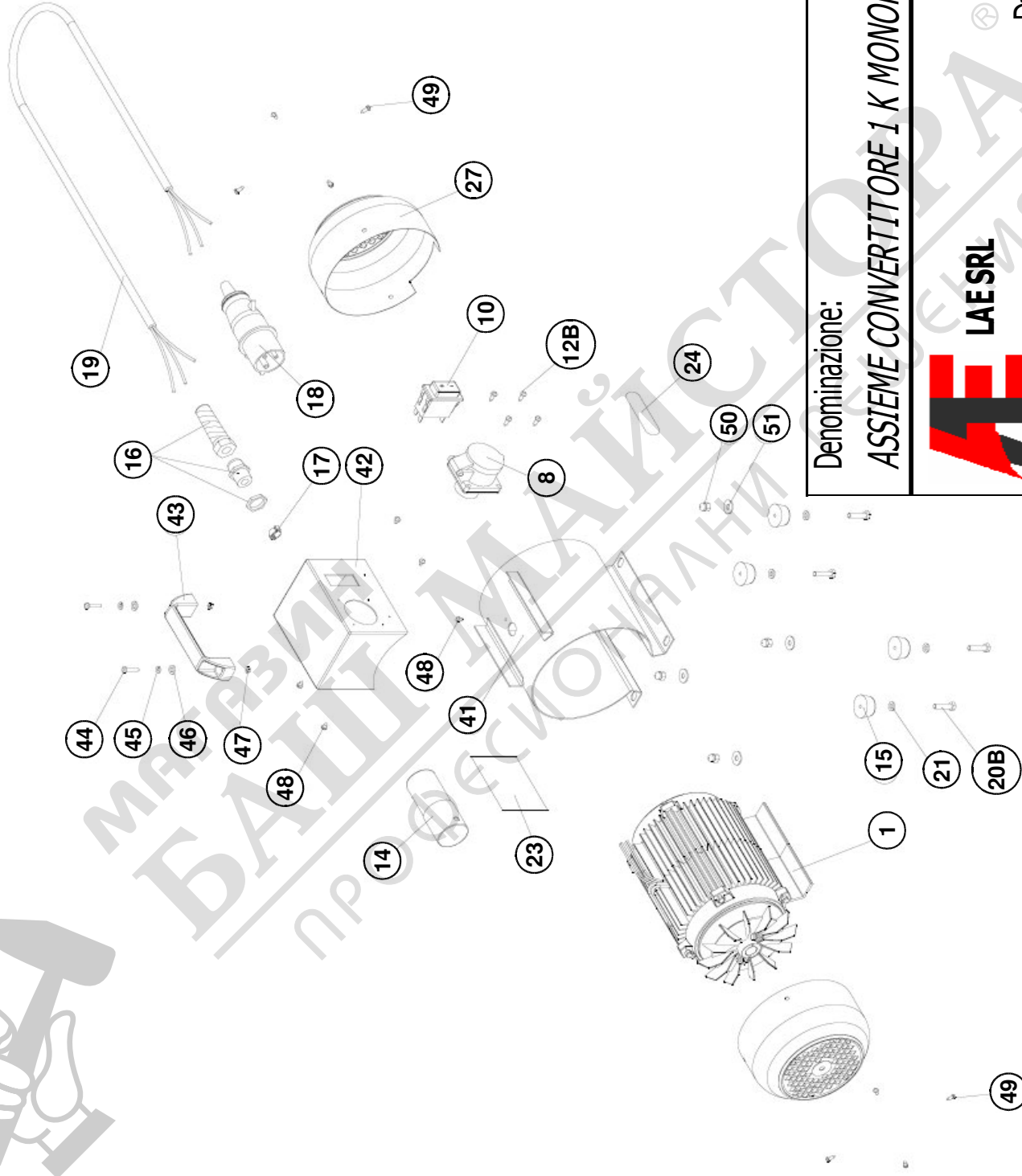
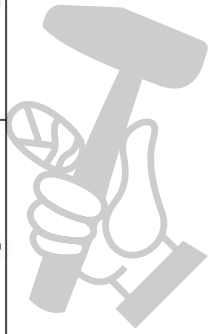

Denominazione:

ASSIEME CONVERTITORE 1 K MONOFASE NW NW0588



Data : **18/03/09**

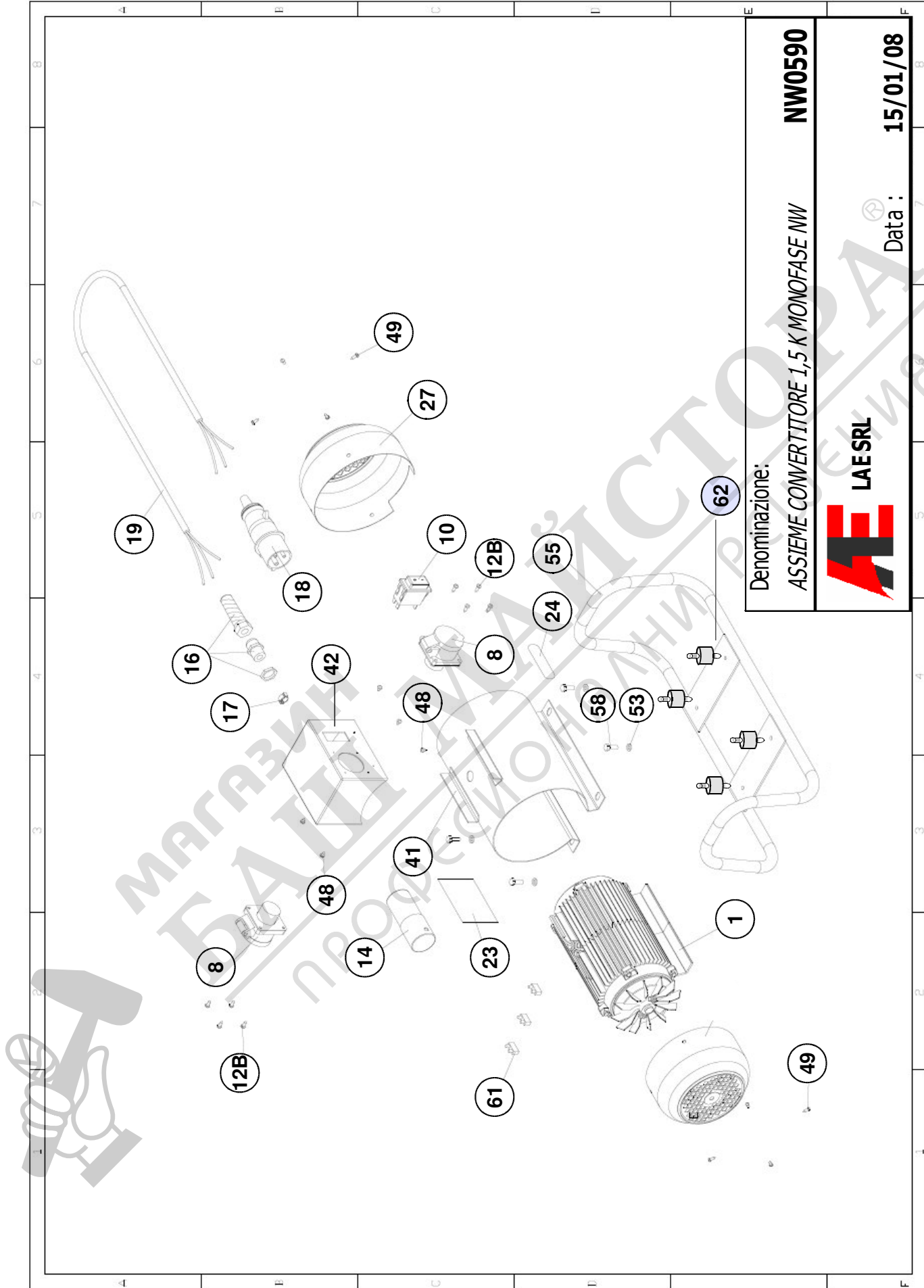

Denominazione: **NW0590**
ASSEMBLEO CONVERTITTORE 1,5 K MONOFASE NW

LAESRL
Data : **15/01/08**



Listino ricambi **CONVERTITORE - ST/NW** – 2014
Spare parts price list for **HF CONVERTER - ST/NW** – 2014

Pos.	cod.	descrizione	description
1	ST001	Assieme alternatore-motore CONV. ST 1K M	Motor and stator assembly
2	ST002	carcassa ABS retro ST	ABS plastic housing front ST
3	ST003	carcassa ABS fronte ST	ABS plastic housing back ST
4	ST004	vite M4x20	screw M4x20
5	ST005	dado M4 cieco per carcassa	blind nut M5 for housing
6	ST006	vite autofilettante D. 3,9x6,5	screw
7	ST007	morsettiera 4P	terminal 4P
8	ST008	presa 42V - 200 Hz - 625 verde	socket 42V - 200 Hz
10	ST034A	Interruttore monofase termico 7A	singlephase thermic switch 7A
	ST034B	Interruttore monofase termico 16A	singlephase thermic switch 16A
	ST034D	Interruttore trifase termico 5A	threephase thermic switch 5A
	ST034E	Interruttore trifase termico 8A	threephase thermic switch 8A
	ST034F	SALVAMOTORE per 5K/6-10A completo	OVERLOAD CUTOUT complete 5K/6-10A
11	ST011	mascherina in lamiera per presa	cover sheet for socket
12	ST012	vite M4x35 per presa	screw M4x35 for socket
12B	NW012B	vite M3,9X16 per presa x NW	screw M.3,9x16 for socket NW
13	ST013	dado M4 per mascherina in lamiera	nut M4 for cover sheet
14	ST014	condensatore	condenser
15	ST015	pieidino in gomma + vite	rubber pin plus screw
16	ST016	pressacavo skintop PG13,5	skintop
17	ST017	pressacavo in ferro 10-12 / 2 orecchie	skintop 10-12 / 2 ears
18	ST018	spina 220V - 50Hz 16A monofase 2P+T	plug 220V-50Hz-16A-singlephase 2P+T
	ST018B	spina 380V - 50Hz 16A trifase 3P+T	plug 380V-50Hz-16A-threephase 2P+T
19	ST019	cavo alimentazione 1,6mt	power cable
20	ST020	vite autof. D. 5,5x25 per piedini x ST	screw d. 5,5x25 for rubber pin for ST
20B	NW020B	vite autof. D. 6x25 per piedini x NW	screw M.6x25 for pin for NW
21	ST021	rondella int.6 per piedini	washer for rubber foot
26	ST026	vite autof. D. 3,5x9,5 per carcassa st	screw D. 3,5x9,5 for housing ST
27	ST027	copriventola	cover-fan
28	ST028	ventola + fascetta	fan + clamp
29	ST029	calotta aperta (scudo)	open cover
30	ST030	calotta chiusa (scudo)	close cover
31	ST031	dado + rondella	nut + washer
32	ST032	cuscinetto D. 52X24X15 - 6205zz	bearing D. 52x24x15 - 6205zz
33	ST033	tirante filettato L=198	threaded screw

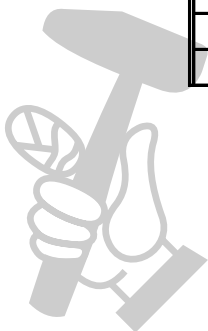



Listino ricambi **CONVERTITORE - ST/NW** – 2014
Spare parts price list for **HF CONVERTER - ST/NW** – 2014

Pos.	cod.	descrizione	description
34	ST034	alternatore convert.	alternator
35	ST035	statore motore convertitore	motor - stator
36	ST036	rotore completo (37-38-39)	complete rotor (37+38+39)
37	ST037	rotore magnetico	magnetic rotor
38	ST038	albero	shaft
39	ST039	rotore pressofuso	cast rotor
40	ST040	anello compensazione	compensation ring
41+42	NW000	Carcassa metallo con scatola vuota (41+42)	housing metallic with empty box (41+42)
43	NW043	Maniglia	handle
44	NW044	vite 4x20	screw 4x20
45	NW045	rondella D5	washer D5
46	NW046	rondella D6	washer D6
47	NW047	dado M4	nut M4
48	NW048	vite 3,9x9,5	screw 3,9x9,5
49	NW049	vite 3,9x6,5	screw 3,5x6,5
50	NW050	dado M6	nut M6
51	NW051	rondella M6	washer M.6
52	NW052	vite	screw
53	NW053	rondella	washer
54	NW054	rondella	washer
55	NW055	slitta	sledge
56	NW056	rondella M5	washer M.5
57	NW057	dado cieco	blind nut
58	NW058	protezione interruttore	switch protection
59	NW059	vite per protezione interruttore	screw for switch protection
60	NW060	morsetto volante	flying terminal
61	NW061	morsettiera 3P	3 pins terminal
62	NW062	antivibrante per slitta 30x20B	silent block 30x20B

ST038 1 M	Carcassa completa fronte/retro 1Kva mono piedini+viti, presa, spina, interruttore mono, cavo alimentazione, pressacavo
ST040 1 TT	Carcassa completa fronte/retro 1Kva tri term. piedini+viti, presa, spina, interruttore tri, cavo alimentazione, pressacavo
ST043 1,5 M	Carcassa completa fronte/retro 1,5Kva mono piedini+viti, 2prese, spina, interruttore mono, cavo alimentazione, pressacavo
ST041 2 TT	Carcassa completa fronte/retro 2Kva tri term. piedini+viti, 2 prese, spina, interruttore tri, cavo alimentazione, pressacavo

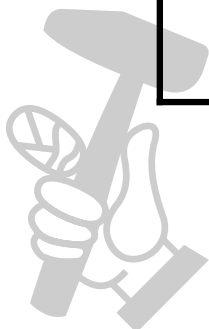



Ricambi CONVERTITORE - ST/NW

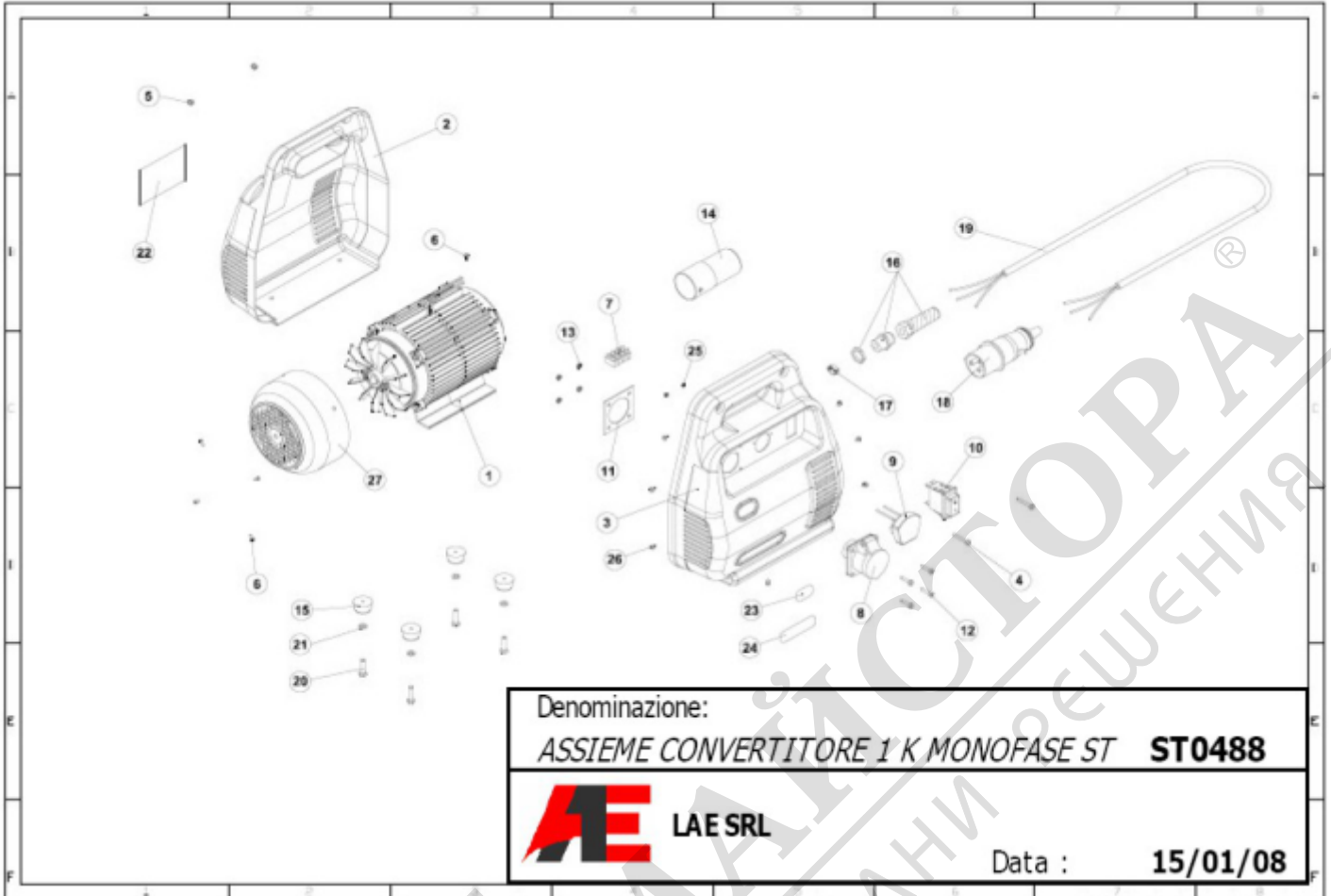

Denominazione:

ASSEMBLE CONVERTITORE 1 K MONOFASE ST **ST0488**



LAE SRL

Data :

15/01/08

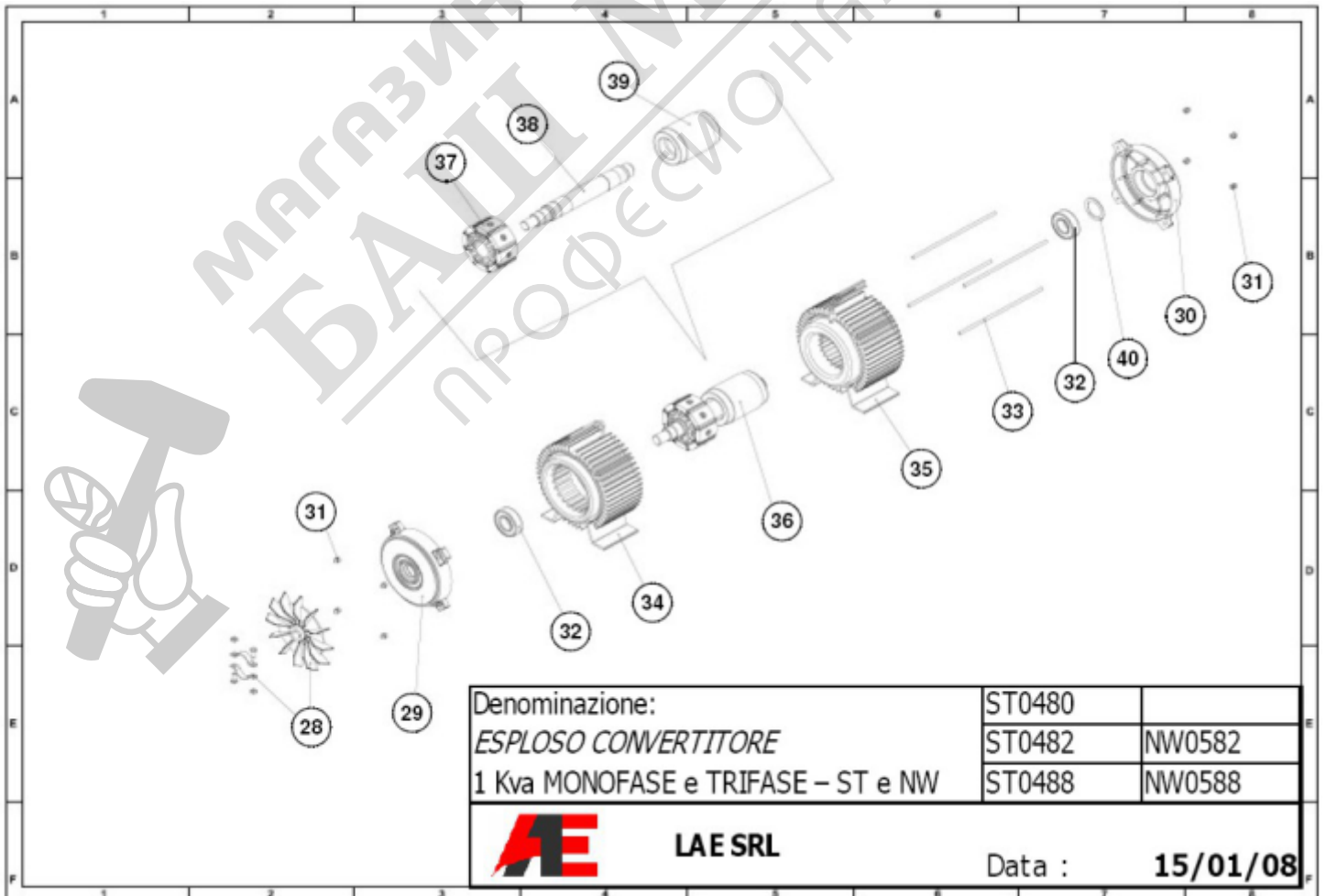

Denominazione:

ESPLOSO CONVERTITORE

1 Kva MONOFASE e TRIFASE - ST e NW

ST0480

ST0482

ST0488

NW0582

NW0588



LAE SRL

Data :

15/01/08