

Husqvarna, 2018-03-12

## Safety and Operating Instructions

Dear customer,

thank you for choosing a Husqvarna quality product. We hope that you will genuinely enjoy it.  
Please note that the enclosed manual contains Atlas Copco references.

The Husqvarna Group is vouching for the quality of this product.

If you have any questions, please do not hesitate to contact our local sales or service point.

Husqvarna AB  
561 82 Huskvarna, Sweden

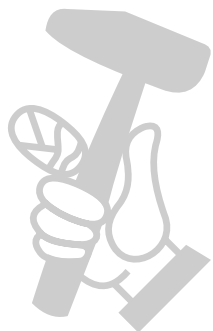

МАГАЗИН МАЙСТОРА  
БАШ МАЙСТОРА  
ПРОФЕСИОНАЛНИ РЕШЕНИЯ

## Safety and operating instructions

### Poker Vibrators with flexible shaft

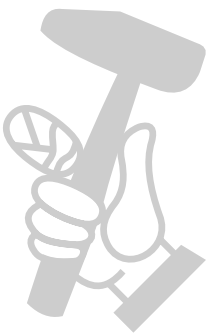
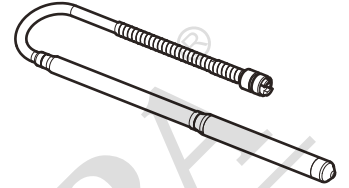

МАГАЗИН  
БАШ МАЙСТОР  
ПРОФЕСИОНАЛНИ РЕШЕНИЯ

# Contents

Introduction.....	5
About the Safety and operating instructions.....	5
Safety instructions.....	6
<b>Safety signal words</b> .....	6
<b>Work area</b> .....	6
<b>Personal safety</b> .....	6
Personal protective equipment.....	6
Drugs, alcohol or medication.....	6
<b>Operating, precautions</b> .....	7
<b>Maintenance, precautions</b> .....	9
<b>Storage</b> .....	9
Overview.....	10
<b>Design and function</b> .....	10
<b>Main parts</b> .....	10
Vibrator head AA.....	10
Operation.....	10
<b>Preparations before vibrating</b> .....	10
Starting.....	10
Vibrating.....	10
When taking a break.....	11
Maintenance.....	11
<b>Disassembly</b> .....	11
<b>Assembly</b> .....	11
Storage.....	11
Disposal.....	11
Technical data.....	13
<b>Tool data AA</b> .....	13



## Introduction

Thank you for choosing a product from Atlas Copco. Since 1873, we have been committed to finding new and better ways of fulfilling our customers' needs. Through the years, we have developed innovative and ergonomic product designs that have helped customers improve and rationalize their daily work.

Atlas Copco has a strong global sales and service network, consisting of customer centers and distributors worldwide. Our experts are highly trained professionals with extensive product knowledge and application experience. In all corners of the world, we can offer product support and expertise to ensure that our customers can work at maximum efficiency at all times.

For more information please visit: [www.atlascopco.com](http://www.atlascopco.com)

Atlas Copco Construction Tools AB

Box 703

391 27 Kalmar

Sweden

## About the Safety and operating instructions

The aim of the instructions is to provide you with knowledge of how to use the machine in an efficient, safe way. The instructions also give you advice and tell you how to perform regular maintenance on the machine.

Before using the machine for the first time you must read these instructions carefully and understand all of them.

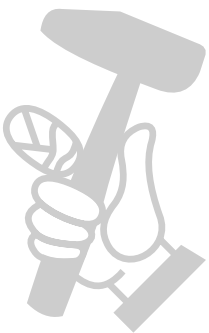

## Safety instructions

To reduce the risk of serious injury or death to yourself or others, read and understand the Safety and operating instruction before installing, operating, repairing, maintaining, or changing accessories on the machine.

Post this Safety and operating instruction at work locations, provide copies to employees, and make sure that everyone reads the Safety and operating instruction before operating or servicing the machine.

In addition, the operator or the operator's employer must assess the specific risks that may be present as a result of each use of the machine.

Save all warnings and instructions for future reference.

## Safety signal words

The safety signal words Danger, Warning and Caution have the following meanings:

<b>DANGER</b>	Indicates a hazardous situation which, if not avoided, will result in death or serious injury.
<b>WARNING</b>	Indicates a hazardous situation which, if not avoided, could result in death or serious injury.
<b>CAUTION</b>	Indicates a hazardous situation which, if not avoided, could result in minor or moderate injury.

## Work area

### ▲ WARNING Secure the working area

Cluttered benches and insufficient lighting can cause personal accidents and result in serious injuries.

- ▶ Keep the working area clean.
- ▶ Maintain adequate lighting in the working area.

Only qualified and trained persons may operate or maintain the machine. They must be physically able to handle the bulk, weight, and power of the machine. Always use your common sense and good judgement.

Keep bystanders, children, and visitors away while operating the machine. Distractions may cause loss of control.

## Personal safety

### Personal protective equipment

Always use approved protective equipment.

Operators and all other persons in the working area must wear protective equipment, including at a minimum:

- Protective helmet
- Hearing protection
- Impact resistant eye protection with side protection
- Respiratory protection when appropriate
- Protective gloves
- Proper protective boots
- Appropriate work overall or similar clothing (not loose-fitting) that covers your arms and legs.

### Drugs, alcohol or medication

#### ▲ WARNING Drugs, alcohol or medication

Drugs, alcohol or medication may impair your judgment and powers of concentration. Poor reactions and incorrect assessments can lead to severe accidents or death.

- ▶ Never use the machine when you are tired or under the influence of drugs, alcohol or medication.
- ▶ No person who is under the influence of drugs, alcohol or medication may operate the machine.

#### ▲ WARNING Slipping, tripping and falling hazards

There is a risk of slipping or tripping or falling, for example tripping on the hoses or on other objects. Slipping or tripping or falling can cause injury. To reduce this risk:

- ▶ Always make sure that no hose or other object is in your way or in any other person's way.
- ▶ Always make sure you are in a stable position with your feet as far apart as your shoulders width and keeping a balanced body weight.

**▲ WARNING Dust and fume hazard**

Dusts and/or fumes generated or dispersed when using the machine may cause serious and permanent respiratory disease, illness, or other bodily injury (for example, silicosis or other irreversible lung disease that can be fatal, cancer, birth defects, and/or skin inflammation).

Some dusts and fumes created by compaction work contain substances known to the State of California and other authorities to cause respiratory disease, cancer, birth defects, or other reproductive harm.

Some examples of such substances are:

- Crystalline silica, cement, and other masonry products.
- Arsenic and chromium from chemically-treated rubber.
- Lead from lead-based paints.

Dust and fumes in the air can be invisible to the naked eye, so do not rely on eye sight to determine if there is dust or fumes in the air.

To reduce the risk of exposure to dust and fumes, do all of the following:

- ▶ Perform site-specific risk assessment. The risk assessment must include dust and fumes created by the use of the machine and the potential for disturbing existing dust.
- ▶ Use proper engineering controls to minimize the amount of dust and fumes in the air and to minimize build-up on equipment, surfaces, clothing, and body parts. Examples of controls include: exhaust ventilation and dust collection systems, water sprays, and wet drilling. Control dusts and fumes at the source where possible. Make sure that controls are properly installed, maintained and correctly used.
- ▶ Wear, maintain and correctly use respiratory protection as instructed by your employer and as required by occupational health and safety regulations. The respiratory protection must be effective for the type of substance at issue (and if applicable, approved by relevant governmental authority).
- ▶ Work in a well ventilated area.
- ▶ If the machine has an exhaust, direct the exhaust so as to reduce disturbance of dust in a dust filled environment.
- ▶ Operate and maintain the machine as recommended in the operating and safety instructions
- ▶ Wear washable or disposable protective clothes at the worksite, and shower and change into clean clothes before leaving the worksite to reduce exposure of dust and fumes to yourself, other persons, cars, homes, and other areas.

- ▶ Avoid eating, drinking, and using tobacco products in areas where there is dust or fumes.
- ▶ Wash your hands and face thoroughly as soon as possible upon leaving the exposure area, and always before eating, drinking, using tobacco products, or making contact with other persons.
- ▶ Comply with all applicable laws and regulations, including occupational health and safety regulations.
- ▶ Participate in air monitoring, medical examination programs, and health and safety training programs provided by your employer or trade organizations and in accordance with occupational health and safety regulations and recommendations. Consult with physicians experienced in relevant occupational medicine.
- ▶ Work with your employer and trade organization to reduce dust and fume exposure at the worksite and to reduce the risks. Effective health and safety programs, policies and procedures for protecting workers and others against harmful exposure to dust and fumes must be established and implemented based on advice from health and safety experts. Consult with experts.

## Operating, precautions

---

**▲ WARNING Incorrect usage**

An incorrect use of the machine, accessories, and insertion tools can result in serious injuries or a hazardous situation.

- ▶ Use the machine, accessories and tools in accordance with the safety instructions.
- ▶ Use the machine for what it is designed for, and in the way it is intended.
- ▶ Use the correct machine for the work that is going to be performed.
- ▶ Do not force the machine while operating.
- ▶ Take the working conditions into account.

**▲ WARNING Projectiles**

Failure of the work piece, of accessories, or even of the machine itself may generate high velocity projectiles. During operating, splinters or other particles from the compacted material may become projectiles and cause personal injury by striking the operator or other persons. To reduce these risk:

- ▶ Use approved personal protective equipment and safety helmet, including impact resistant eye protection with side protection.
- ▶ Make sure that no unauthorised persons trespass into the working zone.
- ▶ Keep the workplace free from foreign objects.

**▲ WARNING Unexpected movements**

The machine is exposed to heavy strains during operation. If the machine breaks or gets stuck, there may be sudden and unexpected movement that can cause injuries.

- ▶ Always inspect the machine prior to use. Never use the machine if you suspect that it is damaged.
- ▶ Make sure that the handle is clean and free of grease and oil.
- ▶ Keep your feet away from the machine.
- ▶ Never sit on the machine.
- ▶ Never strike or abuse the machine.
- ▶ Pay attention and look at what you are doing.

**▲ WARNING Vibration hazards**

Normal and proper use of the machine exposes the operator to vibration. Regular and frequent exposure to vibration may cause, contribute to, or aggravate injury or disorders to the operator's fingers, hands, wrists, arms, shoulders and/or nerves and blood supply or other body parts, including debilitating and/or permanent injuries or disorders that may develop gradually over periods of weeks, months, or years. Such injuries or disorders may include damage to the blood circulatory system, damage to the nervous system, damage to joints, and possibly damage to other body structures.

If numbness, persistent recurring discomfort, burning sensation, stiffness, throbbing, tingling, pain, clumsiness, weakened grip, whitening of the skin, or other symptoms occur at any time, when operating the machine or when not operating the machine, stop operating the machine, tell your employer and seek medical attention. Continued use of the machine after the occurrence of any such symptom may increase the risk of symptoms becoming more severe and/or permanent.

Operate and maintain the machine as recommended in these instructions, to prevent an unnecessary increase in vibration.

The following may help to reduce exposure to vibration for the operator:

- ▶ If the machine has vibration absorbing handles, keep them in a central position, avoid pressing the handles into the end stops.
- ▶ When the percussion mechanism is activated, the only body contact with the machine you must have are your hands on the handle or handles. Avoid any other contact, for example supporting any part of the body against the machine or leaning onto the machine trying to increase the feed force.
- ▶ Make sure that the machine is well-maintained and not worn out.
- ▶ Immediately stop working if the machine suddenly starts to vibrate strongly. Before resuming the work, find and remove the cause of the increased vibrations.
- ▶ Participate in health surveillance or monitoring, medical exams and training programs offered by your employer and when required by law.
- ▶ When working in cold conditions wear warm clothing and keep hands warm and dry.

See the "Noise and vibration declaration statement" for the machine, including the declared vibration values. This information can be found at the end of these Safety and operating instructions.

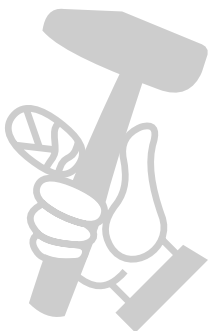

**▲ WARNING Noise hazard**

High noise levels can cause permanent and disabling hearing loss and other problems such as tinnitus (ringing, buzzing, whistling, or humming in the ears). To reduce risks and prevent an unnecessary increase in noise levels:

- ▶ Risk assessment of these hazards and implementation of appropriate controls is essential.
- ▶ Operate and maintain the machine as recommended in these instructions.
- ▶ If the machine has a silencer, check that it is in place and in good working condition.
- ▶ Always use hearing protection.

**▲ WARNING Accessory hazards**

Accidental engagement of accessories during maintenance or installation can cause serious injuries, when the power source is connected.

- ▶ Never inspect, clean, install, or remove accessories while the power source is connected.

## Maintenance, precautions

---

**▲ WARNING Machine modification**

Any machine modification may result in bodily injuries to yourself or others.

- ▶ Never modify the machine. Modified machines are not covered by warranty or product liability.
- ▶ Always use original parts and accessories approved by Atlas Copco.
- ▶ Change damaged parts immediately.
- ▶ Replace worn components in good time.

**▲ WARNING Damaged machine parts**

Lack of maintenance will result in damaged or worn parts that can cause accidents.

- ▶ Check the moving parts for misalignment or binding.
- ▶ Check the machine for broken or, in other ways, damaged parts.

Damaged or worn parts can effect the operation of the machine.

## Storage

---

- ◆ Keep the machine in a safe place, out of the reach of children and locked up.



## Overview

To reduce the risk of serious injury or death to yourself or others, read the Safety instructions section found on the previous pages of this manual before operating the machine.

## Design and function

AA poker vibrator is a high frequency concrete poker. The AA poker is designed according to the pendulum principle with low rotation speed in the shaft and with a high frequency in the vibrator tube.

The AA poker suits all types of construction sites. It fits on electric, gasoline and diesel driven units. The AA poker has a 6 meter (19.7 ft.) long flexible shaft.

## Main parts

### Vibrator head AA

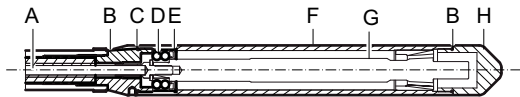

- A. Flexible shaft
- B. End shank
- C. O-ring
- D. Self-aligning ball bearing
- E. Sealing sleeves
- F. Tube
- G. Vibrator shaft
- H. End cap

## Operation

### Preparations before vibrating

#### Starting

1. Move the locking lever on the coupling forward.
2. Insert the coupling on the poker vibrator into the guiding sleeve of the drive unit.
3. Slightly rotate the motor coupling until the square fitting of the flexible shaft fits the square tube on the unit.

4. Release the locking lever. If the connection between the shaft and the drive unit is correct, the lever will return to the original position.

**NOTICE** Never connect the poker vibrator to a running drive unit.

When starting the vibrator it may require a sideway bump to the poker vibrator in order to start the vibration. Make sure that the hose does not bend to sharply or that any loops form. This will increase the wear and reduce the life time of the hose.

#### Vibrating

**NOTICE** Never use the poker vibrator to move the concrete sideways.

1. Allow the vibrator to penetrate about 15 cm (6 in.) down into the nearest lower layer to ensure that the various layers merge well with each other.
2. Fill the concrete evenly in the form work in 30 - 50 cm (12 - 19 in.) layers.

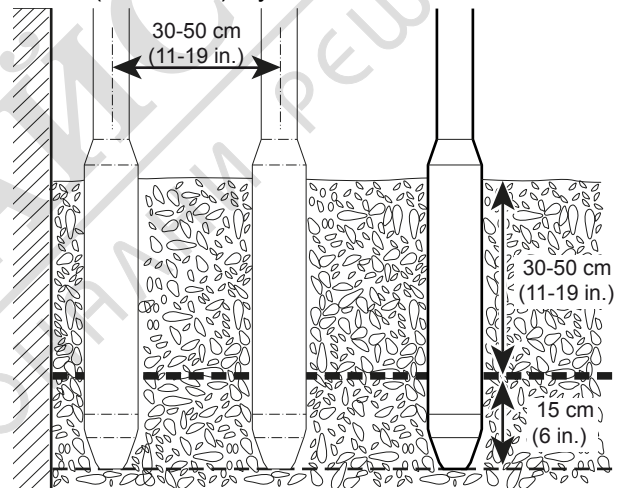

3. Insert the poker vibrator vertically at a distance of 8-10 times the tube diameter between insertions.
4. Vibrate systematically.
5. Slowly withdraw the vibrator to allow the concrete to refill the cavity left by the vibrator.

6. The concrete is thoroughly vibrated when the area around the vibrator turns shiny and no air bubbles rise to the surface. This will normally take about 10-20 seconds.

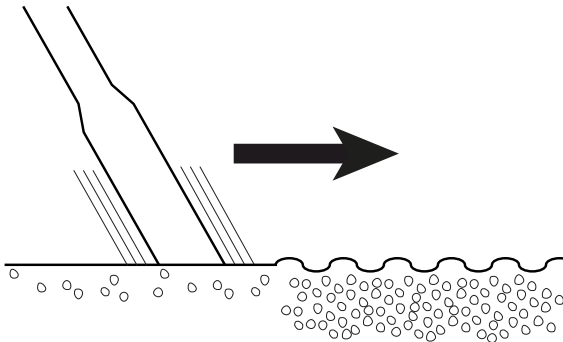

### When taking a break

- ◆ Stop the machine during breaks.
- ◆ Unplug the machine from the wall socket so that there is no risk for unintentional start.

## Maintenance

Regular maintenance is a basic requirement for the continued safe and efficient use of the machine. Follow the maintenance instructions carefully.

- ◆ Before starting maintenance on the machine, clean it in order to avoid exposure to hazardous substances. See "Dust and fume hazards"
- ◆ Use only authorised parts. Any damage or malfunction caused by the use of unauthorised parts is not covered by warranty or product liability.
- ◆ When cleaning mechanical parts with solvent, comply with appropriate health and safety regulations and ensure there is satisfactory ventilation.
- ◆ For major service of the machine, contact the nearest authorised workshop.
- ◆ After each service, check that the machine's vibration level is normal. If not, contact the nearest authorised workshop.

**NOTICE** Never lubricate internal parts of the poker. After every 500 hours of operation, dismantle the poker vibrator and check the components. Replace the O-rings, sealing sleeves and bearings.

The flexible shaft must be greased every 500 hours of operation.

## Disassembly

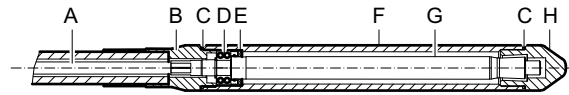

1. Place the poker in a tube vice.
2. Unscrew the end cap (H) and the end shank (B) (left hand thread).
3. Unscrew the flexible shaft (A) from the vibrator shaft (G) (right hand thread)
4. Use pliers at the end of the vibrator shaft and on the flexible shaft.
5. Remove the vibration shaft from the front of the tube.
6. If necessary remove the ball bearing (D) and the sealing sleeve (E).

## Assembly

1. Replace the O-rings, sealing sleeves and bearings each time the poker has been repaired.
2. Clean and grease the flexible shaft. See section "Lubrication".
3. Assemble the poker vibrator in reverse order of disassembly.
4. Be careful with the tube, vibrator shaft and end cap, these parts must not be lubricated. Make sure that the components are clean and dry to ensure the function of the poker vibrator.

## Storage

- ◆ Clean the machine properly before storage, in order to avoid hazardous substances. See section "Dust and fume hazard".
- ◆ Always store the machine in a dry place.
- ◆ Keep the machine in a safe place, out of the reach of children and locked up.

## Disposal

A used machine must be treated and disposed in such way that the greatest possible portion of the material can be recycled and any negative influence on the environment is kept as low as possible, and in accordance with local restrictions.

Always send used filters and drained oil remnants to environmentally correct disposal.



МАГАЗИН  
БАШ МАЙСТОРА®  
ПРОФЕСИОНАЛНИ РЕШЕНИЯ

## Technical data

### Tool data AA

Type	AA27	AA37	AA47	AA67	AA77
Tube diameter mm (in.)	25 (1)	39 (1.53)	50 (1.97)	63 (2.48)	75 (2.95)
Tube length mm (in.)	334 (13.15)	366 (14.40)	420 (16.53)	500 (19.68)	510 (20.07)
Total weight kg (lbs)	10 (22.04)	19 (41.88)	23 (50.70)	25 (55.11)	29 (63.93)
Flexible shaft length m (ft.)					
Max driving speed (electric drive unit) r.p.m.	3,600	3,600	3,600	3,600	3,600
Max driving speed (gasoline drive unit) r.p.m.	2,900	2,900	2,900	2,900	2,900
Weighted effective acceleration uncertainty (K) m/s <sup>2</sup> *(ft/s <sup>2</sup> *)	2.46 -	1.56 0.3	3.52 -	2.66 -	3.16 0.41

\* Weighted effective acceleration measured in water driving one poker, on the hose, at 2 metres from the end of the poker (m/s<sup>2</sup>), according to EN ISO 5349-1.

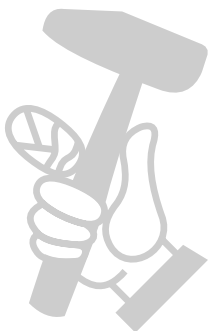

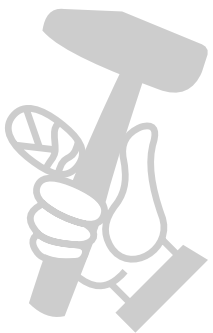

МАГАЗИН  
**БАШ МАЙСТОРА**<sup>®</sup>  
ПРОФЕСИОНАЛНИ РЕШЕНИЯ

Any unauthorized use or copying of the contents or any part thereof is prohibited.  
This applies in particular to trademarks, model denominations, part numbers, and drawings.

© 2013 Atlas Copco Construction Tools AB | No. 9800 1163 01a | 2013-02-14