



Operating instructions

(Original Operating Instructions – German)

Pan Mixer

TMX 1000

Art.nr. 37080 (230 V EU)

TMX 1500

Art.nr. 37081 (230 V EU)

Keep for future use!

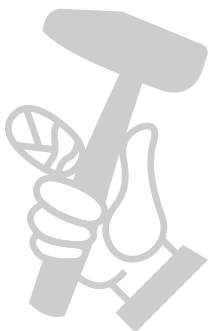

Overview of machine elements

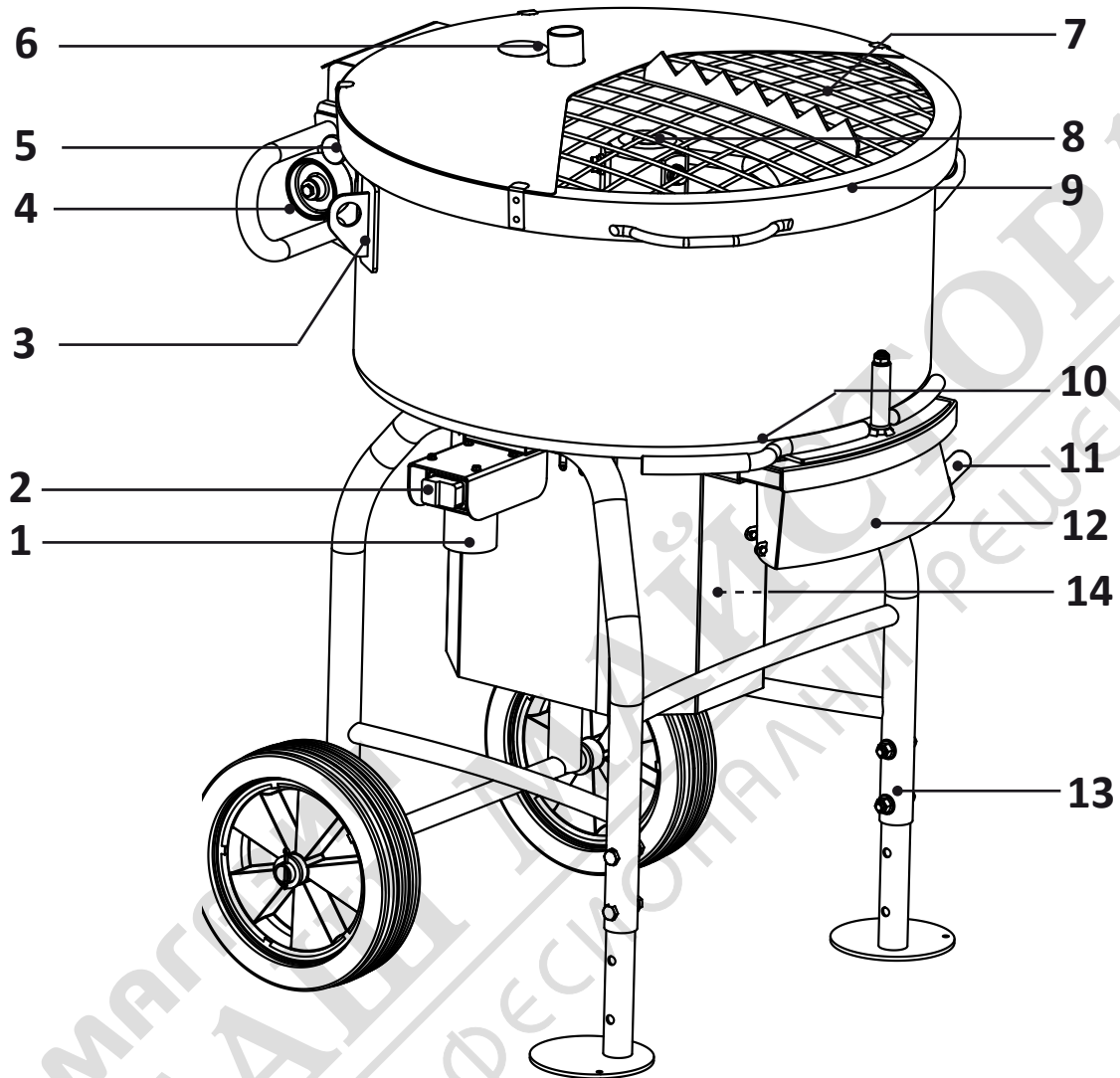



- | | | | |
|---|-------------------------------|----|---|
| 1 | Mains plug | 8 | Mixing tool |
| 2 | ON/OFF switch | 9 | Lid with protective grating |
| 3 | Lashing eyes | 10 | Lever for emptying |
| 4 | Transport rollers | 11 | Vibrating device |
| 5 | Unlocking mechanism for lid | 12 | Discharge chute |
| 6 | Connection for vacuum cleaner | 13 | Foot |
| 7 | Bag ripper | 14 | Thermal overload protection (only TMX 1500) |

Signs and symbols

Warnings

The following symbols and signal words are used in this documentation.

Symbol	Meaning
DANGER 	If this signal word is used, death or serious injuries will occur if the respective precautionary measures are not observed.
WARNING 	If this signal word is used, death or serious injuries may occur if the respective precautionary measures are not observed.
CAUTION 	If this signal word is used, minor injuries may occur if the respective precautionary measures are not observed.
ATTENTION	If this signal word is used, malfunctions or material damage may occur if the respective precautionary measures are not observed.
IMPORTANT	If this signal word is used, operating tips or cross-references will follow.

Structure of warnings

DANGER

The first line describes the type and source of the danger
The second line describes the consequences if no danger prevention measures are taken.
→ The last line describes danger prevention measures.





WARNING



Risk of injuries due to non-observance of the safety symbols
Non-observance of the warnings on the device and in the operating instructions can lead to injuries and further dangers.
→ Observe the warnings on the device and in the operating instructions.



The following special safety symbols are used in respective passages in these operating instructions:

Mandatory signs

Symbol	Explanation	Symbol	Explanation
	Observe information		Pull the mains plug after every use. Pull the mains plug prior to opening the housing.

Symbol	Explanation	Symbol	Explanation
	Warning against a danger point		Warning against dangerous electrical voltage

Technical data

Model	TMX 1000	TMX 1500
Capacity, mixing bucket, nominal	115 litres	150 litres
Maximum mixing volume	80 litres	120 litres
Output	2 kW /230 V~ 50 Hz / 8.1 A	2,8 kW /230 V~ 50 Hz / 12.5 A
Speed, mixing tool	30 rpm (no load)	30 rpm (no load)
Weight (empty)	131 kg	138 kg
Protection class	IP 44	IP 44
Dimensions	840 x 755 x 1170 mm	840 x 755 x 1260 mm
Article number TMX	37080 (230V - EU)	37081 (230 V-EU)
Noise emission according to 2006/42/EC		
Sound power L_{WA} / Guaranteed sound level	86 dB (A)	85 dB (A)
Measuring inaccuracy K_{pA+WA}	1,2 dB (A)	1,2 dB (A)

Declaration of EC Conformity

We hereby declare on our sole authority that this product complies with the following standards or normative documents:

EN 12151:2007; EN 20204-1:2006/+A1: 2009; EN 61000-3-2:2014; EN 61000-3-3:2013; EN 55014-1:2006/+A1: 2009/+A2:2011; EN 55012-2:2015; EN ISO 3744:2010
as per the provisions of Directives 2014/30/EU, 2006/42 EC, 2011/65/EU; 2000/14/EC



Gaimersheim, 16/02/2017
A. Essing, Executive Management

Technical documentation to be requested from"
Collomix GmbH
Technical Development Department
Daimlerstr. 9, 85080 Gaimersheim
Germany

Scope of delivery

- 1 Machine with mixing tool
- 1 Operating instructions

About this document

These instructions use symbols and labels that help you in finding information quickly. Read the respective explanations in the following section. Read the safety and warning information in these instructions particularly thoroughly. You can find the safety information starting from page 6. Refer to the chapter introductions and passages leading up to instructions for warnings.

The copyright for images and texts remains with Collomix GmbH.

You must read the operating instructions prior to initial commissioning. Observe the safety information. Keep for future use. This documentation is not monitored by a change service.

For your safety

The TMX mixer was developed, produced and tested complying with the fundamental safety requirements. Despite that, there are residual risks.

- For this reason, read the operating instructions prior to operating the machine.
- Store the operating instructions readily available at the machine.
- Pass on the operating instructions to any subsequent owners.
- Despite all precautions taken, non-obvious residual risks may exist. Residual risks can be reduced by observing the safety information, the intended use and the operating instructions overall.

Consideration and caution reduce the risk of personal injuries and damage.

- Electrical hazard if improper connection lines are used.
- Contact with live parts if electrical components are open.



Operating hours (Outdoor Directive)

According to the German Machine Noise Prevention Regulation dated September 2002, concrete mixers may not be operated between the hours of 8:00 pm to 7:00 am in pure, general and special residential areas, small housing estates, special areas for recreational purposes, treatment and clinic areas, and areas for the accommodation of foreigners and tourists, as well as on hospital and hospice premises on Sundays and holidays as well as on workdays.

- Please also observe any regional noise protection regulations.

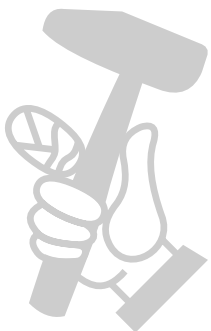

Safety information



Read and observe this information prior to using the device! Non-observance can result in direct consequences for your health and physical integrity, as well as for the health and physical integrity of third parties.



RCD 30mA

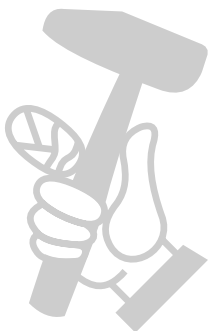

- ▶ The machine may only be used and maintained by persons familiar with the operating instructions and the applicable regulations regarding occupational safety and accident prevention.
- ▶ The machine may only be used in proper technical conditions as well as for the intended purpose and in a safety- and danger-conscious manner. In particular, damage that can impact the safety must be corrected immediately. Do not put the machine into operation!
- ▶ Repairs may only be carried out by recognised expert personnel or the manufacturer.
- ▶ Do not operate the device in rooms with flammable atmosphere. Risk of explosion!
- ▶ Do not mix any solvent-containing substances with a flash point below 21 °C.
- ▶ Do not reach with your hand or objects into the mixing device during ongoing mixing operation. Risk of crushing!
- ▶ Wear tight-fitting clothes, safety shoes and no jewellery during work. Wear a hairnet for long hair.
- ▶ The use of a dust extraction and wearing a dust mask are recommended as protection against health-hazardous dusts in the area of the machine.
- ▶ Wear safety gloves and safety shoes while working with the machine.
- ▶ Ensure a firm and level location. Make sure that the device cannot tilt.
- ▶ Observe the electrical regulation at the usage location when setting up the device.
- ▶ Make sure that the voltage indicated on the rating plate matches the mains voltage.
- ▶ Realisation of the connection lines according to IEC 60245 (H 07 RN-F) with a wire cross-section of at least 3 x 1.5 mm² for a cable length of up to maximum 25 m, or 3 x 2.5 mm² for a cable length greater than 25 m
- ▶ Only use connection lines with a splash-proof rubber plug connection for difficult conditions.
- ▶ Do not connect the device to standard electrical sockets. Always connect the devices via a **residual current device (RCD) with a response current of 30 mA** or less.
- ▶ If a cable reel is used, the cable must be fully unwound. There is a risk of a cable fire due to heating. A loss of power may occur as well, leading to the undervoltage protection being triggered.
- ▶ Repairs on electrical components may only be carried out by a recognised electrician, complying with the local regulations.
- ▶ Electrical operating equipment must be subjected to a regular inspection by an electrician (according to German Social Accident Insurance DGUV 3).
- ▶ Keep the device away from rain and moisture. Water penetration into an electrically operated machine increases the risk of an electric shock.
- ▶ Always pull the mains plug during non-operation, maintenance or when replacing the mixing tool.
- ▶ Do not disconnect the plug from the socket by pulling on the cord. Protect the cable against heat, oil, bending and sharp edges.
- ▶ Check the cable for damage or defects prior to use.
- ▶ Wait, until the device and/or tool comes to a complete standstill. Rotating tools can get stuck and cause injuries or damage.
- ▶ Only remove material samples with the device at standstill.
- ▶ Acute risk of accidents and injuries if the safety functions are disabled on purpose. In this

case, the warranty shall become void.

- ▶ Check the machine regularly for flawless function and damage. Do not put the machine in operation with damaged or defective safety components.
- ▶ Do not clean the machine using a high-pressure cleaner or hose – risk of electric shock!
- ▶ Do not expose the machine to any rain, not even during transportation.
- ▶ Observe the processing and safety information of the manufacturer for the material to be mixed.
- ▶ The machine must be firmly lashed in at least three directions for vehicle transport.
- ▶ Only operate the machine with the TMX mixing tool that is suitable for the machine.
- ▶ Only use original spare parts. The use of third-party spare parts may lead to accidents of the user. The manufacturer shall not be liable for any resulting damage.

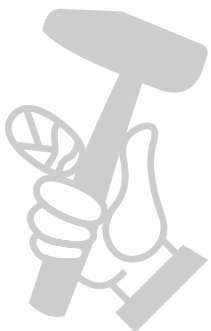

МАГАЗИН МАЙСТОРА
БАШ ПРОФЕСИОНАЛНИ РЕШЕНИЯ

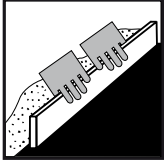

Intended use

The TMX model is a mixing device that is suitable for mixing soft to viscoplastic material as well as hard and granular material. Examples include:

- All types of mortar
- Soft to plastic screeds and concretes with additives up to 16 mm
- Lime-cement plaster
- Different cement-based adhesives
- Heavy epoxy resin mortar
- Terrazzo (TMX 1000 with additional available rubber lips)
- Dry fill materials

as they are used in the construction industry.

The recommended mixing capacity amounts to a maximum of 80 litres per mixture (material-dependent). It is recommended to test the necessary material mixing time at the beginning of your work.

Observe the processing information of the material manufacturer regarding the used material.

Any other use of the machine or any use beyond this scope is considered unintended and thus improper. Safety and its protection can be impacted in this case. Collomix GmbH shall not be liable for any resulting damage. Intended use also includes:

- Compliance with all information in the operating instructions
- Compliance with all safety information
- Compliance with inspection and maintenance work.

The user shall be liable for damage resulting from non-intended use.

Foreseeable misuse

Reasonably foreseeable misuse that could result in danger for the user, third parties or the machine includes:

- Use of the machine and its accessories contrary to the intended use.
- Operation of the machine using a mixing tool different from the specified one.
- Use of damaged containers or containers not suitable for the mixer.
- Mixing of liquid and runny materials.
- Mixing of flammable or explosive substances.
- Mixing of electrically conducting substances.
- Mixing of chemically aggressive substances and corrosive liquids.
- Mixing of food items.
- Operation of the machine outside of the physical usage limits described in chapter "Commissioning/operation".
- Bucket overfilling
- Use of water jets or high-pressure cleaners for cleaning
- Changes to the mixer as well as add-ons or retrofits without previous agreement with Collomix GmbH.
- Operation of the machine contrary to the provisions of the operating instructions with respect to safety information, installation, operation, maintenance, setup and malfunctions.
- Bypassing, removal or disabling of safety and protection devices of the machine.
- Operation of the machine in the case/with obvious malfunctions
- Repair, cleaning and maintenance work without disconnecting the mixer from the power supply

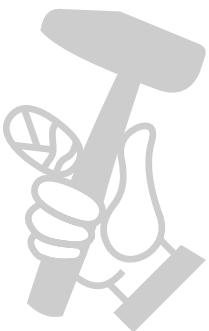

Functionality

The machine consists of a mobile frame with a permanently mounted mixing bucket made of steel sheet. A 3-arm mixing tool rotates in the mixing drum around a central drive axis.

Ideally, the mixer is first filled with the dry material and then the necessary amount of water is added to the running machine

The materials are usually mixed and ready for use within three to five minutes. Observe the information of the material manufacturer and check the mixing quality using a test mixture.

Open the segment slidegate at the bottom of the bucket to empty the mixer during operation. The rotating mixing tool conveys the material to the discharge chute.

Transport information

The machine is delivered on a pallet without wheels. Observe the assembly instructions.

The empty weight of the machine amounts to **131 kg** (TMX 1000) / **138 kg** (TMX 1500).



ATTENTION!

The machine must always be sufficiently secured against tilting and rolling away using several transport straps for vehicle transport. Non-secured loads can result in serious personal injury and material damage.

Lash the machine via the lashing eyes with lashing strips of a sufficient size.

The lashing eyes are not suitable for transportation by crane.



Assembly

The following tools are required for initial assembly:

1 x open-end wrench SW 10; 2 x open-end wrench SW 17

Removal of the transport lock:

Loosen the screw connections of the four feet on the pallet. (Open-end wrench SW 10)

Adjusting the height:

ATTENTION!

Risk of tipping! Seek the assistance of a second person in this regard.

Loosen the 4 screws on the two front feet using two open-end wrenches SW 17. Tilt the machine until it becomes possible to insert the 4 screws into the upper bores. Then tighten the screws again.

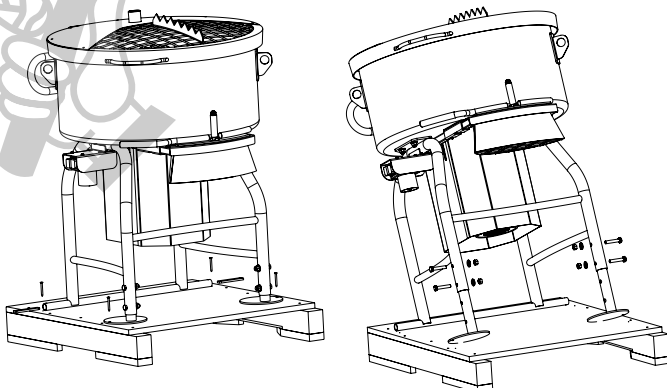

Mounting the wheels:

Pay attention to the correct installation of the wheels. The inside of the wheels is marked with an adhesive label.

Before you put the wheel on the relevant axle, one of the accompanying washers needs to be inserted. Once this has been done, attach the wheel and one further washer to conclude. Secure the wheels with the accompanying cotters as well.

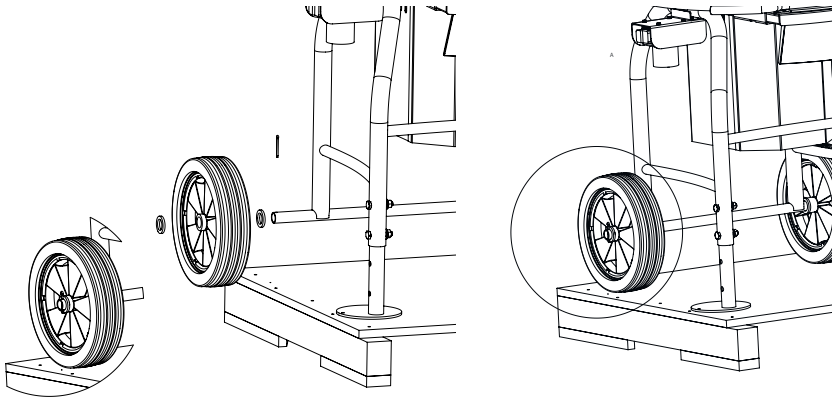

Prior to commissioning

The machine must always be checked for damage prior to each commissioning.

Make sure that the machine is standing securely on a firm and level surface. Risk of tipping!

Electrical installation

Check that the voltage indicated on the type plate matches the available mains voltage.

Connect the mains plug of the machine to the power supply socket using a suitable extension cord (type H07 RN-F, at least $\varnothing 1.5^2$). This socket must feature a residual current device (RCD). Do not connect to standard electrical sockets.

Opening the lid

Pull the release knob with one hand and lift the lid at the same time with the second hand. The lid is locked when in open state. The release knob needs to be pulled again to close the lid.

Connecting the vacuum cleaner

In order to significantly reduce the dust load when filling the material and at the start of the mixing process, we recommend connecting a deduster to the hose supports ($\varnothing 35$ mm) of the lid. The deduster used must comply with dust class "M".

Mixing tool

Check whether the mixing tool is correctly mounted and fully seated on the shaft. If necessary, you can adjust the individual mixing paddles.

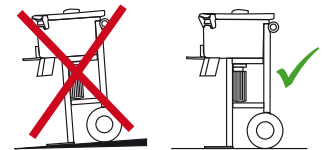

RCD 30mA



Operation

WARNING

Risk of injuries due to rotating mixing tool.

Do not reach into the mixing drum or handle tools in the mixing drum during mixing.



ATTENTION

Only use the mixer for the tasks listed in chapter "Intended use". Observe the safety information respectively.

- ▶ Close the protective grating and make sure that it is locked.
- ▶ Switch on the mixer. Press the green start button.
- ▶ If installed, switch on the vacuum cleaner.
- ▶ Place the material bag with its broad side on the grid cover with the bag ripper and move it back and forth slightly until the sack is fully open. Gradually fill the content of the bag into the drum.
- ▶ Fill the necessary amount of water into the mixing drum.
- ▶ Pay attention during the mixing process to determine whether the material is mixed to a sufficient extent.
- ▶ To empty the mixing drum, open the bottom segment slide using the lever. If the material comes to a standstill in the discharge chute, emptying can be accelerated by vibrating movements with the lever attached on the right.
- ▶ To empty the mixing drum, open the bottom segment slide using the lever.
- ▶ Empty the mixed material into a bucket or wheelbarrow.
- ▶ Press the red OFF button "0" to switch off the machine. The machine comes to a stop.

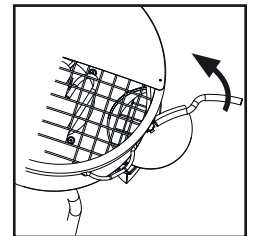
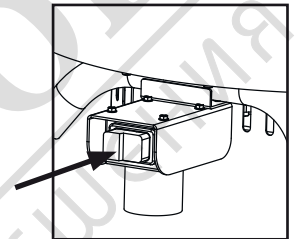

The machine is fitted with a **protection switch**. It switches the machine off in the event of overloading/overheating. Let the motor cool down and restart the machine.

The machine is fitted with an **undervoltage trigger**. If it triggers, the machine is stopped. This may occur due to the following reasons:

- Voltage drop in the mains supply
- Supply cable too long
- Power supply disconnected

Restart after the malfunction is corrected.

IMPORTANT:

Observe the information in the technical data sheets of the material manufacturers.

The necessary mixing time depends on the quantity and viscosity of the material.

Removing the mixing tool

Unlock and open the cover with the protective grating.

The mixing tool rests on the hexagonal pin of the drive shaft without additional attachment.

You can easily lift the mixing tool off of the shaft. It may happen that you need to move the tool back and forth a little if it has strutted apart.

The individual mixing shovels can be replaced. To do this, loosen the screw connections on the arms of the mixing tool.



Troubleshooting

Malfunction	Cause	Remedy
Machine does not start	<ul style="list-style-type: none"> • Supply cable too long and/or cable cross-section too small • Plug not inserted • No mains voltage present • Capacitor defective 	<ul style="list-style-type: none"> • Check cable cross-section, must be 1.5 mm², shorten supply cable • Insert plug • Check mains voltage • Replace starting capacitor*
Machine switches off after a short time, cannot be switched on again	<ul style="list-style-type: none"> • Thermal overload protection triggered (overload of the machine) - - only for TMX 1500 • Supply cable too long and/or cable cross-section too small • Cable was pulled from the mains plug • Voltage drop in the power supply • Capacitor defective 	<ul style="list-style-type: none"> • Let machine cool down (at least 2 min), reduce mix as needed • Check cable cross-section, must be 1.5 mm², shorten supply cable, <25 meter • Insert cable again • Check mains voltage • Replace starting capacitor*
Machine does not start up when filled, remains at a standstill	<ul style="list-style-type: none"> • Mixing quantity too high • Mixed material too stiff 	<ul style="list-style-type: none"> • Reduce the material volume

* Work on live components may only be carried out by a qualified electrician!



Care and maintenance

The mixer must always be disconnected from the power supply by pulling the mains plug prior to any maintenance and cleaning work.

Always ensure ease of movement for all moving parts.

The mixer is largely maintenance-free. The drive shaft is supported by ball bearings with permanent lubrication.

Clean the machine immediately after use. Do not let material deposits dry.

Remove the mixing tool from the hexagon shaft and clean it outside of the mixer.

Do not tap the mixing tool and mixing tub using a hammer. Bent mixing tools can lead to damage to the device and poor mixing results.

Replace damaged, bent or worn machine parts.

Treat moving parts, such as the bottom segment slidegate, extendable discharge chute and hexagons shaft from time to time with spray oil.



Repair

Have repairs on the electrical system only performed by expert personnel or Collomix Factory Service.

Only use original Collomix accessories and spare parts.

Service instructions and the current list of spare parts can be found on our homepage: www.collomix.com

DANGER

Danger to life due to dangerous electrical voltage

Never open the covers or safety devices of the machine. Repairs may only be performed by trained expert personnel. After repair completion, verify and document the proper condition of all safety devices and the electrical equipment.

Do not reconstruct, change or remove safety-relevant parts!

Additional add-ons may not impact safety and must be approved by the manufacturer.

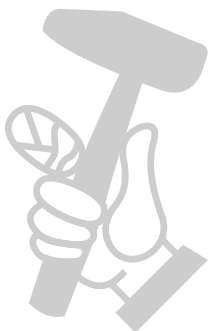

МАГАЗИН МАЙСТРОВ
БАШ МАЙСТРОВ
ПРОФЕСИОНАЛНИ РЕШЕНИЯ

Consumables

The following consumables are available:

Part	Art. no.
Mixing tool TMX 1000	37250
Mixing tool TMX 1500	37251

Disposal

Recycle the device, accessories and packaging in an environmental friendly manner. Do not dispose of in household waste.

Non-functional electrical equipment can be recycled at public collection centres for electrical waste.



Warranty

The manufacturer offers a product warranty within the scope of the delivery terms and in accordance with legal / country-specific regulations. Please include your payment receipt or delivery note with any warranty claims.

Please return the device to us if you detect any irregularities. Complaints / claims can only be considered if the device is delivered to the Collomix Service department in a complete and undismantled state.

Any damage resulting from normal wear, overload, improper handling, non-approved accessories or insufficient maintenance shall be exempt from the warranty.

Any repairs carried out by third parties shall release us from any warranty obligation.

Any structural or functional changes to the device not authorised by us shall result in the invalidation of the warranty as well as the declaration of conformity.

Please enclose a proof of purchase with a warranty claim.

Any warranty and liability claims are excluded in the case of personal injuries and/or material damage, if they are caused by one or several of the following causes:

- Unintended use of the machine
- Improper commissioning, operation and maintenance of the machine
- Damage due to excessive contamination and/or insufficient cleaning.
- Unauthorised structural changes of the machine
- Improperly performed repairs and/or use of third-party spare parts.

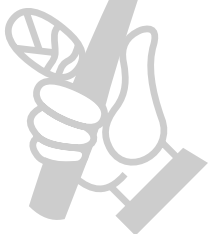

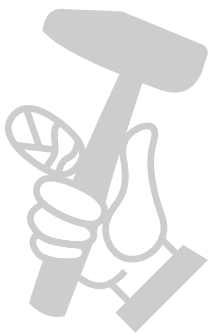

МАГАЗИН
БАШ МАЙСТОРА[®]
ПРОФЕСИОНАЛНИ РЕШЕНИЯ



Manufacturer:
Collomix GmbH
Daimlerstraße 9
85080 Gaimersheim
Germany
Telephone: +49 (0)8458 3298-0
Fax: +49 (0)8458 3298-30
info@collomix.de
www.collomix.com

Subject to change
© Collomix GmbH
2021-03
Art.no. 07034-011