

DEWALT®

МАГАЗИН
БАШ МАЙСТОРА
ПРОФЕСИОНАЛНИ РЕШЕНИЯ

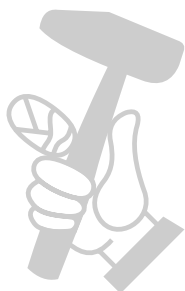

www.DEWALT.com

D25733

D25773

Fig. A

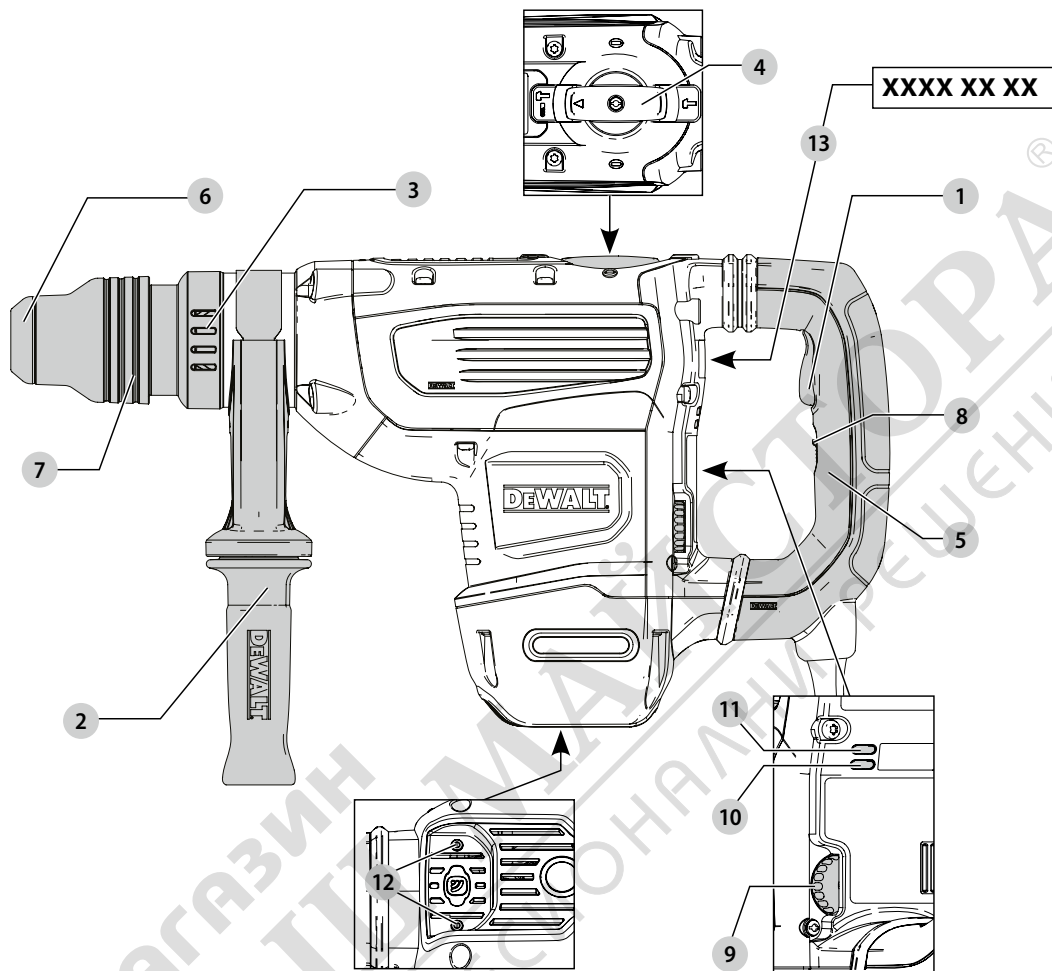

Fig. B

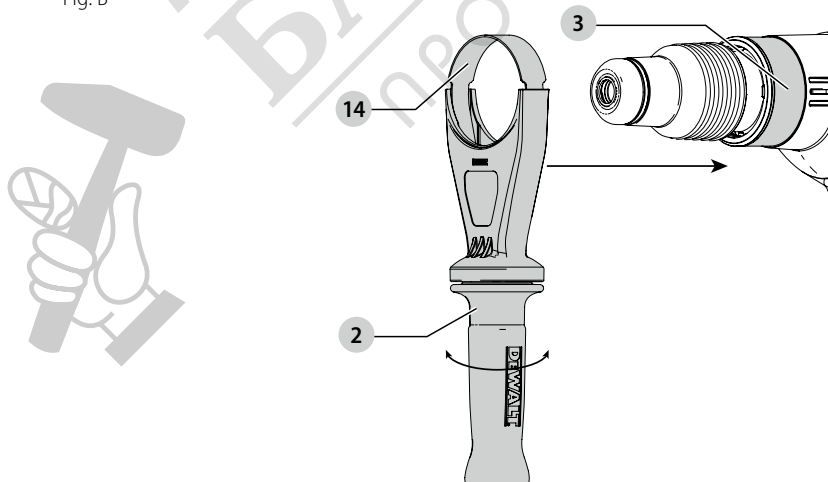

Fig. C

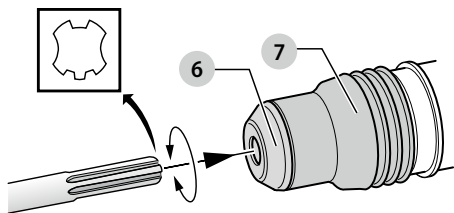
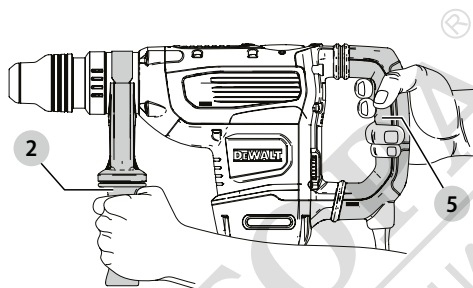

Fig. D



МАГАЗИН
БАШ МАЙСТЕР
ПРОФЕСІОНАЛНИ РЕШЕНИЯ

HEAVY-DUTY ROTARY HAMMERDRILL

D25733, D25773

Congratulations!

You have chosen a DEWALT tool. Years of experience, thorough product development and innovation make DEWALT one of the most reliable partners for professional power tool users.

Technical Data

| | | D25733 | D25773 |
|---|-------------------|-----------|-----------|
| Voltage | V _{AC} | 230 | 230 |
| (U.K. & Ireland only) | V _{AC} | 230/115 | 230/115 |
| Type | | 2 | 2 |
| No-load speed | min ⁻¹ | 177–355 | 145–290 |
| No-load beats per minute | bpm | 1350–2705 | 1105–2210 |
| Power input | W | 1600 | 1700 |
| Single impact energy (EPTA 05/2009) | J | 13.3 | 19.4 |
| Optimum drilling range into concrete | mm | 25–38 | 28–42 |
| Maximum drilling range in concrete | mm | 48 | 52 |
| Maximum core drilling range in concrete | mm | 40–125 | 40–150 |
| Tool holder | | SDS MAX | SDS MAX |
| Weight | kg | 9.5 | 10.6 |

Noise values and vibration values (tri-ax vector sum) according to EN62841-2-6:

| | | | |
|---|-------|-----|-----|
| L _{PA} (emission sound pressure level) | dB(A) | 98 | 100 |
| L _{WA} (sound power level) | dB(A) | 109 | 111 |
| K (uncertainty for the given sound level) | dB(A) | 3 | 3 |

| | | | |
|--|------------------|------|-------|
| Drilling | | | |
| Vibration emission value a _{h,HD} = | m/s ² | 9.6* | 12.4* |
| Uncertainty K = | m/s ² | 1.5 | 1.5 |
| Chiselling | | | |
| Vibration emission value a _{h,Cheq} = | m/s ² | 9.0* | 11.7* |
| Uncertainty K = | m/s ² | 1.5 | 1.5 |

*Measured at the side handle. Side handle vibration is higher than vibration at the main handle.

The vibration and/or noise emission level given in this information sheet has been measured in accordance with a standardised test given in EN62841 and may be used to compare one tool with another. It may be used for a preliminary assessment of exposure.



WARNING: The declared vibration and/or noise emission level represents the main applications of the tool. However if the tool is used for different applications, with different accessories or poorly maintained, the vibration and/or noise emission may differ. This may significantly increase the exposure level over the total working period.

An estimation of the level of exposure to vibration and/or noise should also take into account the times when the

tool is switched off or when it is running but not actually doing the job. This may significantly reduce the exposure level over the total working period.

Identify additional safety measures to protect the operator from the effects of vibration and/or noise such as: maintain the tool and the accessories, keep the hands warm (relevant for vibration), organisation of work patterns.

EC-Declaration of Conformity

Machinery Directive



Heavy-Duty Rotary Hammerdrill D25733, D25773

DEWALT declares that these products described under

Technical Data are in compliance with:

2006/42/EC, EN60745-1:2009+A11:2010, EN60745-2-6:2010.

These products also comply with Directive 2014/30/EU and 2011/65/EU. For more information, please contact DEWALT at the following address or refer to the back of the manual.

The undersigned is responsible for compilation of the technical file and makes this declaration on behalf of DEWALT.

Markus Rompel
Vice President of Engineering, PTE-Europe
DEWALT, Richard-Klinger-Straße 11,
D-65510, Idstein, Germany
01.04.2020



WARNING: To reduce the risk of injury, read the instruction manual.

Definitions: Safety Guidelines

The definitions below describe the level of severity for each signal word. Please read the manual and pay attention to these symbols.



DANGER: Indicates an imminently hazardous situation which, if not avoided, **will** result in **death or serious injury**.



WARNING: Indicates a potentially hazardous situation which, if not avoided, **could** result in **death or serious injury**.



CAUTION: Indicates a potentially hazardous situation which, if not avoided, **may** result in **minor or moderate injury**.

NOTICE: Indicates a practice **not related to personal injury** which, if not avoided, **may** result in **property damage**.



Denotes risk of electric shock.



Denotes risk of fire.

General Power Tool Safety Warnings



WARNING: Read all safety warnings, instructions, illustrations and specifications provided with this power tool. Failure to follow all instructions listed below may result in electric shock, fire and/or serious injury.

SAVE ALL WARNINGS AND INSTRUCTIONS FOR FUTURE REFERENCE

The term "power tool" in the warnings refers to your mains-operated (corded) power tool or battery-operated (cordless) power tool.

1) Work area safety

- Keep work area clean and well lit.** Cluttered or dark areas invite accidents.
- Do not operate power tools in explosive atmospheres, such as in the presence of flammable liquids, gases or dust.** Power tools create sparks which may ignite the dust or fumes.
- Keep children and bystanders away while operating a power tool.** Distractions can cause you to lose control.

2) Electrical safety

- Power tool plugs must match the outlet. Never modify the plug in any way. Do not use any adapter plugs with earthed (grounded) power tools.** Unmodified plugs and matching outlets will reduce risk of electric shock.
- Avoid body contact with earthed or grounded surfaces such as pipes, radiators, ranges and refrigerators.** There is an increased risk of electric shock if your body is earthed or grounded.
- Do not expose power tools to rain or wet conditions.** Water entering a power tool will increase the risk of electric shock.
- Do not abuse the cord. Never use the cord for carrying, pulling or unplugging the power tool. Keep cord away from heat, oil, sharp edges or moving parts.** Damaged or entangled cords increase the risk of electric shock.
- When operating a power tool outdoors, use an extension cord suitable for outdoor use.** Use of a cord suitable for outdoor use reduces the risk of electric shock.
- If operating a power tool in a damp location is unavoidable, use a residual current device (RCD) protected supply.** Use of an RCD reduces the risk of electric shock.

3) Personal safety

- Stay alert, watch what you are doing and use common sense when operating a power tool. Do not use a power tool while you are tired or under the influence of drugs, alcohol or medication.** A moment

of inattention while operating power tools may result in serious personal injury.

- Use personal protective equipment. Always wear eye protection.** Protective equipment such as dust mask, non-skid safety shoes, hard hat, or hearing protection used for appropriate conditions will reduce personal injuries.
- Prevent unintentional starting. Ensure the switch is in the off position before connecting to power source and/or battery pack, picking up or carrying the tool.** Carrying power tools with your finger on the switch or energising power tools that have the switch on invites accidents.
- Remove any adjusting key or wrench before turning the power tool on.** A wrench or a key left attached to a rotating part of the power tool may result in personal injury.
- Do not overreach. Keep proper footing and balance at all times.** This enables better control of the power tool in unexpected situations.
- Dress properly. Do not wear loose clothing or jewellery. Keep your hair, clothing and gloves away from moving parts.** Loose clothes, jewellery or long hair can be caught in moving parts.
- If devices are provided for the connection of dust extraction and collection facilities, ensure these are connected and properly used.** Use of dust collection can reduce dust-related hazards.

4) Power tool use and care

- Do not force the power tool. Use the correct power tool for your application.** The correct power tool will do the job better and safer at the rate for which it was designed.
- Do not use the power tool if the switch does not turn it on and off.** Any power tool that cannot be controlled with the switch is dangerous and must be repaired.
- Disconnect the plug from the power source and/or the battery pack from the power tool before making any adjustments, changing accessories, or storing power tools.** Such preventive safety measures reduce the risk of starting the power tool accidentally.
- Store idle power tools out of the reach of children and do not allow persons unfamiliar with the power tool or these instructions to operate the power tool.** Power tools are dangerous in the hands of untrained users.
- Maintain power tools. Check for misalignment or binding of moving parts, breakage of parts and any other condition that may affect the power tool's operation. If damaged, have the power tool repaired before use.** Many accidents are caused by poorly maintained power tools.
- Keep cutting tools sharp and clean.** Properly maintained cutting tools with sharp cutting edges are less likely to bind and are easier to control.
- Use the power tool, accessories and tool bits etc., in accordance with these instructions taking into**

account the working conditions and the work to be performed. Use of the power tool for operations different from those intended could result in a hazardous situation.

5) Service

- a) **Have your power tool serviced by a qualified repair person using only identical replacement parts.** This will ensure that the safety of the power tool is maintained.

Additional Safety Instructions for Rotary Hammers

- **Wear ear protectors.** Exposure to noise can cause hearing loss.
- **Use auxiliary handles supplied with the tool.** Loss of control can cause personal injury.
- **Hold power tool by insulated gripping surfaces, when performing an operation where the cutting accessory may contact hidden wiring or its own cord.** Cutting accessory contacting a "live" wire may make exposed metal parts of the power tool "live" and could give the operator an electric shock.
- **Use clamps or other practical way to secure and support the workpiece to a stable platform.** Holding the work by hand or against your body is unstable and may lead to loss of control.
- **Wear safety goggles or other eye protection.** Hammering operations cause chips to fly. Flying particles can cause permanent eye damage. Wear a dust mask or respirator for applications that generate dust. Ear protection may be required for most applications.
- **Keep a firm grip on the tool at all times.** Do not attempt to operate this tool without holding it with both hands. It is recommended that the side handle be used at all times. Operating this tool with one hand will result in loss of control. Breaking through or encountering hard materials such as re-bar may be hazardous as well. Tighten the side handle securely before use.
- **Do not operate this tool for long periods of time.** Vibration caused by hammer action may be harmful to your hands and arms. Use gloves to provide extra cushion and limit exposure by taking frequent rest periods.
- **Do not recondition bits yourself.** Chisel reconditioning should be done by an authorized specialist. Improperly reconditioned chisels could cause injury.
- **Wear gloves when operating tool or changing bits.** Accessible metal parts on the tool and bits may get extremely hot during operation. Small bits of broken material may damage bare hands.
- **Never lay the tool down until the bit has come to a complete stop.** Moving bits could cause injury.
- **Do not strike jammed bits with a hammer to dislodge them.** Fragments of metal or material chips could dislodge and cause injury.
- **Slightly worn chisels can be resharpened by grinding.**
- **Keep the power cord away from the rotating bit.** Do not wrap the cord around any part of your body. An electric cord

wrapped around a spinning bit may cause personal injury and loss of control.



WARNING: We recommend the use of a residual current device with a residual current rating of 30mA or less.

Residual Risks

The following risks are inherent to the use of rotary hammers:

- Injuries caused by touching the rotating parts or hot parts of the tool.

In spite of the application of the relevant safety regulations and the implementation of safety devices, certain residual risks cannot be avoided. These are:

- Impairment of hearing.
- Risk of squeezing fingers when changing the accessory.
- Health hazards caused by breathing dust developed when working in concrete and/or masonry.
- Risk of personal injury due to flying particles.
- Risk of burns due to accessories becoming hot during operation.
- Risk of personal injury due to prolonged use.

Electrical Safety

The electric motor has been designed for one voltage only. Always check that the power supply corresponds to the voltage on the rating plate.



Your DEWALT tool is double insulated in accordance with EN60745; therefore no earth wire is required.



WARNING: 115 V units have to be operated via a fail-safe isolating transformer with an earth screen between the primary and secondary winding.

If the supply cord is damaged, it must be replaced only by DEWALT or an authorised service organisation.

Mains Plug Replacement (U.K. & Ireland Only)

If a new mains plug needs to be fitted:

- Safely dispose of the old plug.
- Connect the brown lead to the live terminal in the plug.
- Connect the blue lead to the neutral terminal.



WARNING: No connection is to be made to the earth terminal.

Follow the fitting instructions supplied with good quality plugs. Recommended fuse: 13 A.

Using an Extension Cable

If an extension cable is required, use an approved 3-core extension cable suitable for the power input of this tool (see **Technical Data**). The minimum conductor size is 1.5 mm²; the maximum length is 30 m.

When using a cable reel, always unwind the cable completely.

Package Contents

The package contains:

- 1 Rotary hammerdrill
- 1 Side handle
- 1 Kit box
- 1 Instruction manual
- Check for damage to the tool, parts or accessories which may have occurred during transport.
- Take the time to thoroughly read and understand this manual prior to operation.

Markings on Tool

The following pictograms are shown on the tool:



Read instruction manual before use.



Wear ear protection.



Wear eye protection.

Date Code Position (Fig. A)

The date code **13**, which also includes the year of manufacture, is printed into the housing.

Example:

2020 XX XX
Year of Manufacture

Description (Fig. A)



WARNING: Never modify the power tool or any part of it. Damage or personal injury could result.

- | | |
|-------------------------|--|
| 1 Trigger switch | 9 Electronic speed and impact control dial |
| 2 Side handle | 10 Red anti-rotation system indicator LED |
| 3 Front Barrel (Collar) | 11 Yellow brushwear indicator LED |
| 4 Mode selector switch | 12 DeWALT tool tag mounting holes |
| 5 Main handle | 13 Date code |
| 6 Bit holder | |
| 7 Locking sleeve | |
| 8 Lock-on switch | |

Intended Use

Your heavy-duty rotary hammer is designed for professional masonry drilling and chiseling applications.

DO NOT use under wet conditions or in the presence of flammable liquids or gases.

Your heavy-duty rotary hammer is a professional power tool.

DO NOT let children come into contact with the tool.

Supervision is required when inexperienced operators use this tool.

- **Young children and the infirm.** This appliance is not intended for use by young children or infirm persons without supervision.

- This product is not intended for use by persons (including children) suffering from diminished physical, sensory or mental abilities; lack of experience, knowledge or skills unless they are supervised by a person responsible for their safety. Children should never be left alone with this product.

Soft Start Feature

The soft start feature allows the tool to accelerate slowly, thus preventing the drill bit from walking off the intended hole position when starting.

The soft start feature also reduces the immediate torque reaction transmitted to the gearing and the operator if the hammer is started with the drill bit in an existing hole.

Active Vibration Control (AVC) System

For best vibration control, hold the tool as described in *Proper Hand Position* and apply just enough pressure so the damping device on the main handle is approximately mid stroke.

The active vibration control neutralises rebound vibration from the hammer mechanism. Lowering hand and arm vibration, it allows more comfortable use for longer periods of time and extends the life of the unit.

The hammer only needs enough pressure to engage the active vibration control. Applying too much pressure will not make the tool drill or chip faster and active vibration control will not engage.

DeWALT Tool Tag Ready (Fig. A)

Optional Accessory

Your hammer comes with mounting holes **12** and fasteners for installing a DeWALT Tool Tag. You will need a T20 bit tip to install the tag. The DeWALT Tool Tag is designed for tracking and locating professional power tools, equipment, and machines using the DeWALT Tool Connect™ app. For proper installation of the DeWALT Tool Tag refer to the DeWALT Tool Tag manual.

Lock-On Switch (Fig. A)

Chipping mode only

The lock-on switch **8** offers increased comfort in extended use applications. To lock the tool on, depress the lock-on switch while the tool is running. The tool will continue to run after the switch is released. To unlock and turn off the tool, depress and release the switch.

Electronic Speed and Impact Control (Fig. A)

The electronic speed and impact control allows the use of smaller drill bits without the risk of bit breakage, hammerdrilling into light and brittle materials without shattering and optimal tool control for precise chiseling.

To set the electronic speed and impact control dial **9**, turn the dial to the desired level. The higher the number, the greater the speed and impact energy. Dial settings make the tool extremely flexible and adaptable for many different applications. The required setting depends on the bit size and hardness of material being drilled.

- When chiselling or drilling in soft, brittle materials or when minimum break-out is required, set the dial to a low setting;
- When breaking or drilling in harder materials, set the dial to a high setting.

Overload Clutch

In case of jamming of a drill bit, the drive to the drill spindle is interrupted. Because of the resulting forces, always hold the tool with both hands and take a firm stance. After the overload, release and depress the trigger to re-engage drive.

Mechanical Clutch

These tools are fitted with a mechanical clutch. The indication that the clutch has activated will be an audible ratcheting together with increased vibration.



Anti-Rotation System

In addition to the clutch, an anti-rotation system offers increased user comfort through an on-board, anti-rotation technology capable of detecting if the user loses control of the hammer. When a jam is detected, the torque and speed are stopped instantly. This feature prevents self rotation of the tool.

The anti-rotation system indicator **10** will illuminate to indicate status.

Anti-Rotation System and Service Indicator LED (Fig. A)

Your rotary hammer has two LEDs, indicating the Anti-rotation system and a service indicator. Refer to the table for more information on LED functionality.

| LED Function | Description |
|--|---|
|  Red (flashing) | Lock-on/Service The anti-rotation system indicator LED 10 lights up if the lock-on switch 8 is used in any mode except the chipping mode or if there is a fault with the tool or the brushes have completely worn out |
|  Red (permanently on) | Anti-rotation system Anti-rotation system is engaged. |
|  Yellow (permanently on) | Brush Service The yellow brushwear indicator LED 11 lights up when the carbon brushes are nearly worn out, indicating that the tool needs servicing within the next 8 hours of use. |

ASSEMBLY AND ADJUSTMENTS

 **WARNING:** To reduce the risk of serious personal injury, turn tool off and disconnect tool from power source before making any adjustments or removing/installing attachments or accessories. Be sure the

trigger switch is in the OFF position. An accidental start-up can cause injury.

Side Handle (Fig. A, B)

 **WARNING:** To reduce the risk of personal injury, ALWAYS operate the tool with the side handle properly installed. Failure to do so may result in the side handle slipping during tool operation and subsequent loss of control. Hold tool with both hands to maximize control.

The side handle **2** clamps to the front of the gear case and may be rotated 360° to permit right- or left-hand use.

Mounting the Straight Side Handle (Fig. B)

1. Widen the ring opening of the side handle **2** by rotating it anti-clockwise.
2. Slide the assembly onto the nose of the tool, through the steel ring **14** and onto the collar **3**, past the chisel holder and sleeve.
3. Rotate the side handle assembly to the desired position. For hammerdrilling horizontally with a heavy drill bit, place the side handle assembly at an angle of approximately 20° to the tool for optimum control.
4. Lock the side handle mounting assembly in place by securely tightening the handle **2** rotating it clockwise so that the assembly will not rotate.

Bit and Bit Holder

 **WARNING:** Burn Hazard. ALWAYS wear gloves when changing bits. Accessible metal parts on the tool and bits may get extremely hot during operation. Small bits of broken material may damage bare hands.

The hammerdrill can be fitted with different bits depending on the desired application. Use sharp drill bits only.

Inserting and Removing SDS MAX Accessories (Fig. C)

This machine uses SDS MAX bits and chisels (refer to the inset in Figure C for a cross-section of an SDS MAX bit shank).

1. Clean the bit shank.
2. Pull back the locking sleeve **7** and insert the bit shank.
3. Turn the bit slightly until the sleeve snaps into position.
4. Pull on the bit to check if it is properly locked. The hammering function requires the bit to be able to move axially several centimetres when locked in the tool holder.
5. To remove a bit pull back the tool holder locking sleeve **7** and pull the bit out of the bit holder **6**.

OPERATION

Instructions for Use

 **WARNING:** Always observe the safety instructions and applicable regulations.

 **WARNING:** To reduce the risk of serious personal injury, turn tool off and disconnect tool from power source before making any adjustments or removing/installing attachments or accessories. Be sure the

trigger switch is in the OFF position. An accidental start-up can cause injury.

Proper Hand Position (Fig. D)

⚠ WARNING: To reduce the risk of serious personal injury, **ALWAYS** use proper hand position as shown.



⚠ WARNING: To reduce the risk of serious personal injury, **ALWAYS** hold securely in anticipation of a sudden reaction.

Proper hand position requires one hand on the main handle **5**, with the other hand on the side handle **2**.

Operation Modes (Fig. A)

⚠ WARNING: Do not select the operating mode when the tool is running.

Your tool is equipped with a mode selector switch **4** to select the mode appropriate to desired operation.

| Symbol | Mode | Application |
|---|-------------------------|------------------------------------|
|  | Rotary Hammering | Drilling into concrete and masonry |
|  | Hammering only | Light chipping |
|  | Bit Adjustment | Chisel bit position adjustment |

To Select an Operating Mode

- Rotate the mode selector dial so that the arrow points to the symbol corresponding with the desired mode.

NOTE: The mode selector switch **4** must be in rotary drilling, rotary hammering or hammering only mode at all times. There are no operable positions in between. It may be necessary to briefly run the motor after having changed from 'hammering only' to 'rotary' modes in order to align the gears.

Indexing the Chisel Position (Fig. A)

The chisel can be indexed and locked into 24 different positions.

1. Rotate the mode selector switch **4** until it points towards the **0** position.
2. Rotate the chisel in the desired position.
3. Set the mode selector switch **4** to the "hammering only" position.
4. Twist the chisel until it locks in position.

Performing an Application (Fig. A)

⚠ WARNING: TO REDUCE THE RISK OF PERSONAL INJURY, ALWAYS ensure workpiece is anchored or clamped firmly. If drilling thin material, use a wood "backup" block to prevent damage to the material.

⚠ WARNING: Always wait until the motor has come to a complete standstill before changing the direction of rotation.

Switching On and Off (Fig. A)

To turn the tool on, depress the trigger switch **1**.

To stop the tool, release the trigger switch.

Drilling with a Solid Bit (Fig. A)

1. Insert the appropriate drill bit.
2. Set the mode selector switch **4** to the hammerdrilling position.
3. Set the electronic speed and impact control dial **9**.
4. Fit and adjust the side handle **2**.
5. Mark the spot where the hole is to be drilled.
6. Place the drill bit on the spot and switch on the tool.
7. Always switch off the tool when work is finished and before unplugging.

Drilling with a Core Bit (Fig. A)

1. Insert the appropriate core bit.
2. Assemble the centerdrill into the core bit.
3. Set the mode selector switch **4** to the hammerdrilling position.
4. Turn the electronic speed and impact control dial **9** to a medium or high speed setting.
5. Fit and adjust the side handle **2**.
6. Place the centerdrill on the spot and switch on the tool. Drill until the core penetrates into the concrete approximately 1 cm.
7. Stop the tool and remove the centerdrill. Place the core bit back into the hole and continue drilling.
8. When drilling through a structure thicker than the depth of the core bit, break away the round cylinder of concrete or core inside the bit at regular intervals.
To avoid unwanted breaking away of concrete around the hole, first drill a hole the diameter of the centerdrill completely through the structure. Then drill the cored hole halfway from each side.
9. Always turn the tool off when work is finished and before unplugging.

Chipping and Chiselling (Fig. A)

1. Insert the appropriate chisel and rotate it by hand to lock it into one of 24 positions.
2. Set the mode selector switch **4** to the 'hammering only' position.
3. Set the electronic speed and impact control dial **9**.
4. Fit and adjust the side handle **2**.
5. Turn the tool on and start working.
6. Always turn the tool off when work is finished and before unplugging.

MAINTENANCE

Your DEWALT power tool has been designed to operate over a long period of time with a minimum of maintenance. Continuous satisfactory operation depends upon proper tool care and regular cleaning.

⚠ WARNING: To reduce the risk of serious personal injury, turn tool off and disconnect tool from power source before making any adjustments or removing/installing attachments or accessories. Be sure the trigger switch is in the OFF position. An accidental start-up can cause injury.



Lubrication

Your power tool requires no additional lubrication.



Cleaning



WARNING: Blow dirt and dust out of the main housing with dry air as often as dirt is seen collecting in and around the air vents. Wear approved eye protection and approved dust mask when performing this procedure.



WARNING: Never use solvents or other harsh chemicals for cleaning the non-metallic parts of the tool. These chemicals may weaken the materials used in these parts. Use a cloth dampened only with water and mild soap. Never let any liquid get inside the tool; never immerse any part of the tool into a liquid.

Optional Accessories



WARNING: Since accessories, other than those offered by DEWALT, have not been tested with this product, use of such accessories with this tool could be hazardous. To reduce the risk of injury, only DEWALT recommended accessories should be used with this product.

Various types of SDS MAX drill bits and chisels are available as an option. Accessories and attachments used must be regularly lubricated around the SDS MAX fitment.

Consult your dealer for further information on the appropriate accessories.

Protecting the Environment



Separate collection. Products and batteries marked with this symbol must not be disposed of with normal household waste.

Products and batteries contain materials that can be recovered or recycled reducing the demand for raw materials. Please recycle electrical products and batteries according to local provisions. Further information is available at www.2helpU.com.

