

# DEWALT®

МАГАЗИН  
БАШ МАЙСТОРА®  
ПРОФЕСИОНАЛНИ РЕШЕНИЯ



[www.DEWALT.com](http://www.DEWALT.com)

**DWE7492**



МАГАЗИН  
**БАШ МАЙСТОРА**<sup>®</sup>  
ПРОФЕСИОНАЛНИ РЕШЕНИЯ

Fig. A

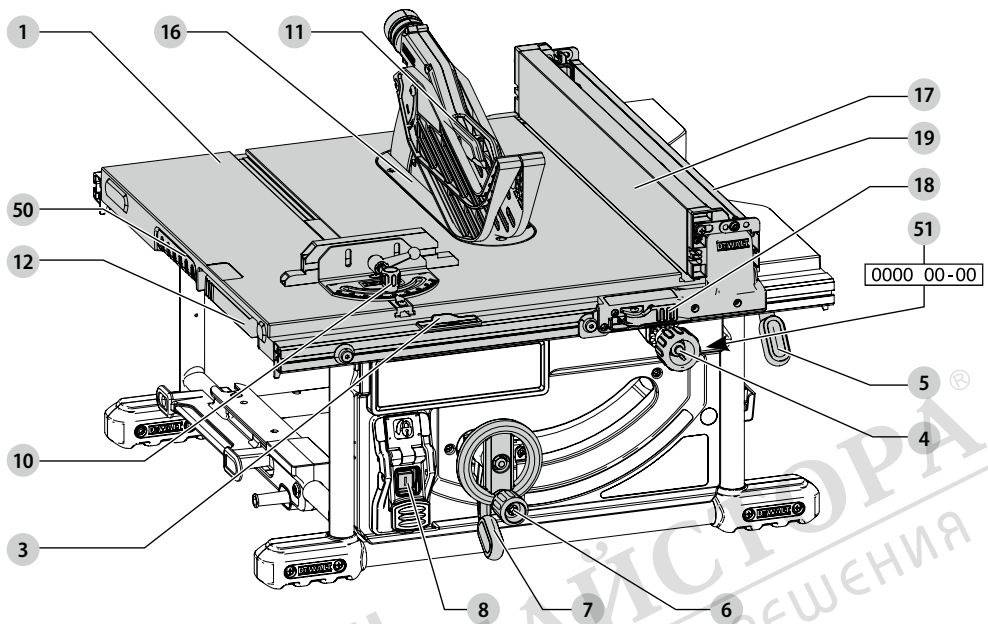

Fig. B

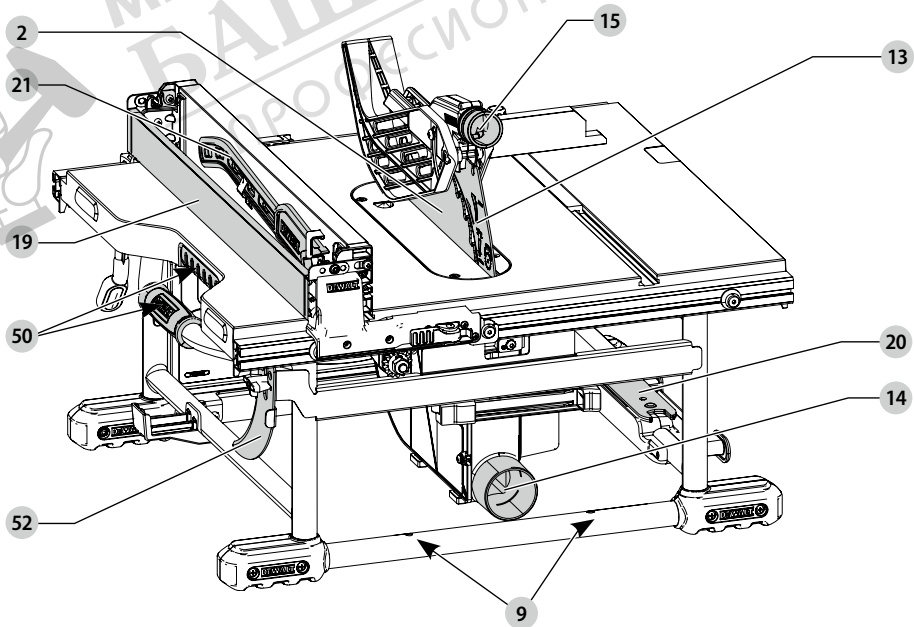

Fig. C

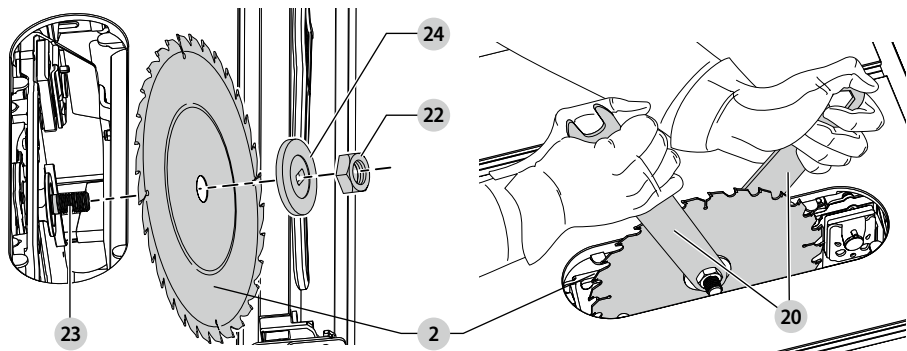

Fig. D

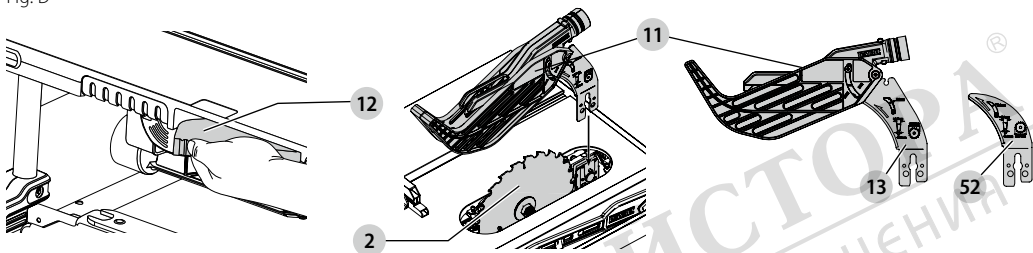

Fig. E

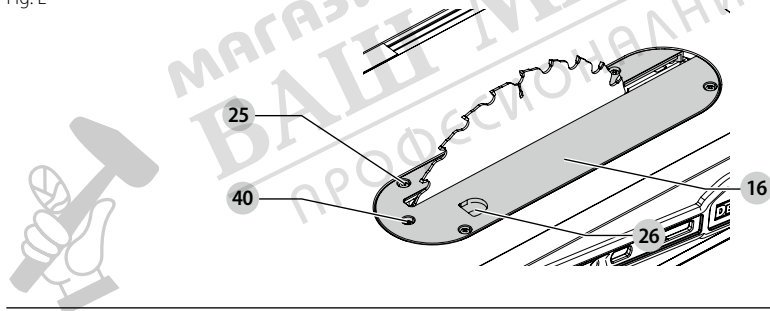

Fig. F

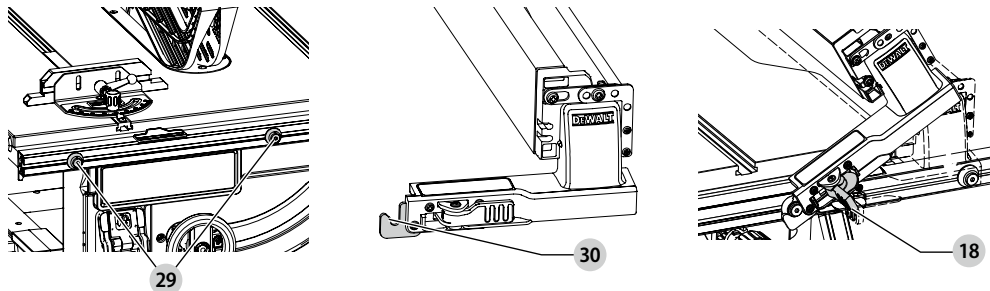

Fig. G

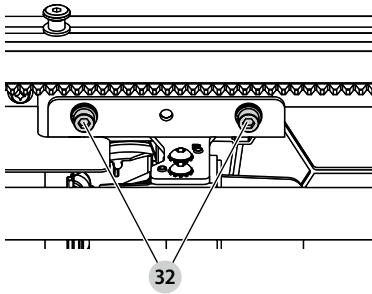

Fig. H

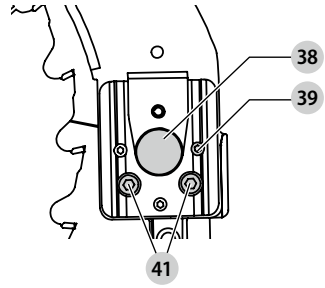
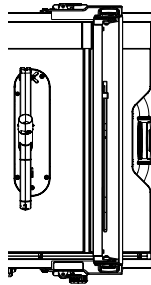
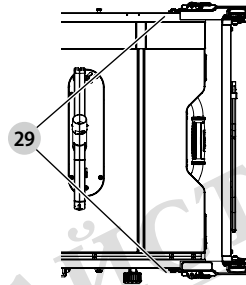

Fig. I



Position 1



Position 2

Fig. J

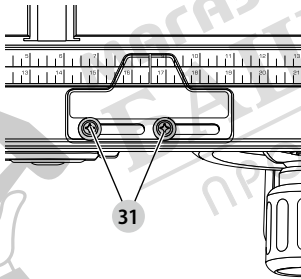

Fig. K

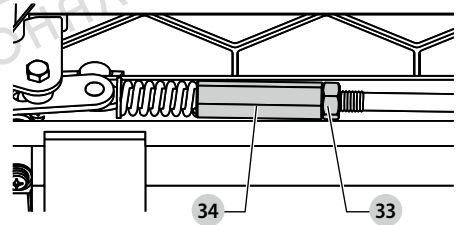

Fig. L

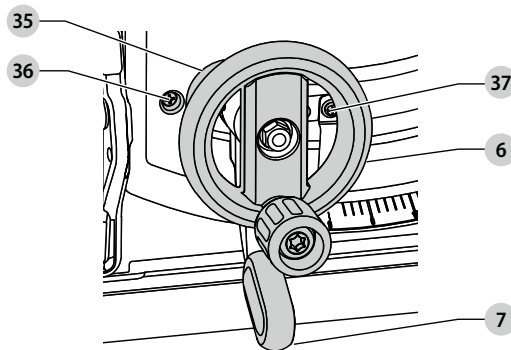

Fig. M

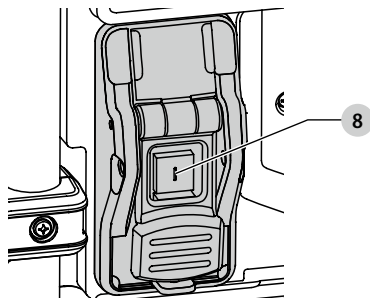

Fig. N

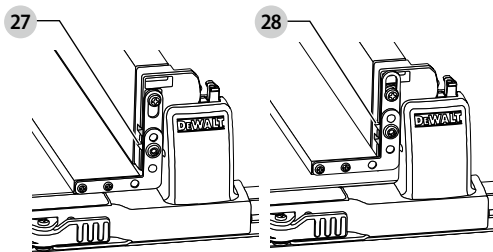

Fig. O

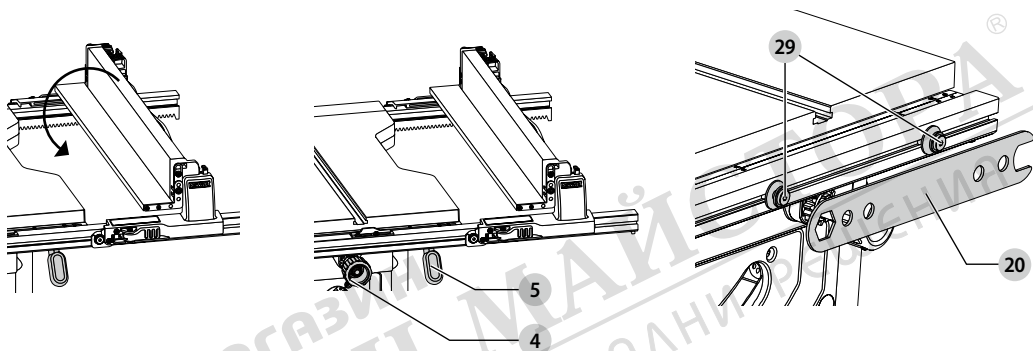

Fig. P

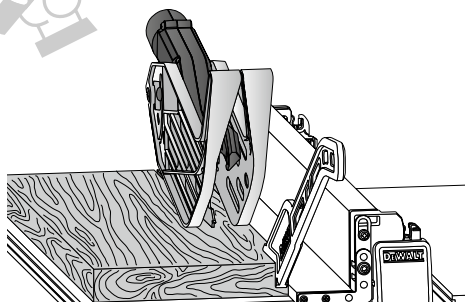

Fig. Q

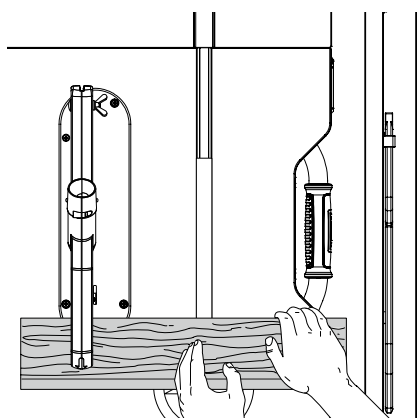

Fig. R

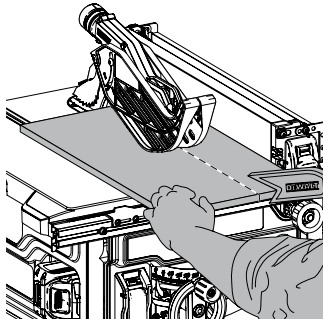

Fig. S

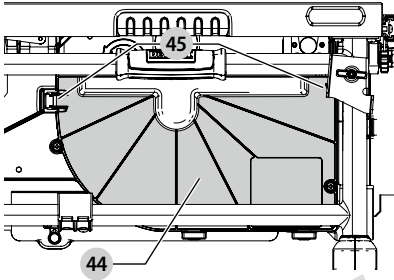

Fig. T

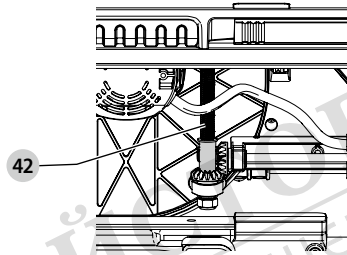

Fig. U

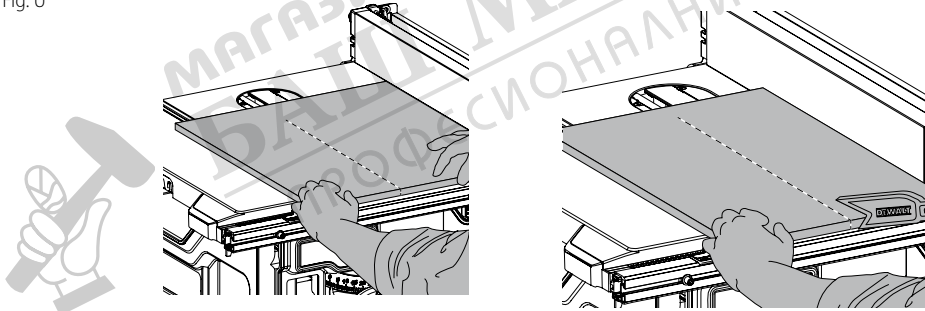

Fig. V

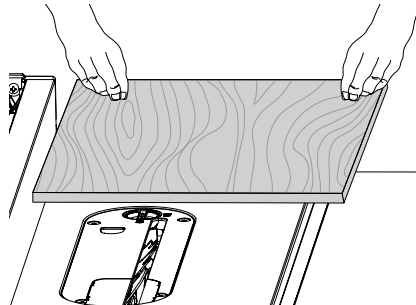

Fig. W

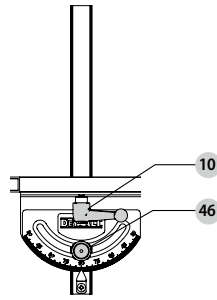
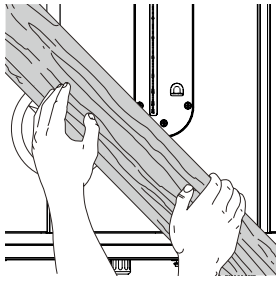

Fig. X

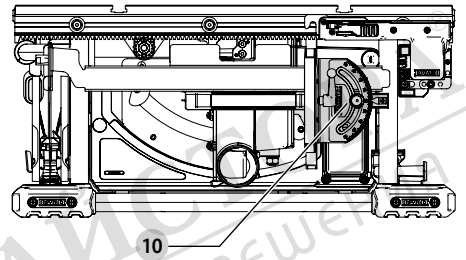
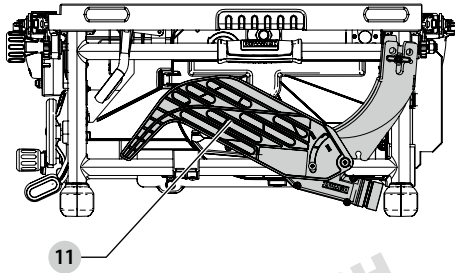

Fig. Y

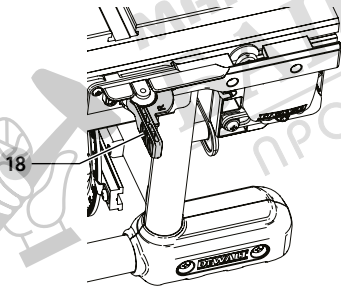

Fig. Z

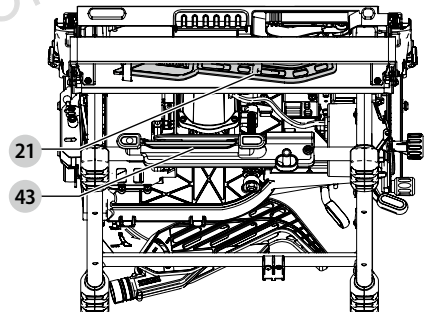
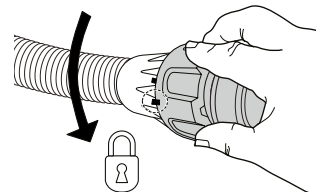
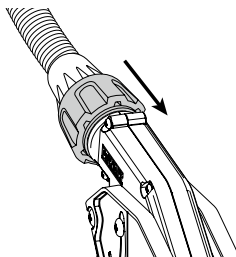
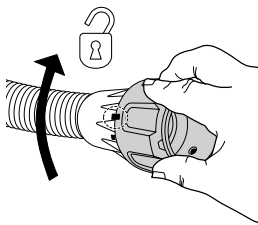

Fig. AA





# TABLE SAW

## DWE7492

### Congratulations!

You have chosen a DEWALT tool. Years of experience, thorough product development and innovation make DEWALT one of the most reliable partners for professional power tool users.

### Technical Data

		DWE7492-GB	DWE7492-LX
Voltage	V <sub>AC</sub>	230	115
Type		2	1
Motor power (input)	W	2000	1700
Motor power (output)	W	1200	800
No load speed	min <sup>-1</sup>	4800	4800
Blade diameter	mm	250	250
Blade bore	mm	30	30
Blade body thickness	mm	2.0	2.0
Riving knife thickness	mm	2.3	2.3
Depth of cut at 90°	mm	77	77
Depth of cut at 45°	mm	55	55
Bevel angle	°	45–90	45–90
Maximum bevel angle	°	45–90	45–90
Mitre angle	°	30–90	30–90
Ripping capacity	mm	825	825
Overall dimensions	mm	680 x 650 x 330	680 x 650 x 330
Weight	kg	26.5	26.5
Noise values values (triaux vector sum) according to EN62841-3-1:			
L <sub>PA</sub> (emission sound pressure level)	dB(A)	92.0	92.0
L <sub>WA</sub> (sound power level)	dB(A)	105.2	105.2
K (uncertainty for the given sound level)	dB(A)	2	2

The vibration and/or noise emission level given in this information sheet has been measured in accordance with a standardised test given in EN62841 and may be used to compare one tool with another. It may be used for a preliminary assessment of exposure.



**WARNING:** The declared vibration and/or noise emission level represents the main applications of the tool. However if the tool is used for different applications, with different accessories or poorly maintained, the vibration and/or noise emission may differ. This may significantly increase the exposure level over the total working period.

An estimation of the level of exposure to vibration and/or noise should also take into account the times when the tool is switched off or when it is running but not actually

doing the job. This may significantly reduce the exposure level over the total working period.

Identify additional safety measures to protect the operator from the effects of vibration and/or noise such as: maintain the tool and the accessories, keep the hands warm (relevant for vibration), organisation of work patterns.

### EC-Declaration of Conformity

#### Machinery Directive



#### Table Saw DWE7492

DEWALT declares that these products described under **Technical Data** are in compliance with:

2006/42/EC, EN62841-1:2015 + AC:2015, EN62841-3-1:2014 + AC:2015 + A11:2017.

These products also comply with Directive 2014/30/EU and 2011/65/EU. For more information, please contact DEWALT at the following address or refer to the back of the manual.

The undersigned is responsible for compilation of the technical file and makes this declaration on behalf of DEWALT.

Markus Rompel  
Vice President of Engineering, PTE-Europe  
DEWALT, Richard-Klinger-Straße 11,  
D-65510, Idstein, Germany  
10.01.2022



**WARNING:** To reduce the risk of injury, read the instruction manual.

### DECLARATION OF CONFORMITY THE SUPPLY OF MACHINERY (SAFETY) REGULATIONS 2008



#### Table Saw DWE7492

DEWALT declares that these products described under **Technical Data** are in compliance with:

The Supply of Machinery (Safety) Regulations, 2008, S.I. 2008/1597 (as amended), EN62841-1:2015 + AC:2015, EN62841-3-1:2014 + AC:2015 + A11:2017

These products conform to the following UK Regulations:  
Electromagnetic Compatibility Regulations, 2016, S.I.2016/1091  
(as amended).

The Restriction of the Use of Certain Hazardous Substances  
in Electrical and Electronic Equipment Regulations 2012, S.I.  
2012/3032 (as amended).

For more information, please contact DEWALT at the following  
address or refer to the back of the manual.

The undersigned is responsible for compilation of the technical  
file and makes this declaration on behalf of DEWALT.



Karl Evans  
Vice President Professional Power Tools EANZ GTS  
DEWALT UK, 270 Bath Road, Slough  
Berkshire, SL1 4DX  
England  
10.01.2022

## Definitions: Safety Guidelines

The definitions below describe the level of severity for each  
signal word. Please read the manual and pay attention to  
these symbols.



**DANGER:** Indicates an imminently hazardous  
situation which, if not avoided, **will** result in **death or  
serious injury**.



**WARNING:** Indicates a potentially hazardous situation  
which, if not avoided, **could** result in **death or  
serious injury**.



**CAUTION:** Indicates a potentially hazardous situation  
which, if not avoided, **may** result in **minor or  
moderate injury**.

**NOTICE:** Indicates a practice **not related to  
personal injury** which, if not avoided, **may** result in  
**property damage**.



Denotes risk of electric shock.



Denotes risk of fire.

## General Power Tool Safety Warnings



**WARNING:** Read all safety warnings, instructions,  
illustrations and specifications provided with this  
power tool. Failure to follow all instructions listed below  
may result in electric shock, fire and/or serious injury.

### SAVE ALL WARNINGS AND INSTRUCTIONS FOR FUTURE REFERENCE

The term "power tool" in the warnings refers to your mains-  
operated (corded) power tool or battery-operated (cordless)  
power tool.

## 1) Work area safety

- a) **Keep work area clean and well lit.** Cluttered or dark areas invite accidents.
- b) **Do not operate power tools in explosive atmospheres, such as in the presence of flammable liquids, gases or dust.** Power tools create sparks which may ignite the dust or fumes.
- c) **Keep children and bystanders away while operating a power tool.** Distractions can cause you to lose control.

## 2) Electrical safety

- a) **Power tool plugs must match the outlet. Never modify the plug in any way. Do not use any adapter plugs with earthed (grounded) power tools.** Unmodified plugs and matching outlets will reduce risk of electric shock.
- b) **Avoid body contact with earthed or grounded surfaces such as pipes, radiators, ranges and refrigerators.** There is an increased risk of electric shock if your body is earthed or grounded.
- c) **Do not expose power tools to rain or wet conditions.** Water entering a power tool will increase the risk of electric shock.
- d) **Do not abuse the cord. Never use the cord for carrying, pulling or unplugging the power tool. Keep cord away from heat, oil, sharp edges or moving parts.** Damaged or entangled cords increase the risk of electric shock.
- e) **When operating a power tool outdoors, use an extension cord suitable for outdoor use.** Use of a cord suitable for outdoor use reduces the risk of electric shock.
- f) **If operating a power tool in a damp location is unavoidable, use a residual current device (RCD) protected supply.** Use of an RCD reduces the risk of electric shock.

## 3) Personal safety

- a) **Stay alert, watch what you are doing and use common sense when operating a power tool. Do not use a power tool while you are tired or under the influence of drugs, alcohol or medication.** A moment of inattention while operating power tools may result in serious personal injury.
- b) **Use personal protective equipment. Always wear eye protection.** Protective equipment such as dust mask, non-skid safety shoes, hard hat, or hearing protection used for appropriate conditions will reduce personal injuries.
- c) **Prevent unintentional starting. Ensure the switch is in the off position before connecting to power source and/or battery pack, picking up or carrying the tool.** Carrying power tools with your finger on the switch or energising power tools that have the switch on invites accidents.
- d) **Remove any adjusting key or wrench before turning the power tool on.** A wrench or a key left attached to a rotating part of the power tool may result in personal injury.

- e) **Do not overreach. Keep proper footing and balance at all times.** This enables better control of the power tool in unexpected situations.
- f) **Dress properly. Do not wear loose clothing or jewellery. Keep your hair, clothing and gloves away from moving parts.** Loose clothes, jewellery or long hair can be caught in moving parts.
- g) **If devices are provided for the connection of dust extraction and collection facilities, ensure these are connected and properly used.** Use of dust collection can reduce dust-related hazards.
- h) **Do not let familiarity gained from frequent use of tools allow you to become complacent and ignore tool safety principles.** A careless action can cause severe injury within a fraction of a second.

#### 4) Power tool use and care

- a) **Do not force the power tool. Use the correct power tool for your application.** The correct power tool will do the job better and safer at the rate for which it was designed.
- b) **Do not use the power tool if the switch does not turn it on and off.** Any power tool that cannot be controlled with the switch is dangerous and must be repaired.
- c) **Disconnect the plug from the power source and/or remove the battery pack, if detachable, from the power tool before making any adjustments, changing accessories, or storing power tools.** Such preventive safety measures reduce the risk of starting the power tool accidentally.
- d) **Store idle power tools out of the reach of children and do not allow persons unfamiliar with the power tool or these instructions to operate the power tool.** Power tools are dangerous in the hands of untrained users.
- e) **Maintain power tools and accessories. Check for misalignment or binding of moving parts, breakage of parts and any other condition that may affect the power tool's operation. If damaged, have the power tool repaired before use.** Many accidents are caused by poorly maintained power tools.
- f) **Keep cutting tools sharp and clean.** Properly maintained cutting tools with sharp cutting edges are less likely to bind and are easier to control.
- g) **Use the power tool, accessories and tool bits etc., in accordance with these instructions taking into account the working conditions and the work to be performed.** Use of the power tool for operations different from those intended could result in a hazardous situation.
- h) **Keep handles and grasping surfaces dry, clean and free from oil and grease.** Slippery handles and grasping surfaces do not allow for safe handling and control of the tool in unexpected situations.

#### 5) Service

- a) **Have your power tool serviced by a qualified repair person using only identical replacement parts.** This will ensure that the safety of the power tool is maintained.

## Safety Instructions for Table Saws

### 1) Guarding Related Warnings

- a) **Keep guards in place. Guards must be in working order and be properly mounted.** A guard that is loose, damaged, or is not functioning correctly must be repaired or replaced.
- b) **Always use saw blade guard, riving knife and anti-kickback pawls for every through-cutting operation.** For through-cutting operations where the saw blade cuts completely through the thickness of the workpiece, the guard and other safety devices help reduce the risk of injury.
- c) **Immediately reattach the guarding system after completing an operation (such as rabbeting cuts) which requires removal of the guard, riving knife and/or anti-kickback device.** The guard, riving knife, and anti-kickback device help to reduce the risk of injury.
- d) **Make sure the saw blade is not contacting the guard, riving knife or the workpiece before the switch is turned on.** Inadvertent contact of these items with the saw blade could cause a hazardous condition.
- e) **Adjust the riving knife as described in this instruction manual.** Incorrect spacing, positioning and alignment can make the riving knife ineffective in reducing the likelihood of kickback.
- f) **For the riving knife and anti-kickback pawls to work, they must be engaged in the workpiece.** The riving knife and anti-kickback pawls are ineffective when cutting workpieces that are too short to be engaged with the riving knife and anti-kickback pawls. Under these conditions a kickback cannot be prevented by the riving knife and anti-kickback pawls.
- g) **Use the appropriate saw blade for the riving knife.** For the riving knife to function properly, the saw blade diameter must match the appropriate riving knife and the body of the saw blade must be thinner than the thickness of the riving knife and the cutting width of the saw blade must be wider than the thickness of the riving knife.

### 2) Cutting Procedures Warnings

- a)  **DANGER: Never place your fingers or hands in the vicinity or in line with the saw blade.** A moment of inattention or a slip could direct your hand towards the saw blade and result in serious personal injury.
- b) **Feed the workpiece into the saw blade or cutter only against the direction of rotation.** Feeding the workpiece in the same direction that the saw blade is rotating above the table may result in the workpiece, and your hand, being pulled into the saw blade.
- c) **Never use the mitre gauge to feed the workpiece when ripping and do not use the rip fence as a length stop when cross cutting with the mitre gauge.** Guiding the workpiece with the rip fence and the mitre gauge at the same time increases the likelihood of saw blade binding and kickback.

- d) **When ripping, always apply the workpiece feeding force between the fence and the saw blade. Use a push stick when the distance between the fence and the saw blade is less than 150 mm, and use a push block when this distance is less than 50 mm.** "Work helping" devices will keep your hand at a safe distance from the saw blade.
- e) **Use only the push stick provided by the manufacturer or constructed in accordance with the instructions.** This push stick provides sufficient distance of the hand from the saw blade.
- f) **Never use a damaged or cut push stick.** A damaged push stick may break causing your hand to slip into the saw blade.
- g) **Do not perform any operation "freehand". Always use either the rip fence or the mitre gauge to position and guide the workpiece.** "Freehand" means using your hands to support or guide the workpiece, in lieu of a rip fence or mitre gauge. Freehand sawing leads to misalignment, binding and kickback.
- h) **Never reach around or over a rotating saw blade.** Reaching for a workpiece may lead to accidental contact with the moving saw blade.
- i) **Provide auxiliary workpiece support to the rear and/or sides of the saw table for long and/or wide workpieces to keep them level.** A long and/or wide workpiece has a tendency to pivot on the table's edge, causing loss of control, saw blade binding and kickback.
- j) **Feed workpiece at an even pace. Do not bend or twist the workpiece. If jamming occurs, turn the tool off immediately, unplug the tool then clear the jam.** Jamming the saw blade by the workpiece can cause kickback or stall the motor.
- k) **Do not remove pieces of cut-off material while the saw is running.** The material may become trapped between the fence or inside the saw blade guard and the saw blade pulling your fingers into the saw blade. Turn the saw off and wait until the saw blade stops before removing material.
- l) **Use an auxiliary fence in contact with the table top when ripping workpieces less than 2 mm thick.** A thin workpiece may wedge under the rip fence and create a kickback.
- the saw blade as the fence.** Kickback may propel the workpiece at high velocity towards anyone standing in front and in line with the saw blade.
- b) **Never reach over or in back of the saw blade to pull or to support the workpiece.** Accidental contact with the saw blade may occur or kickback may drag your fingers into the saw blade.
- c) **Never hold and press the workpiece that is being cut off against the rotating saw blade.** Pressing the workpiece being cut off against the saw blade will create a binding condition and kickback.
- d) **Align the fence to be parallel with the saw blade.** A misaligned fence will pinch the workpiece against the saw blade and create kickback.
- e) **Use a featherboard to guide the workpiece against the table and fence when making non-through cuts such as rabbeting cuts.** A featherboard helps to control the workpiece in the event of a kickback.
- f) **Support large panels to minimise the risk of saw blade pinching and kickback.** Large panels tend to sag under their own weight. Support(s) must be placed under all portions of the panel overhanging the table top.
- g) **Use extra caution when cutting a workpiece that is twisted, knotted, warped or does not have a straight edge to guide it with a mitre gauge or along the fence.** A warped, knotted, or twisted workpiece is unstable and causes misalignment of the kerf with the saw blade, binding and kickback.
- h) **Never cut more than one workpiece, stacked vertically or horizontally.** The saw blade could pick up one or more pieces and cause kickback.
- i) **When restarting the saw with the saw blade in the workpiece, centre the saw blade in the kerf so that the saw teeth are not engaged in the material.** If the saw blade binds, it may lift up the workpiece and cause kickback when the saw is restarted.
- j) **Keep saw blades clean, sharp, and with sufficient set. Never use warped saw blades or saw blades with cracked or broken teeth.** Sharp and properly set saw blades minimise binding, stalling and kickback.

#### 4) Table Saw Operating Procedure Warnings

- a) **Turn off the table saw and disconnect from the power source when removing the table insert, changing the saw blade or making adjustments to the riving knife, anti-kickback pawls or saw blade guard, and when the machine is left unattended.** Precautionary measures will avoid accidents.
- b) **Never leave the table saw running unattended. Turn it off and don't leave the tool until it comes to a complete stop.** An unattended running saw is an uncontrolled hazard.
- c) **Locate the table saw in a well-lit and level area where you can maintain good footing and balance. It should be installed in an area that provides enough room to easily handle the size of your**

### 3) Kickback Causes and Related Warnings

Kickback is a sudden reaction of the workpiece due to a pinched, jammed saw blade or misaligned line of cut in the workpiece with respect to the saw blade or when a part of the workpiece binds between the saw blade and the rip fence or other fixed object.

Most frequently during kickback, the workpiece is lifted from the table by the rear portion of the saw blade and is propelled towards the operator.

Kickback is the result of saw misuse and/or incorrect operating procedures or conditions and can be avoided by taking proper precautions as given below.

- a) **Never stand directly in line with the saw blade. Always position your body on the same side of**

**workpiece.** Cramped, dark areas, and uneven slippery floors invite accidents.

- d) **Frequently clean and remove sawdust from under the saw table and/or the dust collection device.**  
Accumulated sawdust is combustible and may self-ignite.
- e) **The table saw must be secured.** A table saw that is not properly secured may move or tip over.
- f) **Remove tools, wood scraps, etc. from the table before the table saw is turned on.** Distraction or a potential jam can be dangerous.
- g) **Always use saw blades with correct size and shape (diamond versus round) of arbour holes.** Saw blades that do not match the mounting hardware of the saw will run off-centre, causing loss of control.
- h) **Never use damaged or incorrect saw blade mounting means such as flanges, saw blade washers, bolts or nuts.** These mounting means were specially designed for your saw, for safe operation and optimum performance.
- i) **Never stand on the table saw, do not use it as a stepping stool.** Serious injury could occur if the tool is tipped or if the cutting tool is accidentally contacted.
- j) **Make sure that the saw blade is installed to rotate in the proper direction. Do not use grinding wheels, wire brushes, or abrasive wheels on a table saw.** Improper saw blade installation or use of accessories not recommended may cause serious injury.

## Additional Safety Rules for Table Saws



**WARNING:** Cutting plastics, sap coated wood, and other materials may cause melted material to accumulate on the blade tips and the body of the saw blade, increasing the risk of blade overheating and binding while cutting.

- **Avoid awkward positions, where a sudden slip could cause a hand to move into a saw blade.**
- **Do not attempt to retrieve materials near the blade on the saw table while the blade is spinning.**
- **Never reach in back of, or around, the cutting tool with either hand to hold down the workpiece.**
- **Keep arms, hands and fingers away from the blade to prevent serious injury.**
- **Use a push stick that is appropriate to the application to push workpieces through the saw.** A push stick is a wooden or plastic stick, often homemade, that should be used whenever the size or shape of the workpiece would cause you to place your hands within 152 mm of the blade.
- **Use hold-downs, jigs, fixtures or feather boards to help guide and control the workpiece.** Accessories for use with your tool are available at extra cost from your local dealer or authorized service centre.
- **Do not perform ripping, crosscutting or any other operation freehand.**
- **Never reach around or over saw blade while the blade is spinning.**
- **Stability.** Make sure the table saw is firmly mounted to a secure surface before use and does not move.
- **The table saw should only be set up on a level and stable surface.** The work area should be free from obstructions and trip hazards. No materials or tools should be leaned against the saw.
- **Never cut metals, cement board or masonry.** Certain man-made materials have special instructions for cutting on table saws. Follow the manufacturer's recommendations at all times. Damage to the saw and personal injury may result.
- **Do not install a diamond masonry blade and attempt to use the table saw as a wet saw.**
- **The proper throat plate must be locked in place at all times to reduce the risk of a thrown workpiece and possible injury.**
- **Wear gloves when handling saw blades.**
- **Use the correct saw blade for the intended operation.** The blade must rotate toward the front of the saw. Always tighten the blade arbor nut securely. Before use, inspect the blade for cracks or missing teeth. Do not use a damaged or dull blade.
- **Never attempt to free a stalled saw blade without first turning the machine off and disconnect tool from power source.** If a workpiece or cut-off piece becomes trapped inside the blade guard assembly, turn saw off and wait for blade to stop before lifting the blade guard assembly and removing the piece.
- **Never start the machine with the workpiece against the blade to reduce the risk of a thrown workpiece and personal injury.**
- **Do not have any part of your body in line with the blade.** Personal injury may occur. Stand to either side of the blade.
- **Never perform layout, assembly or set-up work on the table/work area when the machine is running.** A sudden slip could cause a hand to move into the blade. Severe injury can result.
- **Never perform any adjustments while the saw is running such as fence repositioning or removal, bevel lock adjustment, or blade height adjustment.**
- **Clean the table/work area before leaving the machine.** Lock the switch in the "OFF" position and disconnect tool from power source to prevent unauthorized use.
- **Always lock the fence and bevel adjustment before cutting.**
- **Avoid overheating the saw blade tips.** Keep material moving and parallel with the fence. Do not force work into the blade.
- **If cutting plastic materials, avoid melting the plastic.**
- **Do not leave a long board (or other workpiece) unsupported so the spring of the board causes it to shift on the table resulting in loss of control and possible injury.** Provide proper support for the workpiece, based on its size and the type of operation to be performed. Hold the work firmly against the fence and down against the table surface.
- **If this saw makes an unfamiliar noise or if it vibrates excessively, cease operating immediately, turn unit**

**off and disconnect tool from power source until the problem has been located and corrected.** Contact a DEWALT factory service centre, a DEWALT authorized service centre or other qualified service personnel if the problem can not be found.

- **Do not operate this machine until it is completely assembled and installed according to the instructions.** A machine incorrectly assembled can cause serious injury.
- **Never attempt to cut a stack of loose pieces of material which could cause loss of control or kickback.** Support all materials securely.

## Saw Blades



**WARNING:** to minimise the risk of kickback and to ensure proper cutting, the splitter and riving knife must be the proper thickness for the blade used. If a different blade is used, check the blade body (plate) thickness and the blade kerf (cutting) width marked on the blade or on the blade packaging. The splitter and riving knife thickness must be greater than the body thickness and less than the kerf width.

- Do not use saw blades that do not conform to the dimensions stated in the **Technical Data**. Do not use any spacers to make a blade fit onto the spindle. Use only the blades specified in this manual, complying with EN847-1, if intended for wood and similar materials.
- Consider applying specially designed noise-reduction blades.
- Do not use high steel (HS) saw blades.
- Do not use cracked or damaged saw blades.
- Ensure that the chosen saw blade is suitable for the material to be cut.
- Always wear gloves for handling saw blades and rough material. Saw blades should be carried in a holder wherever practicable.

## Residual risks

The following risks are inherent to the use of saws:

- Injuries caused by touching the rotating parts
- In spite of the application of the relevant safety regulations and the implementation of safety devices, certain residual risks cannot be avoided. These are:
- Impairment of hearing.
  - Risk of accidents caused by the uncovered parts of the rotating saw blade.
  - Risk of injury when changing the saw blade with unprotected hands.
  - Risk of squeezing fingers when opening the guards.
  - Health hazards caused by breathing dust developed when sawing wood, especially oak, beech and MDF.

The following factors are of influence to noise production:

- the material to be cut
- the type of saw blade
- the feed force
- machine maintenance

The following factors are of influence to dust exposure:

- worn saw blade
- dust extractor with air velocity less than 20 m/s
- workpiece not exactly guided

## Electrical Safety

The electric motor has been designed for one voltage only. Always check that the power supply corresponds to the voltage on the rating plate.



Your DEWALT tool is double insulated in accordance with EN60745; therefore no earth wire is required.



**WARNING:** 115 V units have to be operated via a fail-safe isolating transformer with an earth screen between the primary and secondary winding.

If the supply cord is damaged, it must be replaced only by DEWALT or an authorised service organisation.

**NOTE:** This device is intended for the connection to a power supply system with maximum permissible system impedance  $Z_{max}$  of 0.28  $\Omega$  at the interface point (power service box) of user's supply. The user has to ensure that this device is connected only to a power system which fulfills the requirement above. If necessary, the user can ask the public power supply company for the system impedance at the interface point.

## Mains Plug Replacement (U.K. & Ireland Only)

If a new mains plug needs to be fitted:

- Safely dispose of the old plug.
- Connect the brown lead to the live terminal in the plug.
- Connect the blue lead to the neutral terminal.



**WARNING:** No connection is to be made to the earth terminal.

Follow the fitting instructions supplied with good quality plugs. Recommended fuse: 13 A.

## Using an Extension Cable

If an extension cable is required, use an approved 3-core extension cable suitable for the power input of this tool (see **Technical Data**). The minimum conductor size is 1.5 mm<sup>2</sup>; the maximum length is 30 m.

When using a cable reel, always unwind the cable completely.

## Package Contents

The package contains:

- 1 Partly assembled machine
- 1 Rip fence
- 1 Mitre gauge
- 1 Saw blade
- 1 Upper blade guard assembly
- 1 Throat plate
- 2 Blade wrenches
- 1 Push Stick
- 1 Dust extraction adapter
- 1 Instruction manual

- Check for damage to the tool, parts or accessories which may have occurred during transport.
- Take the time to thoroughly read and understand this manual prior to operation.

## Markings on Tool

The following pictograms are shown on the tool:



Read instruction manual before use.



Wear ear protection.



Wear eye protection.



Wear respiratory protection.



Keep hands away from cutting area and the blade.



Riving knife or splitter thickness



Saw blade body thickness and kerf width



Saw blade diameter



Blade guard release lever



Lock/unlock cover at the main switch.



Unplug saw before changing blade



Protect the supply cord/plug against humidity and sharp edges of saw blade

## Date Code Position (Fig. A)

The Date Code **51**, which also includes the year of manufacture, is printed into the housing.

Example:

2022 XX XX

Year of Manufacture

## Description (Fig. A, B)

- WARNING:** Never modify the power tool or any part of it. Damage or personal injury could result.

- 1 Table
- 2 Blade
- 3 Rip scale indicator
- 4 Fine adjust knob
- 5 Rail lock lever
- 6 Blade height adjustment wheel
- 7 Bevel lock lever
- 8 ON/OFF switch
- 9 Mounting holes
- 10 Mitre gauge
- 11 Blade guard assembly
- 12 Blade guard release lever
- 13 Splitter
- 14 Dust exhaust port
- 15 Guard dust exhaust port
- 16 Throat plate
- 17 Rip fence
- 18 Rip fence latch
- 19 Work support/narrow rip fence (shown in stored position)
- 20 Blade wrenches
- 21 Push stick (shown in stored position)
- 50 Carrying handles
- 52 Non-through cutting riving knife (shown in storage position)

## Intended Use

DWE7492 table saw is designed for professional ripping, cross-cutting, mitreing and bevelling with various materials as wood, wood composite materials and plastics.

**DO NOT** use under wet conditions or in the presence of flammable liquids or gases.

**DO NOT** use for cutting metal, cement board, or masonry.

**DO NOT** use shaping cutter heads on this saw.

**DO NOT** perform tapered cuts without a tapered jig accessory.

**DO NOT** use the saw for plunge or cove cutting.

These table saws are professional power tools.

**DO NOT** let children come into contact with the tool.

Supervision is required when inexperienced operators use this tool.

- **Young children and the infirm.** This appliance is not intended for use by young children or infirm persons without supervision. This product is not intended for use by persons (including children) suffering from diminished physical, sensory or mental abilities; lack of experience, knowledge or skills unless they are supervised by a person responsible for their safety. Children should never be left alone with this product.

## ASSEMBLY



**WARNING:** To reduce the risk of serious personal injury, turn tool off and disconnect tool from power source before making any adjustments or removing/installing attachments or accessories. An accidental start-up can cause injury.

## Unpacking

- Remove the saw from the packaging material carefully.
- The machine is fully assembled except for the rip fence, blade guard assembly, mitre gauge, blade wrenches, and dust extraction reducer port.
- Finalize the assembly following the instructions as described below.

 **WARNING:** Always keep the push stick in its place when not in use.

## Mounting the Saw Blade (Fig. A, C)

 **WARNING:** To reduce the risk of injury, turn unit off and disconnect machine from power source before installing and removing accessories, before adjusting or changing set-ups or when making repairs. An accidental start-up can cause injury.

 **WARNING:** When mounting the saw blade, wear protective gloves. The teeth of the saw blades are very sharp and can be dangerous.

 **WARNING:** The saw blade **MUST** be replaced as described in this section. **ONLY** use saw blades as specified under **Technical Data**. We suggest DT4226. **NEVER** fit other saw blades.

 **WARNING:** Do not touch the saw blade after working before it has cooled. The saw blade becomes very hot while working.

**NOTE:** This tool has blade installed from factory.

1. Raise the saw blade arbor to its maximum height by turning the blade height adjustment wheel **6** clockwise.
2. Remove the throat plate **16**. Refer to **Mounting the Throat Plate**.
3. Using wrenches **20**, loosen and remove the arbor nut **22** and flange **24** from the saw arbor by turning anti-clockwise.
4. Place the saw blade on to the spindle **23** making sure the teeth of the blade **2** point down at the front of the table. Assemble the washers and arbor nut to the spindle and tighten arbor nut **22** as far as possible by hand, making sure that the saw blade is against the inner washer and the outer flange **24** is against the blade. Ensure the largest diameter of the flange is against the blade. Ensure the spindle and washers are free from dust and debris.
5. To keep the spindle from rotating when tightening the arbor nut, use the open end of the blade wrench **20** to secure the spindle.
6. Using the arbor wrench, tighten the arbor nut **22** by turning it clockwise.
7. Replace the throat plate.

 **WARNING:** Always check the rip fence pointer and the blade guard assembly after having changed the blade.

## Mounting the Blade Guard Assembly/ Riving Knife (Fig. A, D)

 **WARNING:** Use the guard assembly for all through cutting.

 **WARNING:** Use the riving knife for non-through-cutting when blade guard assembly cannot be used.

 **WARNING:** Do not insert both the blade guard assembly and the non-through-cutting riving knife into the clamp at the same time.

**NOTE:** The saw is shipped with the non-through-cutting riving knife installed.

1. Raise the saw blade arbor to its maximum height.
2. Install blade guard assembly by pulling the guard release lever **12** and inserting either the non-through-cutting riving knife **52** or the blade guard assembly **11** until it bottoms out.
3. Release lever, make sure clamp plates are fully closed and clamp the splitter securely.

 **WARNING:** Before connecting the table saw to the power source or operating the saw, always inspect the blade guard assembly for proper alignment and clearance with saw blade. Check alignment after each change of bevel angle.

 **WARNING:** To reduce the risk of serious personal injury, **DO NOT** operate saw if blade assembly is not securely clamped in place.

When properly aligned, the splitter **13** or riving knife **52** will be in line with the blade at both table top level, and at the top of the blade. Using a straight edge, ensure that the blade **2** is aligned with the splitter **13** or riving knife **52**. With power disconnected, operate the blade tilt and height adjustments through the extremes of travel and insure the blade guard assembly clears the blade in all operations. Refer to **Aligning Guard Assembly/ Splitter to Blade**.

 **WARNING:** Correct mounting and alignment of the blade guard assembly is essential to safe operation!

## To Remove the Blade Guard Assembly/ Riving Knife (Fig. D)

1. Pull the guard release lever **12**.
2. Lift up on blade guard assembly **11** or riving knife **52**.

## Mounting the Throat Plate (Fig. E)

1. Align the throat plate **16** as shown in Figure E, and insert the tabs on the back of the throat plate into the holes on the back of the table opening.
2. Turn the locking screw **40** clockwise 90° to lock the table insert in place.
3. The throat plate includes four adjustment screws **25** which raise or lower the throat plate. When properly adjusted, the front of the throat plate should be flush or slightly below the surface of the table top and secured in place. The rear of the throat plate should be flush or slightly above the table top.



 **WARNING:** Never use the machine without the throat plate. Immediately replace the throat plate when worn or damaged.

### To Remove the Throat Plate

1. Remove the throat plate **16** by turning the locking screw **40** 90° anti-clockwise
2. Using finger hole **26**, pull throat plate up and forward to expose the inside of the saw. DO NOT operate the saw without the throat plate. If using a dado blade, use proper dado throat plate (sold separately).

### Fitting the Rip Fence (Fig. F)

The rip fence can be installed in two positions on the right (Position 1 for 0 mm to 62 cm ripping, and Position 2 for 20.3 cm to 82.5 cm ripping) and one position on the left of your table saw.

1. Unlock the rip fence latches **18**.
2. Holding the fence at an angle, align the locator pins (front and back) **29** on the fence rails with the fence head slots **30**.
3. Slide the head slots onto the pins and rotate the fence down until it rests on the rails.
4. Lock the fence in place by closing the front and back latches **18** onto the rails.

### Bench Mounting (Fig. A)

 **CAUTION:** To reduce the risk of personal injury, make sure table saw is firmly mounted to a stable surface before use.

 **CAUTION:** Ensure that the surface is stable enough that large pieces of material will not cause it to tip over during use.

The table saw must be mounted firmly. Four holes **9** are provided in the tool's base for mounting. We strongly recommend that these holes be used to anchor the table saw to your workbench or other stationary rigid frame.

1. Centre the saw on a square piece of 12.7 mm plywood.
2. Mark the positions of the two rear mounting holes (spaced 220 mm apart) in the frame of the saw with a pencil. Then measure forward 498.5 mm for the two front holes spaced 230 mm apart.
3. Remove the saw and drill 9 mm holes in the places you have just marked.
4. Position the saw over the four holes you drilled in the plywood and insert four 8 mm machine screws FROM THE BOTTOM. Install washers and 8 mm nuts on the top. Tighten securely.
5. In order to prevent the screw heads from marring the surface to which you clamp the saw, attach two strips of scrap wood to the bottom of the plywood base. These strips can be attached with wood screws installed from the top side as long as they don't protrude through the bottom of the strip.
6. Use a "C" clamp to secure the plywood base to your workbench whenever you use the saw.

## ADJUSTMENTS

### Blade Adjustment (Fig. G)

#### Blade Alignment (Parallel to Mitre Slot)

 **WARNING:** Cut Hazard. Check the blade at 0° and 45° to make sure blade does not hit the throat plate, causing personal injury.

If the blade appears to be out of alignment with the mitre slot on the table top, it will require calibration for alignment. To realign the blade and mitre slot, use the following procedure:

 **WARNING:** To reduce the risk of injury, turn unit off and disconnect machine from power source before installing and removing accessories, before adjusting or changing set-ups or when making repairs. An accidental start-up can cause injury.

1. Using a 5 mm hex wrench, loosen rear pivot bracket fasteners **32**, located on the underside of the table, just enough to allow the bracket to move side-to-side.
2. Adjust the bracket until the blade is parallel to the mitre gauge slot.
3. Tighten the rear pivot bracket fasteners to 12.5–13.6 Nm (110–120 in-lbs).

#### Blade height adjustment (Fig. A)

The blade can be raised and lowered by turning the blade height adjustment wheel **6**.

Make sure the top three teeth of the blade are just breaking through the upper surface of the workpiece when sawing. This will ensure that the maximum number of teeth are removing material at any given time, thus giving optimum performance.

### Aligning Guard Assembly/Splitter to Blade (Fig. A, H)

1. Remove the throat plate. Refer to **Remove Throat Plate**.
2. Raise the blade to full depth of cut and 0° bevel angle.
3. Locate the three small set screws **39** adjacent to the guard assembly lock shaft **38**. These screws will be used to adjust the guard assembly position.
4. Lay a straight edge on the table against two blade tips. The splitter **13** should not touch the straight edge. If needed, loosen the two larger lock screws **41**.
5. Adjust the small set screws **39** to move the splitter according to the position noted in step 4. Lay the straight edge on the opposite side of the blade and repeat adjustments as needed.
6. Lightly tighten the two larger lock screws **41**.
7. Place a square flat against the splitter to verify splitter is vertical and in-line with the blade.
8. If needed, use the set screws to bring the splitter vertical with the square.
9. Repeat steps 4 and 5 to verify position of splitter.
10. Fully tighten the two larger lock screws **41**.
11. Re-install and lock the throat plate **16**.

## Parallel Adjustment (Fig. A, I, J, O)



**WARNING:** A misaligned fence, not parallel to the blade, increases the risk of kickback!

For optimum performance, the blade must be parallel to the rip fence. This adjustment has been made at the factory. To re-adjust:

### Position 1 Fence Alignment

1. Install the fence in position 1 and unlock the rail lock lever **5**. Locate both locator pins **29** that support the fence on the front and rear rails.
2. Loosen the rear locator pin screw and adjust the alignment of the fence in the groove until the fence face is parallel to the blade. Make sure you measure from the fence face to the front and back of the blade to ensure alignment.
3. Tighten the locator screw and repeat on the left side of the blade.
4. Check rip scale pointer adjustment (Fig. J).

### Position 2 Fence Alignment

1. To align position 2 fence locator pins **29**, ensure position 1 pins have been aligned, refer to **Position 1 Fence Alignment**.
2. Loosen the position 2 pins, then using the blade wrench holes as a guide for positioning, align the pins (Fig. O).
3. Tighten the locator pins (front and rear).

## Adjusting the Rip Scale (Fig. A, J)

1. Unlock the rail lock lever **5**.
2. Set the blade at 0° bevel and move the fence in until it touches the blade.
3. Lock the rail lock lever.
4. Loosen the rip scale indicator screws **31** and set the rip scale indicator to read zero (0). Retighten the rip scale indicator screws. The yellow rip scale (top) reads correctly only when the fence is mounted on the right side of the blade and is in position 1 (for zero to 62 cm ripping) not the 82.5 cm rip position. The white scale (bottom) reads correctly only when the fence is mounted on the right side of the blade and in position 2 (for 20.3 cm to 82.5 cm ripping).

The rip scale reads correctly only when the fence is mounted to the right of the blade.

## Rail Lock Adjustment (Fig. A, K)

The rail lock has been factory-set. If you need to re-adjust, proceed as follows:

1. Lock the rail lock lever **5**.
2. On the underside of the saw, loosen the jam nut **33**.
3. Tighten the hex rod **34** until the spring on the locking system is compressed creating the desired tension on the rail lock lever. Retighten the jam nut against the hex rod.
4. Flip the saw over and check that the fence does not move when the lock lever is engaged. If the fence is still loose, tighten the spring further.

## Bevel Stop and Pointer Adjustment (Fig. L)

1. Raise the blade fully by rotating the blade height adjustment wheel **6** clockwise until it stops.
2. Unlock the bevel lock lever **7** by pushing it up and to the right. Loosen the bevel stop screw **36**.
3. Place a square flat against the table top and against the blade between teeth. Ensure the bevel lock lever is in its unlocked, or up position.
4. Using the bevel lock lever, adjust the bevel angle until the blade is flat against the square.
5. Tighten the bevel lock lever by pushing it down.
6. Turn the bevel stop cam **35** until it firmly contacts the bearing block. Tighten the bevel stop screw **36**.
7. Check the bevel angle scale. If the pointer does not read 0°, loosen pointer screw **37** and move the pointer so it reads correctly. Retighten the pointer screw.
8. Repeat at 45°, but do not adjust pointer.

## Mitre Gauge Adjustment (Fig. A)

To adjust mitre gauge **10** loosen knob, set to desired angle and tighten knob.

## Body and Hand Position

Proper positioning of your body and hands when operating the table saw will make cutting easier, more accurate and safer.



### WARNING:

- Never place your hands near the cutting area.
- Place your hands no closer than 150 mm from the blade.
- Do not cross your hands.
- Keep both feet firmly on the floor and maintain proper balance.

## Prior to Operation



### WARNING:

- Install the appropriate saw blade. Do not use excessively worn blades. The maximum rotation speed of the tool must not exceed that of the saw blade.
- Do not attempt to cut excessively small pieces.
- Allow the blade to cut freely. Do not force.
- Allow the motor to reach full speed before cutting.

## OPERATION

### Instructions for Use



**WARNING:** Always observe the safety instructions and applicable regulations.



**WARNING:** To reduce the risk of serious personal injury, turn tool off and disconnect tool from power source before making any adjustments or removing/installing attachments or accessories. An accidental start-up can cause injury.

The attention of UK users is drawn to the "woodworking machines regulations 1974" and any subsequent amendments.

Ensure the machine is placed to satisfy your ergonomic conditions in terms of table height and stability. The machine site shall be chosen so that the operator has a good overview and enough free surrounding space around the machine that allows handling of the workpiece without any restrictions. To reduce effects of increased vibration, make sure the environment is not too cold, the machine and accessory are well maintained and the workpiece size is suitable for this machine.



#### **WARNING:**

- *Ensure the machine is placed to satisfy ergonomic conditions in terms of table height and stability. The machine site shall be chosen so that the operator has a good overview and enough free surrounding space around the machine that allow handling of the workpiece without any restrictions.*
- *Install the appropriate saw blade. Do not use excessively worn blades. The maximum rotation speed of the tool must not exceed that of the saw blade.*
- *Do not attempt to cut excessively small pieces.*
- *Allow the blade to cut freely. Do not force.*
- *Allow the motor to reach full speed before cutting.*
- *Make sure all locking knobs and clamp handles are tight.*
- *Never place either hand in the blade area when the saw is connected to the electrical power source.*
- *Never use your saw for freehand cuts!*
- *Do not saw warped, bowed or cupped workpieces. There must be at least one straight, smooth side to go against the rip fence or mitre fence.*
- *Always support long workpieces to prevent kickback.*
- *Do not remove any cut-offs from the blade area while the blade is running.*

## **Switching On and Off (Fig. M)**

The on/off switch **8** of your saw bench offers multiple advantages:

- No-volt release function: should the power be shut off for any reason, the switch has to be deliberately reactivated.
- To switch the machine on, press the green start button.
- To switch the machine off, press the red stop button.

## **Lock Off Feature Instructions**

A cover above the switch folds down for insertion of a padlock to lock the saw off. A padlock with a maximum diameter of 6.35 mm and minimum clearance of 76.2 mm is recommended.

## **Rip Fence Operation (Fig. N–P)**

### **Rail lock lever**

The rail lock lever **5** locks the fence in place preventing movement during cutting. To lock the rail lever, push it down and toward the rear of the saw. To unlock, pull it up and toward the front of the saw.

**NOTE:** When ripping, always lock the rail lock lever.

## **Work Support Extension / Narrow Ripping Fence**

Your table saw is equipped with a work support extension to support work that extends beyond the saw table.

To use the narrow ripping fence in the work support position, rotate it from its stored position as shown in Figure O, and slide the pins into the lower sets of slots **27** on both ends of the fence.

To use the narrow ripping fence in the narrow ripping position, snap the pins into the upper sets of slots **28** on both ends of the fence. This feature will allow 51 mm of extra clearance to the blade. Refer to Figure P.

**NOTE:** Retract the work support extension or adjust to narrow rip fence position whenever working over the table.

**NOTE:** When using the narrow ripping fence, subtract 51 mm from the indicated rip scale reading.

### **Fine Adjustment Knob**

The fine adjustment knob **4** allows smaller adjustments when setting the fence. Before adjusting, be sure the rail lock lever is in its up or unlocked, position.

### **Rip Scale Pointer**

The rip scale pointer will need to be adjusted for proper performance of the rip fence if the user switches between thick and thin kerf blades. The rip scale pointer only reads correctly when the fence is installed in position 1 or 2 to the right side of the blade. When using the narrow ripping fence for narrow ripping (not in work support position), subtract 51 mm from the indicated rip scale reading. See **Adjusting the Rip Scale** under **Adjustments**.

## **BASIC SAW CUTS**

### **Through-Cutting Operations**



**WARNING:** Use blade guard assembly for all through-cutting operations.

### **Ripping (Fig. A, B, Q, R)**



**WARNING:** Sharp edges.

1. Set the blade to 0°.
2. Install the rip fence and lock the rip fence latch **18** (Fig. A).
3. Raise the blade until it is about 3 mm higher than the top of the workpiece. Adjust the height of the upper blade guard as necessary.
4. Adjust the position of the fence and lock the rail lock lever **5**, refer to **Rip Fence Operation**.
5. Hold the workpiece flat on the table and against the fence. Keep the workpiece away from the blade.
6. Keep both hands away from the path of the blade (Fig. Q).
7. Switch the machine on and allow the blade to reach full speed.
8. Slowly feed the workpiece underneath the guard, keeping it firmly pressed against the rip fence. Allow the teeth to cut, and do not force the workpiece through the blade. The blade speed should be kept constant.

9. Always use a push stick **21** when working close to the blade (Fig. R).
10. After completing the cut, switch the machine off, allow the blade to stop and remove the workpiece.

### **WARNING:**

- Never push or hold the "free" or cut-off-side of the workpiece.
- Do not cut excessively small workpieces.
- Always use a push stick when ripping small workpieces.

## Bevel Cuts (Fig. A)

1. To set the required bevel angle, rotate the bevel lock lever **7** by pushing it up and to the right.
2. To set to desired angle, rotate the lever by pushing it down and to the left to lock in place.
3. Proceed as for ripping.

## Cross-Cutting and Bevel Crosscutting (Fig. Q)

1. Remove the rip fence and install the mitre gauge in the desired slot.
2. Lock the mitre gauge at 0°.
3. Proceed as for ripping.

## Mitre Cuts (Fig. A)

1. Set the mitre gauge **10** to the required angle.

**NOTE:** Always hold the workpiece tightly against the face of the mitre gauge.

2. Proceed as for ripping.

## Compound Mitre

This cut is a combination of a mitre and a bevel cut. Set the bevel to the angle required and proceed as for a cross-cut mitre.

## Support for Long Pieces

- Always support long pieces.
- Support long workpieces using any convenient means such as saw-horses or similar devices to keep the ends from dropping.

## Non-Through-Cutting (Grooving and Rabbeting)

-  **WARNING:** Remove the blade guard assembly **11** and install the non-through-cutting riving knife **52** for non-through-cutting operations. Use featherboards for all non-through-cutting operations where the blade guard assembly, anti-kickback assembly and riving knife cannot be used.

Instructions in the **Ripping, Crosscutting, Bevel Crosscutting, Mitreing**, and **Compound Mitreing** sections are for cuts made through the full thickness of the material. The saw can also perform non-through cuts to form grooves or rabbets in the material.

## Non-Through-Ripping (Fig. D, U)

-  **WARNING:** A rip fence should **ALWAYS** be used for ripping operations to prevent loss of control and personal injury. **NEVER** perform a ripping operation freehand. **ALWAYS** lock the fence to the rail.

-  **WARNING:** When bevel ripping and whenever possible, place the fence on the side of the blade so that the blade is tilted away from the fence and hands.

-  **WARNING:** Keep hands clear of the blade. With non-through-cutting the blade is not always visible during the cut, so increased caution is necessary to ensure hands are clear of the blade.

-  **WARNING:** Use a push stick to feed the workpiece if there are 51–152 mm between the fence and the blade. Use a narrow ripping fence feature and push block to feed the workpiece if there are 51 mm or narrower between the fence and the blade.

1. Remove the blade guard assembly **11** and install the non-through-cutting riving knife **52** (Fig. D). Refer to: **Mounting the Blade Guard Assembly/Riving Knife**.
2. Lock the rip fence by pressing the rail lock lever down. Remove the mitre gauge.
3. Raise the blade to the desired cut depth.
4. Hold the workpiece flat on the table and against the fence. Keep the workpiece about 25.4 mm away from the blade.

-  **WARNING:** The workpiece must have a straight edge against the fence and must not be warped, twisted or bowed. Keep both hands away from the blade and away from the path of the blade. See proper hand position in Figure U.

5. Turn the saw on and allow the blade to come up to speed. Both hands can be used in starting the cut. When there are approximately 305 mm left to be ripped, use only one hand, with your thumb pushing the material, your index and second finger holding the material down and your other fingers hooked over the fence. Always keep your thumb along side your first two fingers and near the fence.
6. Keeping the workpiece against the table and fence, slowly feed the workpiece rearward all the way through the saw blade. Continue pushing the workpiece until it is clear of the blade guard assembly and it falls off the rear of the table. Do not overload the motor.
7. Never try to pull the workpiece back with the blade turning. Turn the switch off, allow the blade to stop and slide the workpiece out.
8. When sawing a long piece of material or a panel, always use a work support. A sawhorse, rollers, or out feed assembly provides adequate support for this purpose. The work support must be at the same height or slightly lower than the saw table.

## Non-Through-Ripping Small Pieces (Fig. A)

It is unsafe to rip small pieces. It is not safe to put your hands close to the blade. Instead, rip a larger piece to obtain the desired piece. When a small width is to be ripped and the hand cannot be safely put between the blade and the rip fence, use one or more push sticks. A push stick **21** is included with this

saw, attached to the rip fence. Use the push stick(s) to hold the workpiece against the table and fence, and push the workpiece fully past the blade.

### Non-Through-Bevel Ripping (Fig. V)

This operation is the same as non-through-cut ripping except the bevel angle is set to an angle other than zero degrees. For proper hand position, Refer to Figure V.



**WARNING:** Before connecting to power source or operating the saw, always inspect the riving knife for proper alignment and clearance with saw blade. Check alignment after each change of bevel angle.

### Non-Through-Crosscutting (Fig. W)



**WARNING:** NEVER use rip fence in combination with mitre gauge.



**WARNING:** To reduce the risk of injury, NEVER use the fence as a guide or length stop when crosscutting.



**WARNING:** When using a block as a cut-off gauge, the block must be at least 19 mm thick and is very important that the rear end of the block be positioned so the workpiece is clear of the block before it enters the blade to prevent contact with blade resulting in a thrown workpiece and possibly injury.

1. Remove the rip fence and place the mitre gauge in the desired slot.
2. Adjust the blade height to the desired cut depth.
3. Hold the workpiece firmly against the mitre gauge **10** with the path of the blade in line with the desired cut location. Keep the workpiece an inch or so in front of the blade. KEEP BOTH HANDS AWAY FROM THE BLADE AND THE PATH OF THE BLADE (Fig. W).
4. Start the saw motor and allow the blade to come up to speed.
5. While using both hands to keep the workpiece against the face of the mitre gauge, and holding the workpiece flat against the table, slowly push the workpiece through the blade.
6. Never try to pull the workpiece with the blade turning. Turn the switch off, allow the blade to stop, and carefully slide the workpiece out.

### Non-Through-Bevel Crosscutting

This operation is the same as crosscutting except that the bevel angle is set to an angle other than 0°.



**WARNING:** Before connecting to power source or operating the saw, always inspect the riving knife for proper alignment and clearance with saw blade. Check alignment after each change of bevel angle.

### Non-Through-Mitreing (Fig. W)

This operation is the same as crosscutting except the mitre gauge is locked at an angle other than 0°. Hold the workpiece FIRMLY against the mitre gauge **10** and feed the workpiece slowly into the blade (to prevent the workpiece from moving).

### Non-Through-Mitre Gauge Operation

To set your mitre gauge:

1. Loosen the mitre gauge lock knob **46**.
2. Move the mitre gauge to the desired angle.
3. Tighten the mitre gauge lock knob.

### Non-Through-Compound Mitreing

This is a combination of non-through-bevel crosscutting and non-through-mitreing. Follow the instructions for both non-through-bevel crosscutting and non-through-mitreing.



### Dust extraction (Fig. A, AA)

The machine is provided with a dust exhaust port **14** at the rear of the machine suitable for use with dust extraction equipment featuring 57/65 mm nozzles. Supplied with the machine is a reducer port for use of dust extraction nozzles<sup>Ⓝ</sup> of 34–40 mm diameter.

Supplied with the machine is a reducer port for use with the DEWALT AirLock system (DWV9000-XJ).

The blade guard assembly also features a dust exhaust port for 35mm nozzles or direct attachment to the DEWALT AirLock (DWV9000-XJ).

Dust from materials such as lead-containing coatings and some wood types, can be harmful to one's health. Breathing-in the dust can cause allergic reactions and/or lead to respiratory infections of the user or bystanders.

Certain dust, such as oak or beech dust, is considered carcinogenic, especially in connection with wood-treatment additives.

Observe the relevant regulations in your country for the materials to be worked.

The vacuum cleaner must be suitable for the material being worked.

When vacuuming dry dust that is especially detrimental to health or carcinogenic, use dust class M vacuum cleaner.

The blade guard assembly also features a dust exhaust port for 35 mm nozzles (M class vacuum).

- During all operations, connect a dust extraction device designed in accordance with the relevant regulations regarding dust emission.
- Ensure that the dust extraction hose in use is suitable for the application and material being cut. Ensure proper hose management.
- Be aware that man-made materials such as chipboard or MDF produce more dust particles during cutting than natural timber.

### Storage (Fig. B, X–Z)

Store the machine in a safe manner when not being used. The storage location must be dry and lockable. This prevents the machine from storage damage, and from being operated by untrained persons.

1. Attach push stick **21** to fence.

- Remove blade guard assembly. See **To Remove Blade Guard Assembly**. Slide blade guard assembly **11** into holder as shown, then turn lock knob 1/4 to lock in place. Refer to Figure X.
- Slide blade wrenches **20** into pocket until yellow button aligns with hole to secure in place, refer to Figure B.
- Insert guide bar of mitre gauge into pocket until it bottoms out.
- Wrap cord in this location **43**. Refer to Figure Z.
- To store fence, snap work support in stored position. Remove fence from rails. Reattach fence upside down on left side of saw, refer to Figure Y. DO NOT hook locator slots on left side fence locator screws. These screws will align with clearance pocket on fence as shown. Close the rip fence latches **18** to secure.
- Non-through cutting riving knife **52** can be installed in the saw (working position) or stored along with the blade guard assembly. Refer to Figure B.

## Transporting (Fig. A, B)

Before transportation following has to be done:

- Wrap cord
- Turn the blade height adjustment wheel **6** in anticlockwise direction until the teeth of the saw blade are positioned below the saw table. Lock the bevel lock lever **7**.
- Slide the fence rails completely inward and fix it by rail lock lever **5**.
- Always carry the machine using the designated handles **50**, refer to Figures A and B.

 **WARNING:** Always transport the machine with the upper blade guard fitted.

## MAINTENANCE

Your DEWALT power tool has been designed to operate over a long period of time with a minimum of maintenance. Continuous satisfactory operation depends upon proper tool care and regular cleaning.

 **WARNING:** To reduce the risk of serious personal injury, turn tool off and disconnect tool from power source before making any adjustments or removing/installing attachments or accessories. An accidental start-up can cause injury.







## Lubrication (Fig. T)

The motor and bearings require no additional lubrication. If raising and lowering the blade becomes difficult, clean and grease the height adjustment screws:

- Unplug the saw from power source.
- Turn the saw on its side.
- Clean and lubricate the height adjustment screw threads **42** on the underside of this saw as shown in Figure T. Use general purpose grease.



## Cleaning (Fig. A, S)

-  **WARNING:** To reduce the risk of serious personal injury, turn unit off and disconnect machine from power source before cleaning. An accidental start-up can cause injury.
-  **WARNING:** Blow dirt and dust out of the main housing with dry air as often as dirt is seen collecting in and around the air vents. Wear approved eye protection and approved dust mask when performing this procedure.
-  **WARNING:** Never use solvents or other harsh chemicals for cleaning the non-metallic parts of the tool. These chemicals may weaken the materials used in these parts. Use a cloth dampened only with water and mild soap. Never let any liquid get inside the tool; never immerse any part of the tool into a liquid.
-  **WARNING:** To reduce the risk of injury, regularly clean the table top.
-  **WARNING:** To reduce the risk of injury, regularly clean the dust collection system.

The blade guard assembly **11** and throat plate must be placed in position before operating the saw.

Before use, carefully inspect upper and lower blade guards as well as the dust extraction tube to determine that it will operate properly. Ensure that chips, dust or work piece particles cannot lead to blockage of one of the functions.

In case workpiece fragments are jammed between saw blade and guards, disconnect the machine from the power supply and follow the instructions given in section **Mounting the saw blade**. Remove the jammed parts and reassemble the saw blade.

Keep the ventilation slots clear and regularly clean the housing with a soft cloth.

Regularly clean the dust collection system:

- Unplug the saw.
- Turn the saw on its side, so the bottom, open part of the unit is accessible.
- Open the dust access door **44** shown in Figure S loosening the two screws and then by pressing the side clips **45** toward each other. Clean out the excess dust, and re-secure by pushing the side clips completely into place then tightening the lock screws.

## Optional Accessories

 **WARNING:** Since accessories, other than those offered by DEWALT, have not been tested with this product, use of such accessories with this tool could be hazardous. To reduce the risk of injury, only DEWALT recommended accessories should be used with this product.

Consult your dealer for further information on the appropriate accessories.

Replace blade guard when worn. Contact your local DEWALT service centre for details on a blade guard replacement.

**SAW BLADES:** ALWAYS USE 250 mm noise reduced saw blades with 30 mm arbour holes. Blade speed rating must be at least 5000 RPM. Never use a smaller diameter blade. It will not be guarded properly.

#### BLADE DESCRIPTIONS

APPLICATION	DIAMETER	TEETH
<b>Construction Saw Blades</b> ( <i>fast rip</i> )		
General Purpose	250 mm	24
Fine Crosscuts	250 mm	40
<b>Woodworking Saw Blades</b> ( <i>provide smooth, clean cuts</i> )		
Fine crosscuts	250 mm	60

Consult your dealer for further information on the appropriate accessories.

- DWE74911 Rolling Table Saw Stand
- DWE74912 Scissor Leg Stand

## Protecting the Environment



Separate collection. Products and batteries marked with this symbol must not be disposed of with normal household waste.



Products and batteries contain materials that can be recovered or recycled reducing the demand for raw materials. Please recycle electrical products and batteries according to local provisions. Further information is available at [www.2helpU.com](http://www.2helpU.com).



МАГАЗИН  
БАШ МАЙСТОРА®  
ПРОФЕСИОНАЛНИ РЕШЕНИЯ



<b>Belgique et Luxembourg België en Luxemburg</b>	DeWALT - Belgium BVBA Egide Walschaertsstraat 16 2800 Mechelen	Tel: NL 32 15 47 37 63 Tel: FR 32 15 47 37 64 Fax: 32 15 47 37 99	<a href="http://www.dewalt.be">www.dewalt.be</a> <a href="mailto:enderuser.BE@sbdinc.com">enderuser.BE@sbdinc.com</a>
<b>Danmark</b>	DeWALT (Stanley Black&Decker AS) Roskildevej 22 2620 Albertslund	Tel: 70 20 15 10 Fax: 70 22 49 10	<a href="http://www.dewalt.dk">www.dewalt.dk</a> <a href="mailto:kundeservice.dk@sbdinc.com">kundeservice.dk@sbdinc.com</a>
<b>Deutschland</b>	DeWALT Richard-Klinger-Str. 11 65510 Idstein	Tel: 06126-21-0 Fax: 06126-21-2770	<a href="http://www.dewalt.de">www.dewalt.de</a> <a href="mailto:infodwge@sbdinc.com">infodwge@sbdinc.com</a>
<b>Ελλάδα</b>	DeWALT (Ελλάδα) Α.Ε. ΕΑΡΑ-ΓΡΑΦΕΙΑ : Στραβωνος 7 & Α. Βουλιαμενης, Γλυφάδα 166 74, Αθήνα SERVICE : Ημερος Τόπος 2 (Χάνι Αδάμ) – 193 00 Ασπρόπυργος	Τηλ: 00302108981616 Φαξ: 00302108983570	<a href="http://www.dewalt.gr">www.dewalt.gr</a> <a href="mailto:Greece.Service@sbdinc.com">Greece.Service@sbdinc.com</a>
<b>España</b>	DeWALT Ibérica, S.C.A. Parc de Negocios "Mas Blau" Edificio Muntadas, c/Bergadà, 1, Of. A6 08820 El Prat de Llobregat (Barcelona)	Tel: 934 797 400 Fax: 934 797 419	<a href="http://www.dewalt.es">www.dewalt.es</a> <a href="mailto:respuesta.postventa@sbdinc.com">respuesta.postventa@sbdinc.com</a>
<b>France</b>	DeWALT (Stanley Black & Decker France SAS) 62 Chemin de la Bruyère CS 60105, 69574 DARDILLY Cedex	Tel: 04 72 20 39 20 Fax: 04 72 20 39 00	<a href="http://www.dewalt.fr">www.dewalt.fr</a> <a href="mailto:sucffr@sbdinc.com">sucffr@sbdinc.com</a>
<b>Schweiz Suisse Svizzera</b>	DeWALT In der Luberzen 42 8902 Urdorf	Tel: 044 - 755 60 70 Fax: 044 - 730 70 67	<a href="http://www.dewalt.ch">www.dewalt.ch</a> <a href="mailto:service@rafoag.ch">service@rafoag.ch</a>
<b>Ireland</b>	DeWALT Building 4500, Kinsale Road Cork Airport Business Park Cork, Ireland	Tel: 00353-2781800 Fax: 01278 1811	<a href="http://www.dewalt.ie">www.dewalt.ie</a> <a href="mailto:Sales.ireland@sbdinc.com">Sales.ireland@sbdinc.com</a>
<b>Italia</b>	DeWALT via EnergyPark 6 20871 Vimercate (MB), IT	Tel: 800-014353 Fax: 39 039-9590200 39 039-9590311	<a href="http://www.dewalt.it">www.dewalt.it</a>
<b>Nederlands</b>	DeWALT Netherlands BVPostbus 83, 6120 AB BORN	Tel: 31 164 283 063 Fax: 31 164 283 200	<a href="http://www.dewalt.nl">www.dewalt.nl</a>
<b>Norge</b>	DeWALT Postboks 4613 0405 Oslo, Norge	Tel: 45 25 13 00 Fax: 45 25 08 00	<a href="http://www.dewalt.no">www.dewalt.no</a> <a href="mailto:kundeservice.no@sbdinc.com">kundeservice.no@sbdinc.com</a>
<b>Österreich</b>	DeWALT Werkzeug Vertriebsges.m.b.H. Oberlaaerstrasse 248, A-1230 Wien	Tel: 01 - 66116 - 0 Fax: 01 - 66116 - 614	<a href="http://www.dewalt.at">www.dewalt.at</a> <a href="mailto:service.austria@sbdinc.com">service.austria@sbdinc.com</a>
<b>Portugal</b>	DeWALT Ed. D Dimis, Quina da Fonte Rua dos Malhoes 2, 2A 2º Esq. Oeiras e S. Juliao da Barra, paço de Arcos e Caxias 2770 071 Paço de Arcos	Tel: +351 214667500 Fax: +351 214667580	<a href="http://www.dewalt.pt">www.dewalt.pt</a> <a href="mailto:resposta.posvenda@sbdinc.com">resposta.posvenda@sbdinc.com</a>
<b>Suomi</b>	DeWALT PL47 00521 Helsinki, Suomi	Puh: 010 400 4333 Fakst: 0800 411 340	<a href="http://www.dewalt.fi">www.dewalt.fi</a> <a href="mailto:asiakaspalvelu.fi@sbdinc.com">asiakaspalvelu.fi@sbdinc.com</a>
<b>Sverige</b>	DeWALT BOX 94 43122 Mölndal Sverige	Tel: 031 68 61 60 Fax: 031 68 60 08	<a href="http://www.dewalt.se">www.dewalt.se</a> <a href="mailto:kundservice.se@sbdinc.com">kundservice.se@sbdinc.com</a>
<b>Türkiye</b>	Sanayi ve Ticaret Bakanligi tebligine kullanim ömrü 7 yıldır. Stanley Black & Decker Turkey Alet Üretim San. Tic. Ltd.Şti. AND Kozyatađı - İçerenköy Mah. Umut Sok. AND Ofis Sit. No: 10-12 / 82-83-84 Ataşehir/İstanbul, Türkiye	Tel: +90 216 665 2900 Faks: +90 216 665 2901	<a href="http://www.dewalt.com.tr">www.dewalt.com.tr</a> <a href="mailto:support@dewalt.com.tr">support@dewalt.com.tr</a>
<b>United Kingdom</b>	DeWALT, 270 Bath Road; Slough, Berks SL1 4DX	Tel: 01753-567055 Fax: 01753-572112	<a href="http://www.dewalt.co.uk">www.dewalt.co.uk</a> <a href="mailto:emeaservice@sbdinc.com">emeaservice@sbdinc.com</a>
<b>Australia / New Zealand</b>	DeWALT 810 Whitehorse Road Box Hill VIC 3128 Australia	Tel: Aust 1800 338 002 Tel: NZ 0800 339 258	<a href="http://www.dewalt.com.au">www.dewalt.com.au</a> <a href="http://www.dewalt.co.nz">www.dewalt.co.nz</a>
<b>Middle East Africa</b>	DeWALT P.O. Box - 17164, Jebel Ali Free Zone (South), Dubai, UAE	Tel: 971 4 812 7400 Fax: 971 4 2822765	<a href="http://www.dewalt.ae">www.dewalt.ae</a> <a href="mailto:support@dewalt.ae">support@dewalt.ae</a>