

## Table of Contents

<b>Instrument Set-up</b> .....	<b>2</b>	<b>Transport</b> .....	<b>18</b>
Introduction.....	2	<b>Storage</b> .....	<b>18</b>
Overview - Laser.....	3	<b>Cleaning and Drying</b> .....	<b>18</b>
Overview - Receiver .....	4	<b>Safety Instructions</b> .....	<b>19</b>
Overview - Remote Control .....	5	Areas of responsibility .....	19
Accessories .....	6	Permitted use .....	19
<b>Operations</b> .....	<b>7</b>	Limits of use .....	19
Typical uses .....	7	Prohibited use .....	19
Switching ON / Automatic mode .....	8	Noise emissions (laser receiver) .....	20
Switching OFF .....	8	Hazards in use .....	20
Manual mode .....	8	Disposal .....	20
H.I. Alert mode .....	9	Electromagnetic Compatibility (EMC).....	21
<b>Applications</b> .....	<b>10</b>	FCC statement (applicable in U.S.) .....	21
Rotating .....	10	Laser classification.....	22
Scanning .....	10	Labelling.....	22
<b>Button Functions - Upright Mode</b> .....	<b>11</b>		
<b>Button Functions - Laydown Mode</b> .....	<b>12</b>		
<b>Alignment applications</b> .....	<b>13</b>		
Ceiling work .....	13		
Layout or floor work.....	13		
Level fixing points .....	14		
Water pipe assembly.....	14		
Floor leveling .....	15		
Formwork leveling.....	15		
<b>Checking the accuracy</b> .....	<b>16</b>		
Level accuracy .....	16		
Vertical accuracy.....	16		
<b>Technical Data</b> .....	<b>17</b>		

# Instrument Set-up

## Introduction



The safety instructions and the user manual should be read through carefully before the product is used for the first time.



The person responsible for the product must ensure that all users understand these directions and adhere to them.

The symbols used have the following meanings:

### **WARNING**

Indicates a potentially hazardous situation or an unintended use which, if not avoided, will result in death or serious injury.

### **CAUTION**

Indicates a potentially hazardous situation or an unintended use which, if not avoided, may result in minor injury and/or appreciable material, financial and environmental damage.

-  Important paragraphs which must be adhered to in practice as they enable the product to be used in a technically correct and efficient manner.



БАШ МАЙСТОРА®  
ПРОФЕСИОНАЛНИ РЕШЕНИЯ

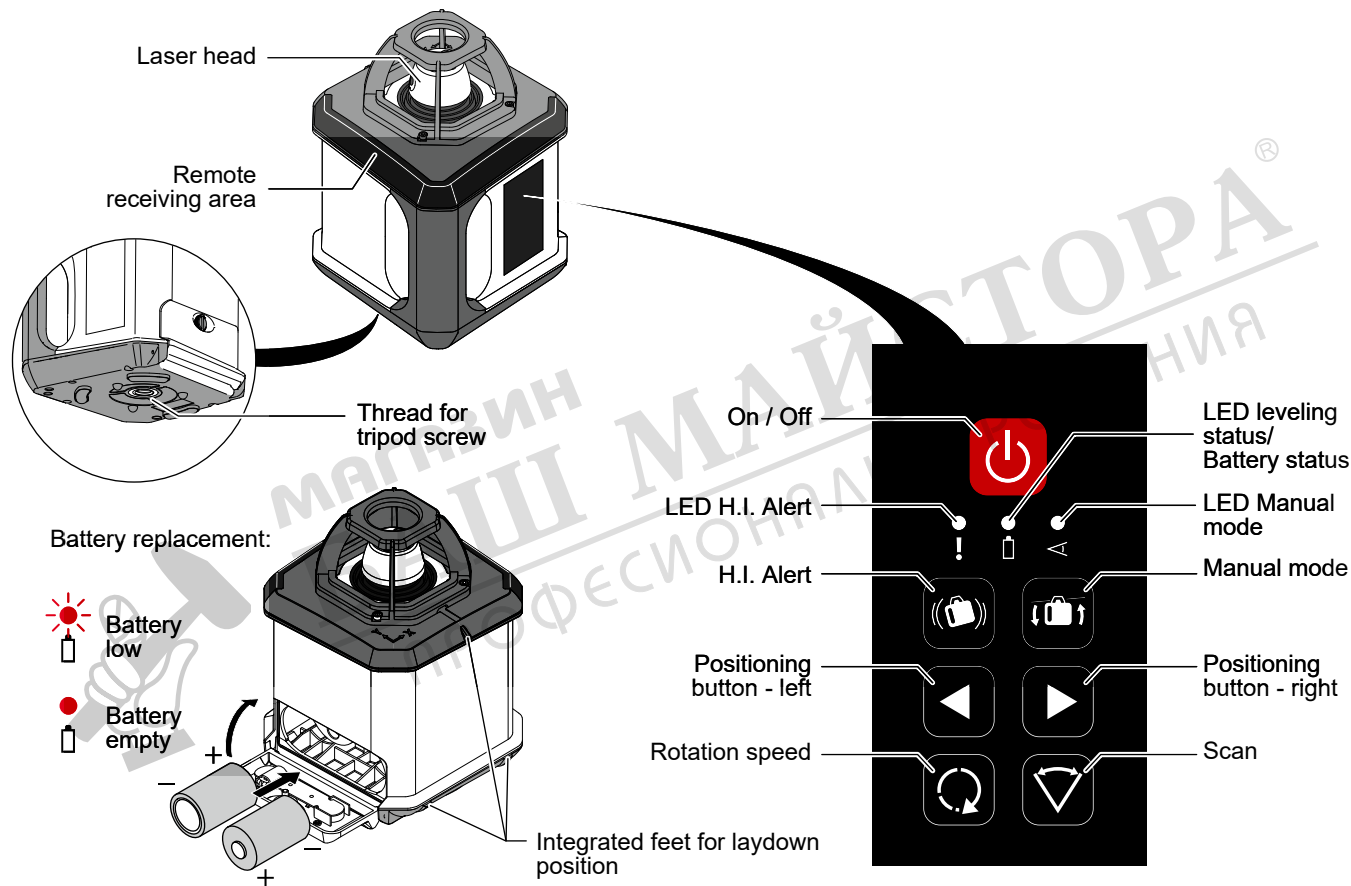

# Instrument Set-up

## Overview - Receiver

Clamp for mounting the receiver:

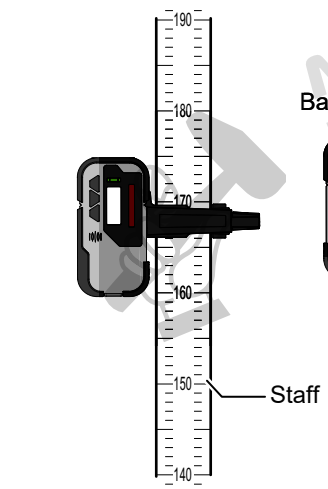
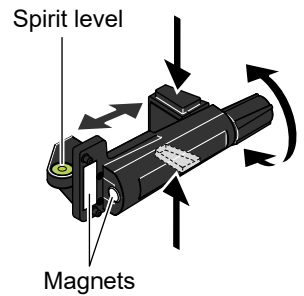

Backside:

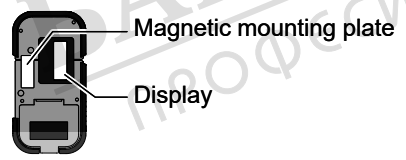

Battery replacement:

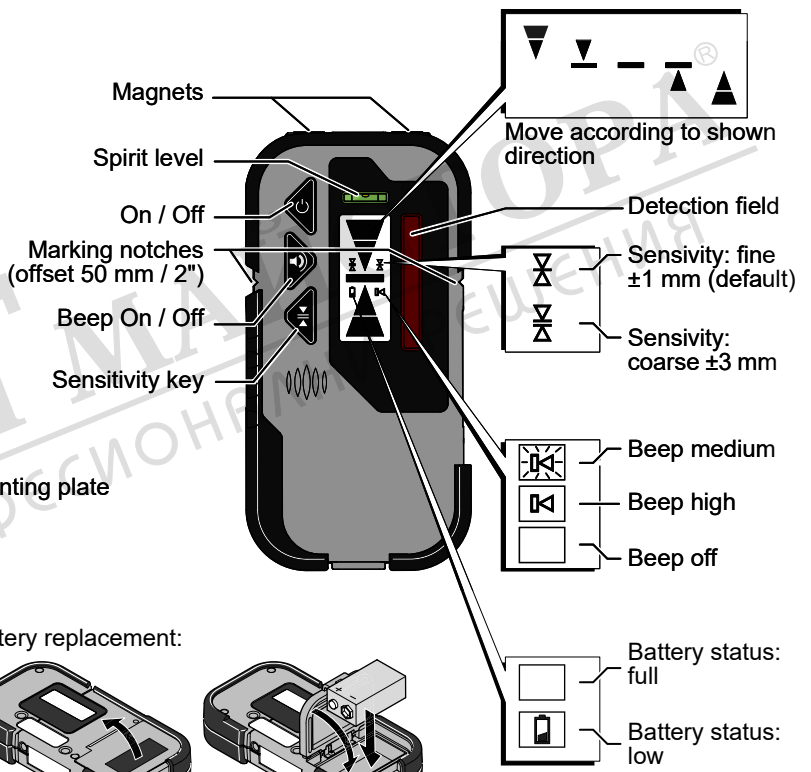
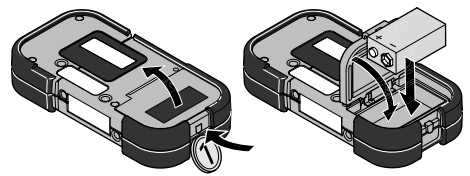

## Overview - Remote Control

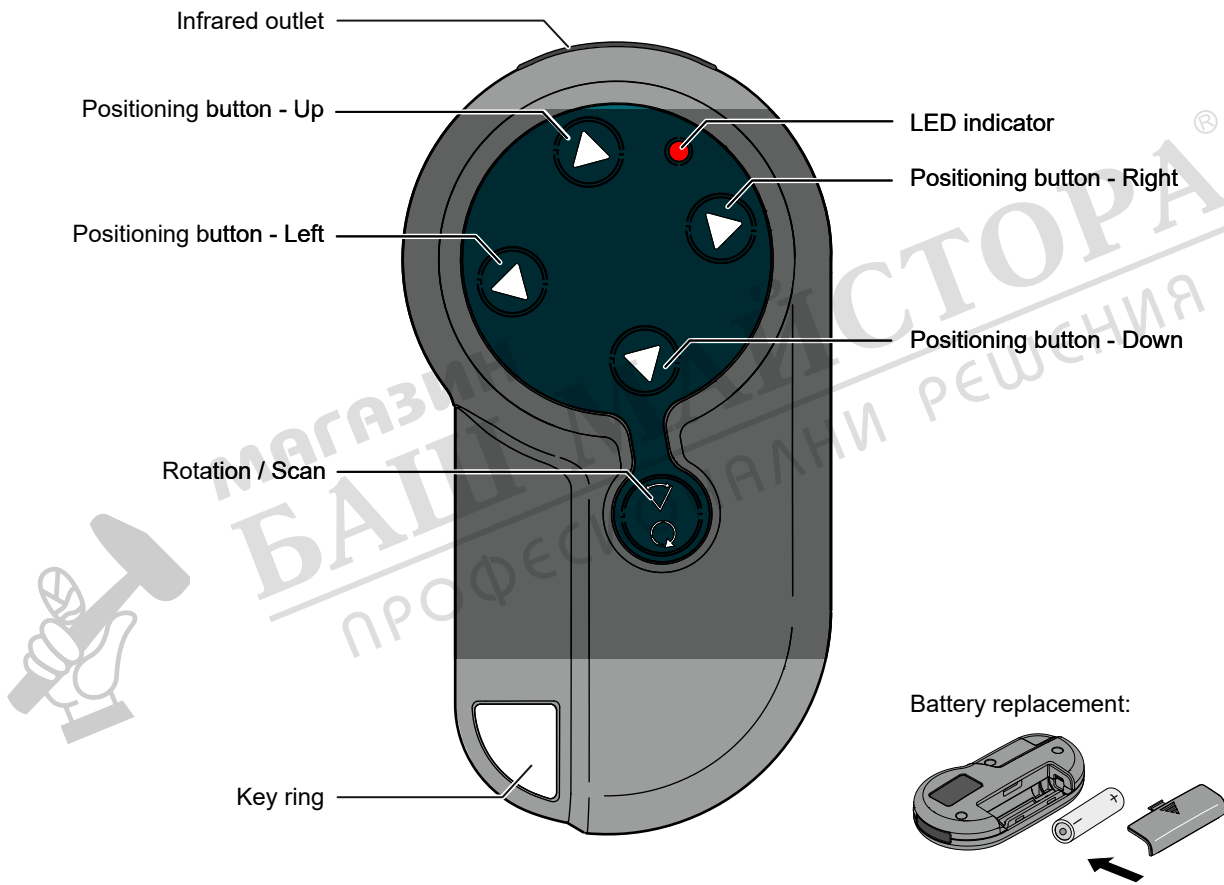

# Instrument Set-up

## Accessories

Wallmount:

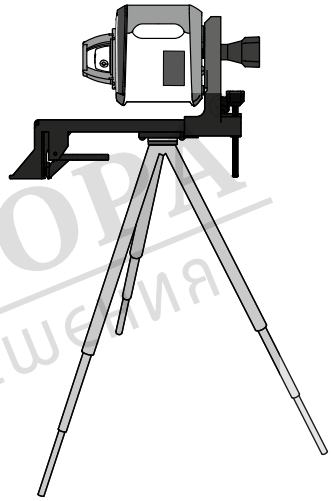
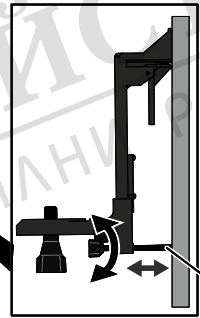
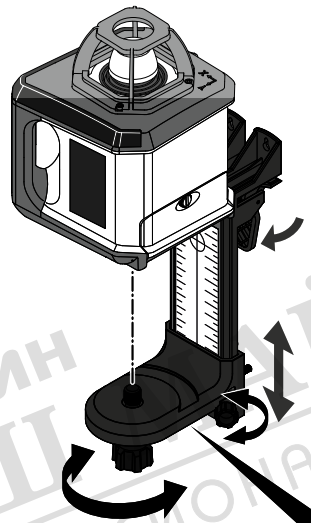
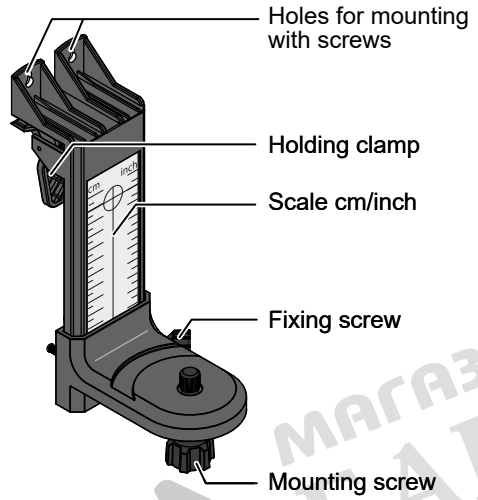

Adjustment screw



Target plate:

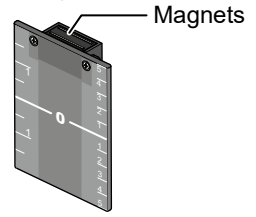

Goggles:

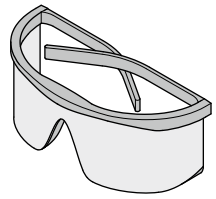

**WARNING!**  
 The goggles do not protect your eyes against the laser beam. It is only used to increase the visibility of the laser beam.

# Operations

## Typical uses

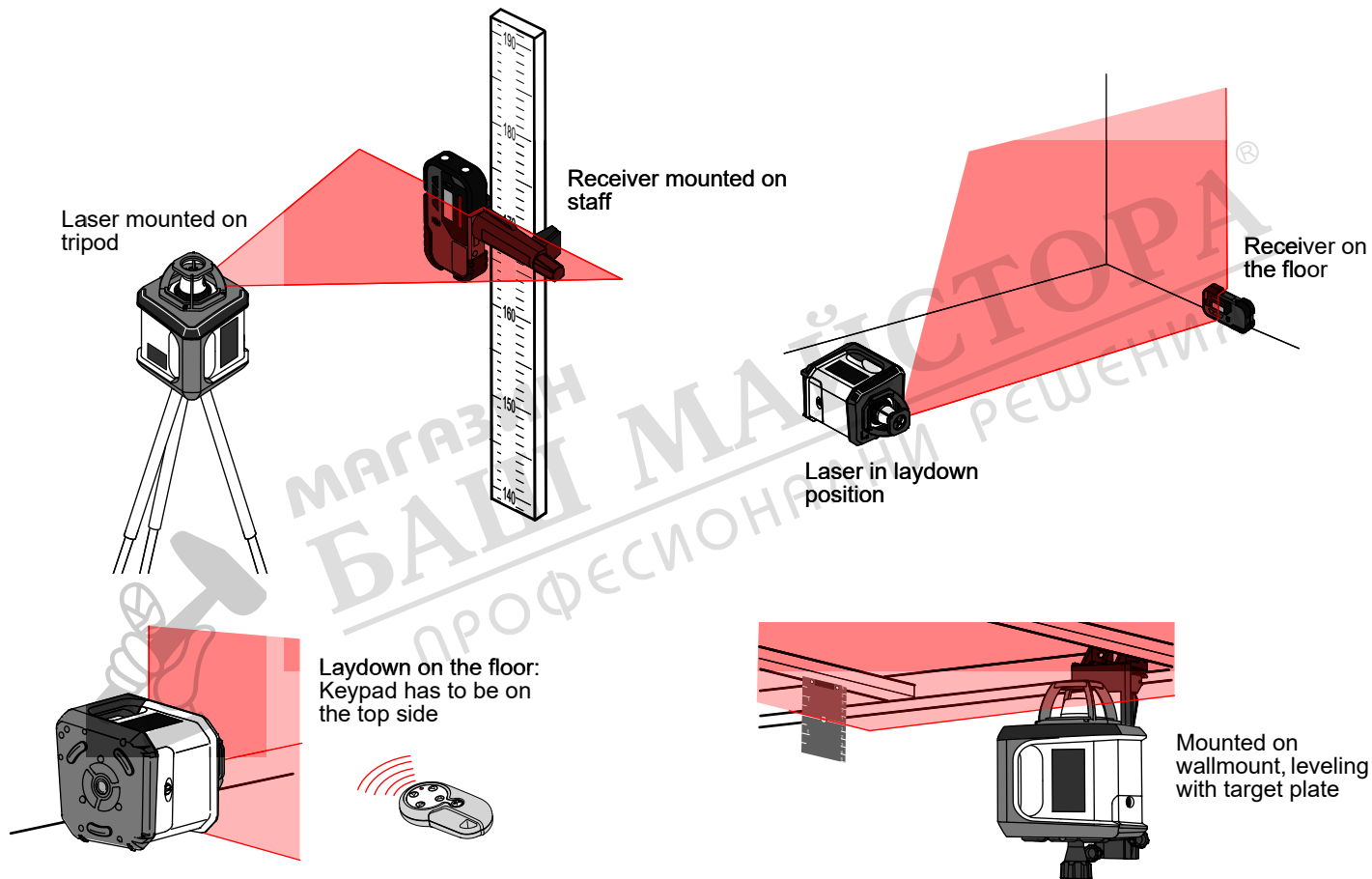

# Operations

## Switching ON / Automatic mode

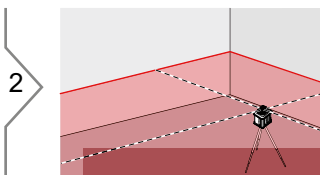
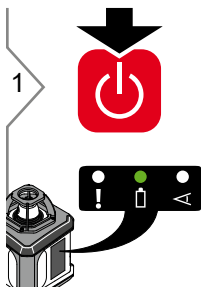

After turning on, the automatic mode is activated. Once the instrument has self-leveled, the laser head will start rotating.

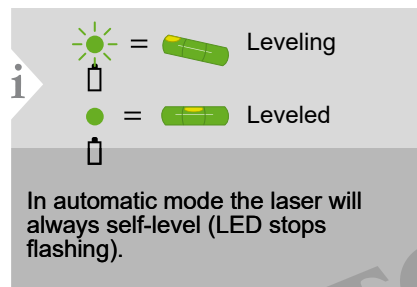

## Switching OFF



## Manual mode

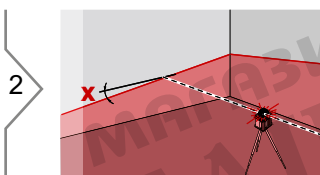
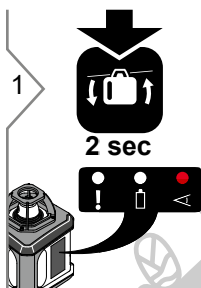

Incline the X-axis of the laser plane with the remote.

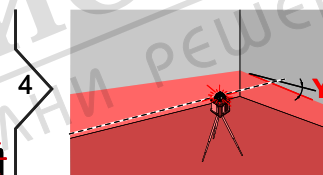
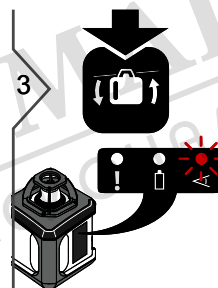

Incline the Y-axis of the laser plane with the remote.

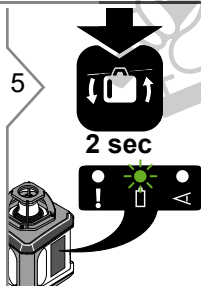

**Exit Manual mode**

**i**

In manual mode the laser beam will rotate even if the laser is not leveled. Manual mode can be used on inclined planes such as stairs, ceilings or anytime a manual grade setting is required.

# Operations

## H.I. Alert mode

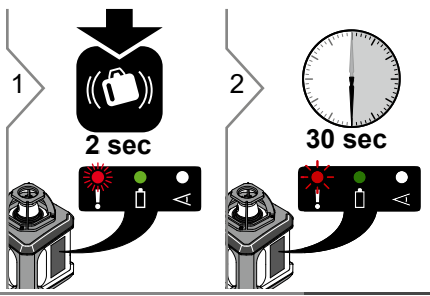

After 30 seconds the LED blinks slowly and the H.I. alert is activated.

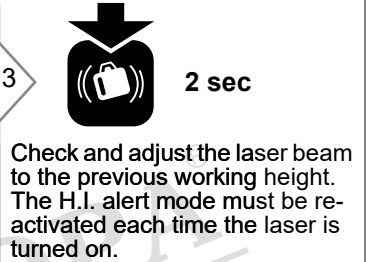
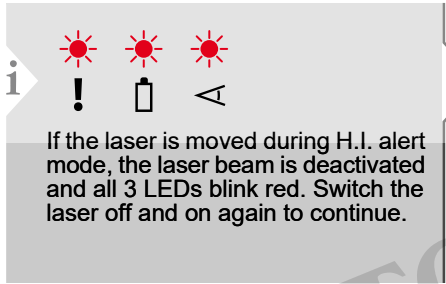

**i** The Elevation Alert or Height of Instrument function is designed to prevent incorrect work caused by sudden movement or settling of the tripod that would cause the laser to level at a lower height.



# Applications

## Rotating

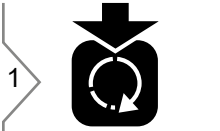

1

Start rotating

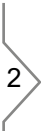

2

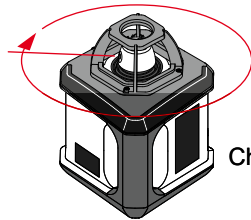

Change the rotation speed.

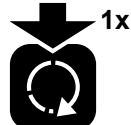

1x

0 rpm

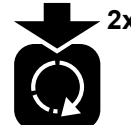

2x

300 rpm

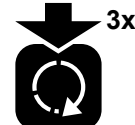

3x

450 rpm



4x

600 rpm

## Scanning



1

Start scanning



2

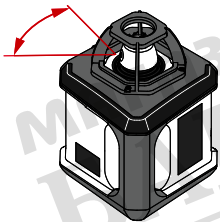

Change the scan angle.



1x



2x

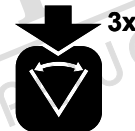





3x

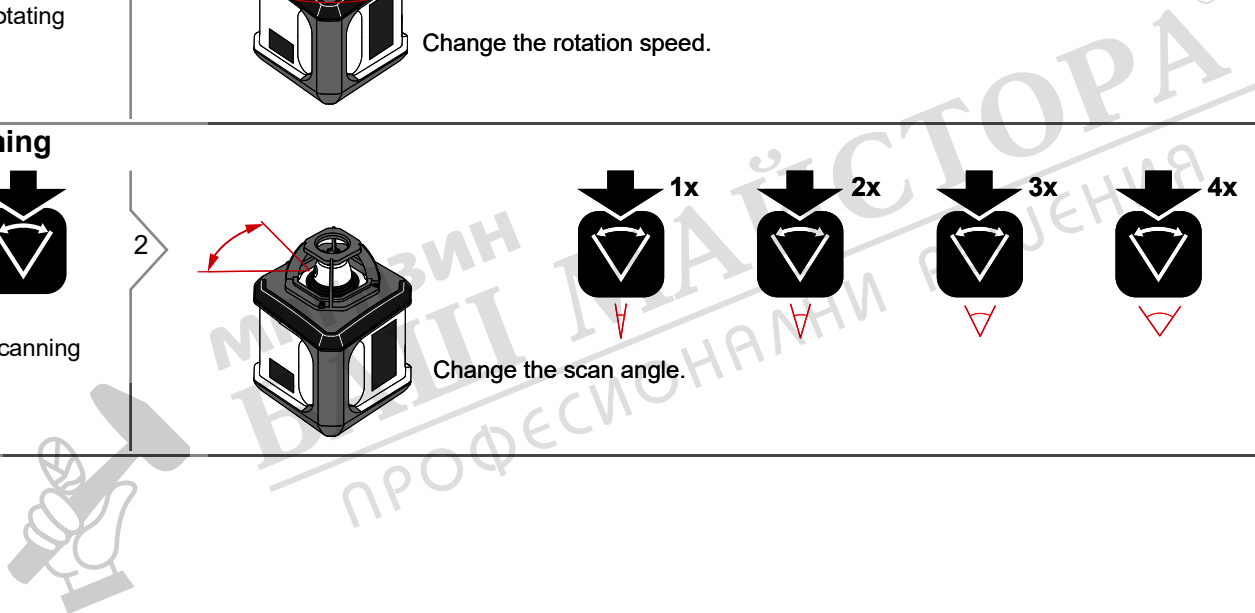

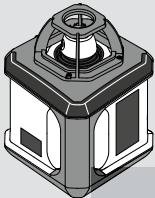
4x

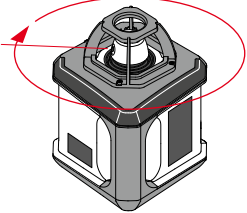
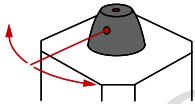
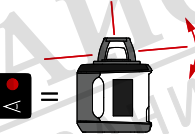
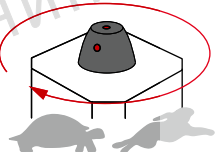
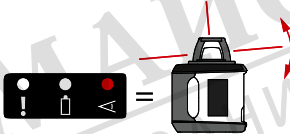
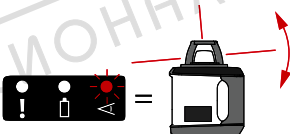
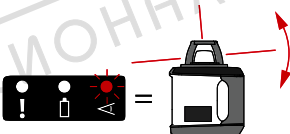
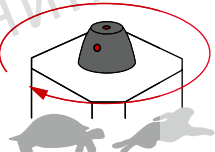
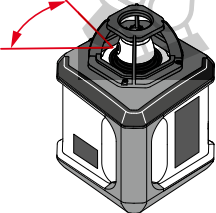
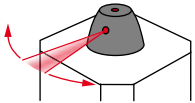
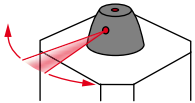
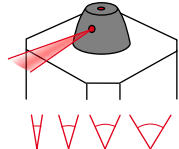
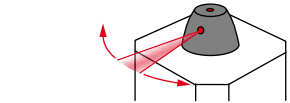
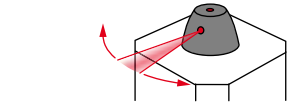
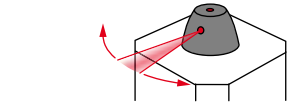
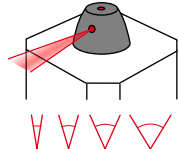

			
<p><b>Rotation Mode</b></p> 	<p><b>Automatic Mode</b></p> 		
<p><b>Manual Mode</b></p> 	<p><b>Manual Mode</b></p> 		
<p><b>Scan Mode</b></p> 	<p><b>Automatic Mode</b></p> 		
<p><b>Manual Mode</b></p> 	<p><b>Manual Mode</b></p> 		

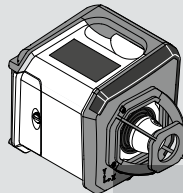
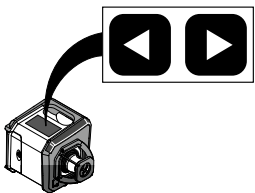
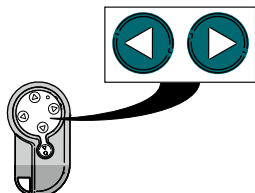
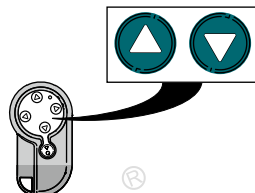
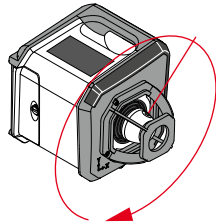
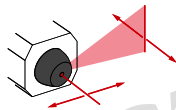
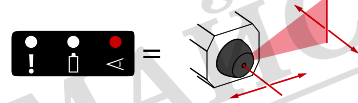
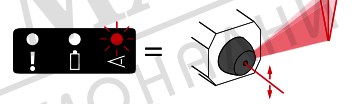
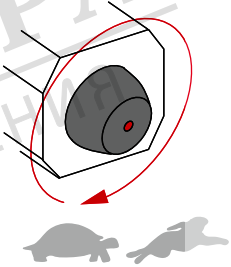
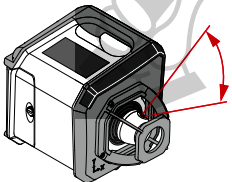
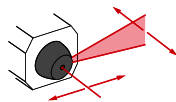
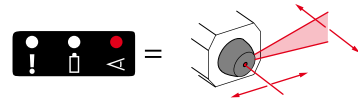
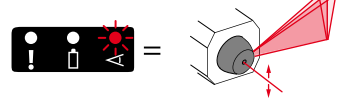
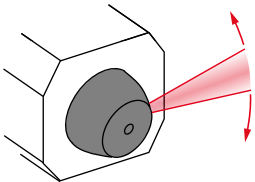
				
<p><b>Rotation Mode</b></p> 	<p><b>Automatic Mode</b></p>			
	<p><b>Manual Mode</b></p>			
				
<p><b>Scan Mode</b></p> 	<p><b>Automatic Mode</b></p>			
	<p><b>Manual Mode</b></p>			
				



# Alignment applications

## Level fixing points

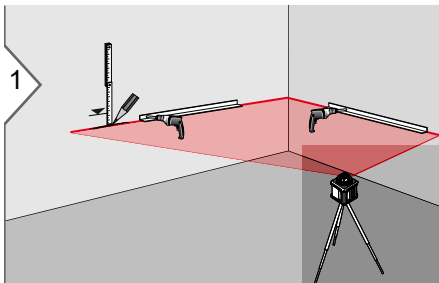

Switch on the laser. Adjust the height of the laser to known benchmark for the fixing points. Use automatic mode or H.I. alert mode and allow the laser to self-level.

## Water pipe assembly

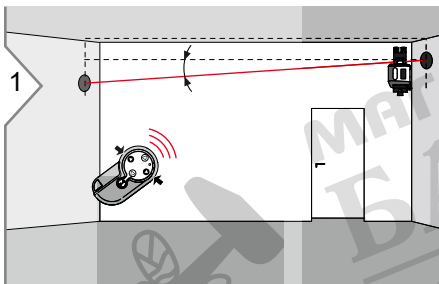

Mount laser with the wallmount to the wall. Switch to manual mode. Incline the laser beam to the reference.

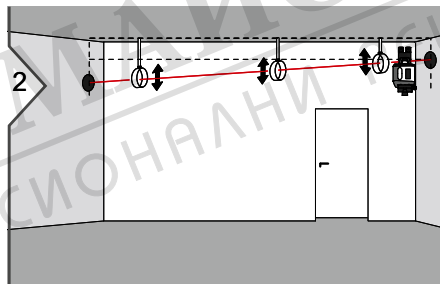

Adjust the tube clamps to the laser beam.

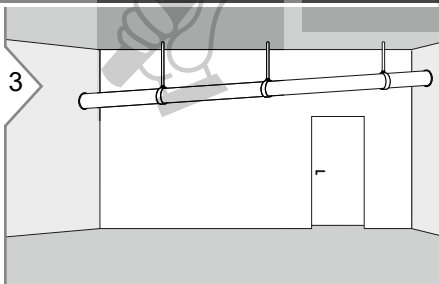

Mount and fix the water pipe.

## Alignment applications

### Floor leveling

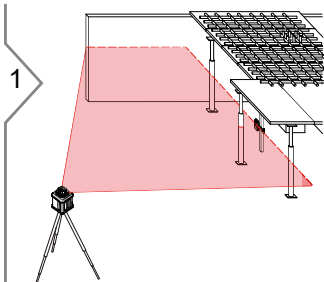

Switch on the laser. Use automatic mode or H.I. alert mode and allow the laser to self-level.

Mount receiver with clamp on the staff.

Pick up reference height.

Adjust height needed for floors.

Level supporting poles for floor.

### Formwork leveling

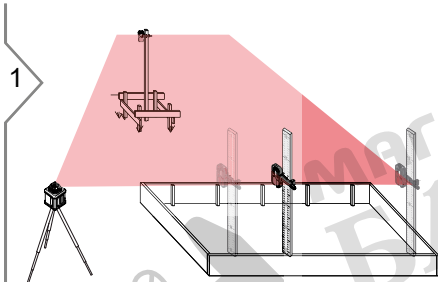

Switch on the laser. Use automatic mode or H.I. alert mode and allow the laser to self-level.

Mount receiver with clamp on the staff.

Pick up reference height.

Adjust height needed for formwork.

Level and adjust formwork.

## Checking the accuracy

### Level accuracy

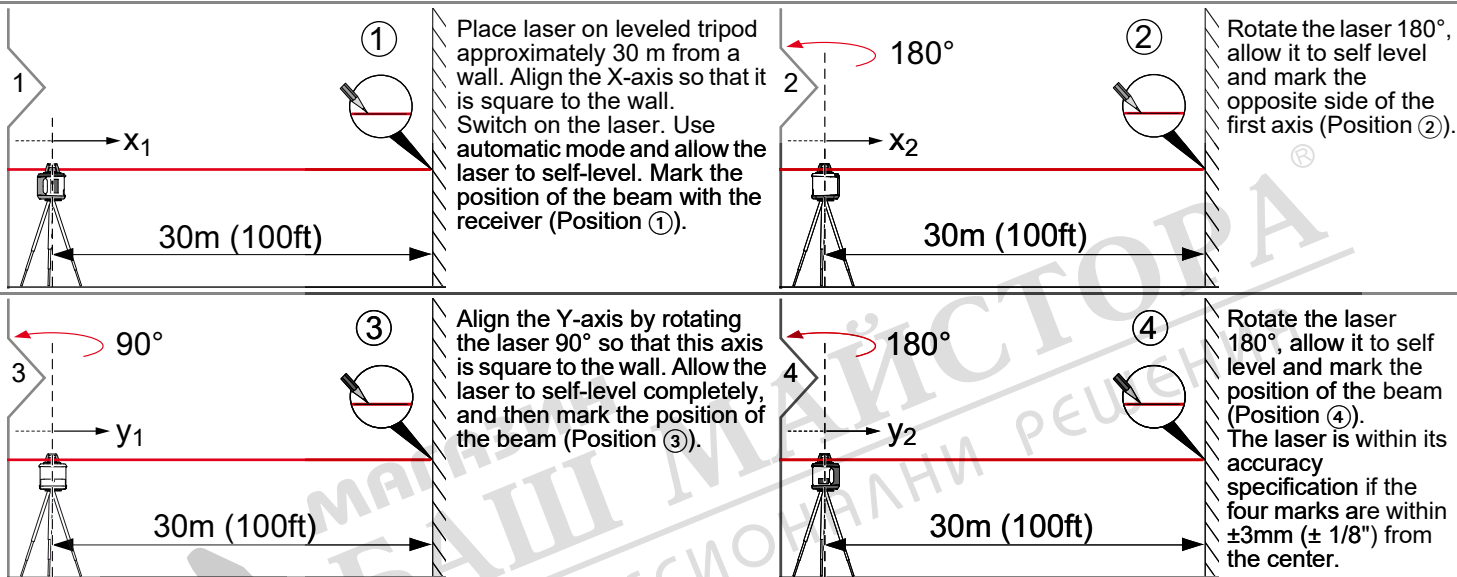

### Vertical accuracy

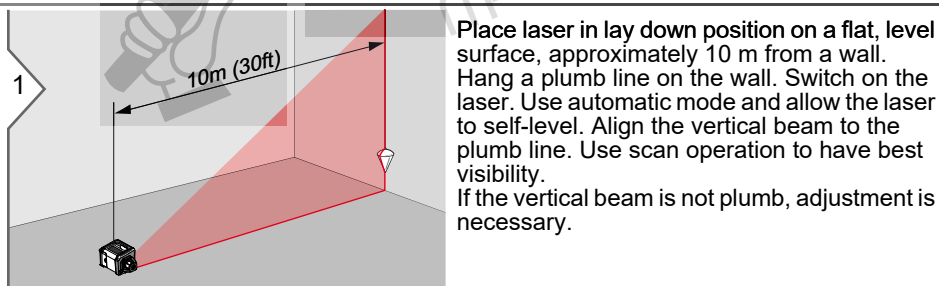

**i** Should the laser be outside of the specified tolerance, please contact a local dealer.

Rotary Laser	
<b>Operating Range (Rotating beam)</b>	200 m (656 ft) diameter, with receiver
<b>Operating Range (Plumb beam)</b>	up to 30m (100 ft)
<b>Self-leveling Accuracy*</b>	±1 mm at 10 m ±1/16" at 50 ft
<b>Self-leveling range</b>	±6°
<b>Rotation speeds</b>	0, 300, 450, 600 rpm
<b>Scan</b>	yes, 4 steps
<b>Laser type</b>	635 nm (red), < 1 mW
<b>Laser class</b>	2
<b>Dimension (H x W x D)</b>	156 x 154 x 197 mm 6.1 x 6.1 x 7.8 in
<b>Weight (with batteries)</b>	1.6 kg / 55 oz
<b>Batteries</b>	2x 1.5V LR20 (D)***
<b>Battery durability **</b>	60 hours**
<b>Temperature range:</b>	
- Storage	-20 to 70 °C -4 to 158 °F
- Operation	-10 to 50 °C 14 to 122 °F
<b>Protection class</b>	IP54 (dust- and splash water protected)
<b>Tripod Thread</b>	5/8"-11

Remote Control	
<b>Range</b>	up to 30m (100 ft)
<b>Batteries</b>	1x AA, 1.5V***
<b>Temperature range:</b>	
- Storage	-20 to 70 °C -4 to 158 °F
- Operation	-10 to 50 °C 14 to 122 °F

Receiver	
<b>Sensitivity (switchable)</b>	±1 mm / ±3 mm ±0.04 in / ±0.12 in
<b>Battery</b>	1x 6LR61, 9V***
<b>Temperature range:</b>	
- Storage	-20 to 70 °C -4 to 158 °F
- Operation	-10 to 50 °C 14 to 122 °F
<b>Protection class</b>	IP65 (dust tight and jet water protected)

\* Accuracy is defined at 25°C

\*\* Battery life is dependent upon environmental conditions

\*\*\* Leakage proof alkaline batteries strongly recommended

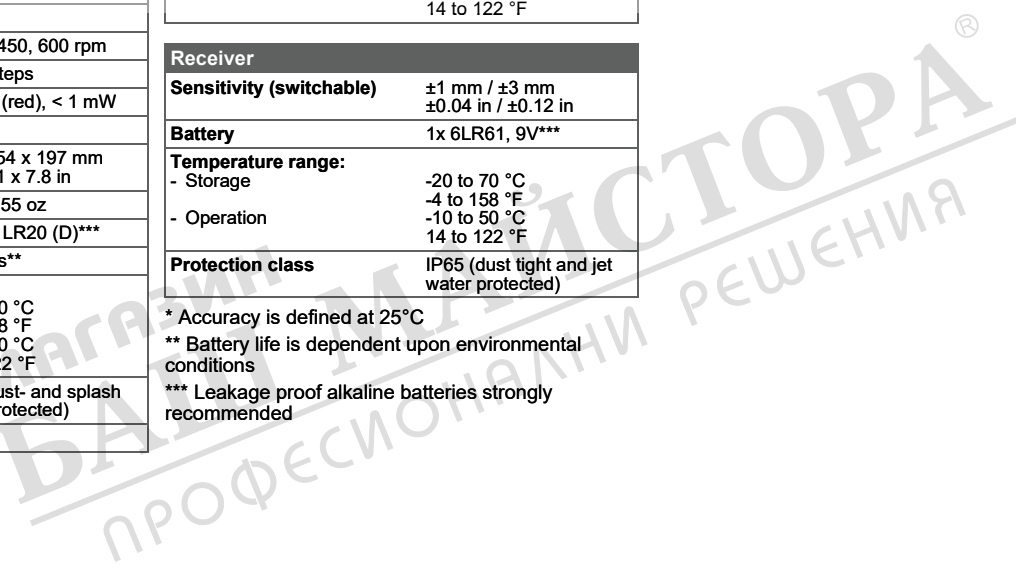

## Transport

### Transport in the field

When transporting the equipment in the field, always make sure that you

- either carry the product in its original transport container,
- or carry the tripod with its legs splayed across your shoulder, keeping the attached product upright.

### Transport in a road vehicle

Never carry the product loose in a road vehicle, as it can be affected by shock and vibration. Always carry the product in its transport container and secure it.

### Shipping

When transporting the product by rail, air or sea, always use the complete original packaging, transport container and cardboard box, or its equivalent, to protect against shock and vibration.

### Shipping, transport of batteries

When transporting or shipping batteries, the person in charge of the product must ensure that the applicable national and international rules and regulations are observed. Before transportation or shipping, contact your local passenger or freight transport company.

## Storage

### Product

Respect the temperature limits when storing the equipment, particularly in summer if the equipment is inside a vehicle. Refer to "Technical Data" for information about temperature limits.

### Alkaline Batteries

If the equipment is to be stored for a long time, remove the alkaline batteries from the product in order to avoid the danger of leakage.

## Cleaning and Drying

### Product and Accessories

- Blow dust off optical parts.
- Never touch the glass with your fingers.
- Use only a clean, soft, lint-free cloth for cleaning.
- Do not use other liquids; these may attack the polymer components.

### Damp Products

- Dry the product, the transport container, the foam inserts and the accessories at a temperature not greater than 40°C / 104°F and clean them.
- Do not repack until everything is completely dry.

## Safety Instructions

The person responsible for the instrument must ensure that all users understand these directions and adhere to them.

### Areas of responsibility

#### Responsibilities of the manufacturer of the original equipment:

Makita Corporation Anjo,  
Aichi 446-8502 Japan  
Internet: [www.makita.com](http://www.makita.com)

The company above is responsible for supplying the product, including the User Manual in a completely safe condition.

The company above is not responsible for third party accessories.

#### Responsibilities of the person in charge of the instrument:

- To understand the safety instructions on the product and the instructions in the User Manual.
- To be familiar with local safety regulations relating to accident prevention.
- Always prevent access to the product by unauthorised personnel.



### Permitted use

- The instrument casts a horizontal laser plane for the purposes of alignment.
- The unit can be set up on its own base plate, wallmount or on a tripod.
- The laser beam can be detected by means of a laser detector.
- This product is intended for indoor use and applications.

### Limits of use

- ⓘ Refer to section "Technical data". The device is designed for use in areas permanently habitable by humans. Do not use the product in explosion hazardous areas or in aggressive environments.

### Prohibited use

- Using the product without instruction
- Use outside of the intended limits.
- Disabling safety systems.
- Removal of hazard notices.
- Opening the product using tools, for example screwdriver, unless this is specifically permitted for certain functions.
- Modification or conversion of the product.
- Use after misappropriation.
- Use of products with obviously recognizable damages or defects.
- Use with accessories from other manufacturers without express approval.
- Inadequate safeguards at the work site, for example when using on or near roads.
- Deliberate dazzling of third parties.
- Controlling of machines, moving objects or similar monitoring application without additional control and safety installations.

## Safety Instructions

### Noise emissions (laser receiver)

#### CAUTION

The A-weighted sound pressure level of the signal sound is  $> 80$  db(A) at a distance of one meter.

**Do not hold the laser receiver directly to your ear!**

### Hazards in use

#### WARNING

Watch out for erroneous measurement results if the product has been dropped or has been misused, modified, stored for long periods or transported.

Carry out periodic test measurements.

Particularly after the instrument has been subject to abnormal use, and before, during and after important measurements. Refer to section "Checking the Accuracy".

#### WARNING

Because of the risk of electrocution, it is very dangerous to use grade rods and staffs in the vicinity of electrical installations such as power cables or electrical railways.

#### Precautions:

Keep at a safe distance from electrical installations. If it is essential to work in this environment, first contact the safety authorities responsible for the electrical installations and follow their instructions.

#### WARNING



If the product is used with accessories, for example masts, staffs, poles, you may increase the risk of being struck by lightning.

#### Precautions:

Do not use the product in a thunderstorm.

#### WARNING

Inadequate securing of the working site can lead to dangerous situations, for example in traffic, on building sites, and at industrial installations.

#### Precautions:

Always ensure that the working site is adequately secured. Adhere to the regulations governing safety and accident prevention and road traffic.

#### WARNING

If the accessories used with the product are not properly secured and the product is subjected to mechanical shock, for example blows or falling, the product may be damaged or people may sustain injury.

#### Precautions:

When setting-up the product, make sure that the accessories are correctly adapted, fitted, secured, and locked in position. Avoid subjecting the product to mechanical stress.

#### WARNING

Changes or modifications not expressly approved could void the user's authority to operate the equipment.

#### CAUTION

Never attempt to repair the product yourself. In case of damage, contact a local dealer.

### Disposal

#### CAUTION

Flat batteries must not be disposed of with household waste. Care for the environment and take them to the collection points provided in accordance with national or local regulations.

The product must not be disposed with household waste.

Dispose of the product appropriately in accordance with the national regulations in force in your country.



Adhere to the national and country specific regulations.

Product specific treatment and waste management can be downloaded from our homepage.

## Safety Instructions

### Electromagnetic Compatibility (EMC)

#### WARNING

The device conforms to the most stringent requirements of the relevant standards and regulations.

Yet, the possibility of causing interference in other devices cannot be totally excluded.



### FCC statement (applicable in U.S.)

This equipment has been tested and found to comply with the limits for a Class B digital device, pursuant to part 15 of the FCC Rules. These limits are designed to provide reasonable protection against harmful interference in a residential installation. This equipment generates, uses and can radiate radio frequency energy and, if not installed and used in accordance with the instructions, may cause harmful interference to radio communications.

However, there is no guarantee that interference will not occur in a particular installation. If this equipment does cause harmful interference to radio or television reception, which can be determined by turning the equipment off and on, the user is encouraged to try to correct the interference by one or more of the following measures:

- Reorient or relocate the receiving antenna.
- Increase the separation between the equipment and receiver.
- Connect the equipment into an outlet on a circuit different from that to which the receiver is connected.
- Consult the dealer or an experienced radio/TV technician for help.

# Safety Instructions

## Laser classification

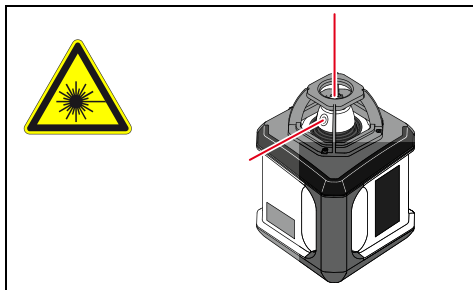

The device produces visible laser beams, which are emitted from the instrument:  
It is a Class 2 laser product in accordance with:

- IEC60825-1 : 2007 „Radiation safety of laser products“

### Laser Class 2 products:

Do not stare into the laser beam or direct it towards other people unnecessarily. Eye protection is normally afforded by aversion responses including the blink reflex.

### **⚠ WARNING**

Looking directly into the beam with optical aids (e.g. binoculars, telescopes) can be hazardous.

### **⚠ CAUTION**

Looking into the laser beam may be hazardous to the eyes.

## Labelling

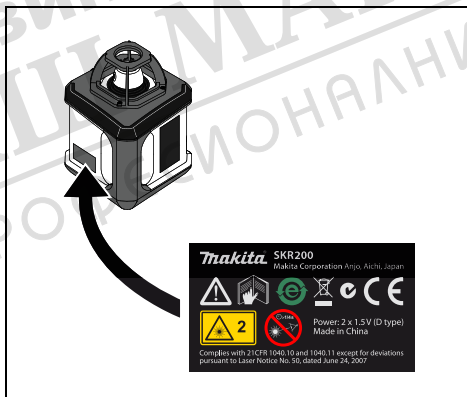
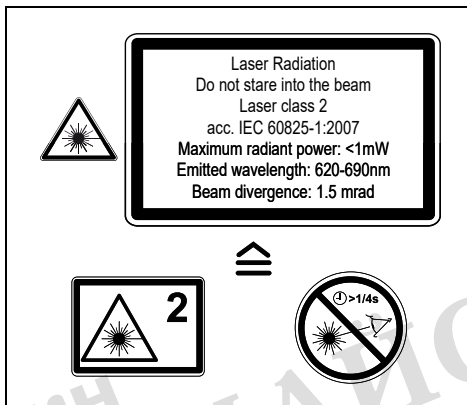

Subject to change (drawings, descriptions and technical data) without prior notice.