

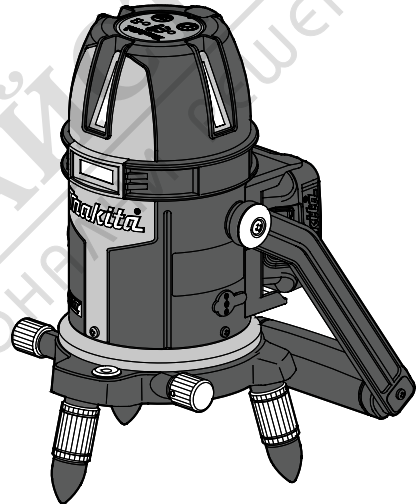

INSTRUCTION MANUAL



# Rechargeable Green Multi Line Laser

SK312GD  
SK209GD



 Read before use.



## CONTENTS

SPECIFICATIONS	3
Symbols	4
Intended use	4
Laser Beam Related Safety Standards	4
Safety Declaration	5
Noise Related Safety Standards	6
Safety Warnings	7
NAMES OF PARTS	13
Optional Accessories	13
Installing or removing battery cartridge	14
Battery Protection System	15
Using the USB adapter (optional accessory)	16
Using the Multi Line Laser	17
Installing the Multi Line Laser	17
Operating the power switch	18
Brightness selection	18
Line beam mode selection	19
CHECKING THE ACCURACY	21
Checking the horizontal line	21
Checking the plumbing point and vertical line	22
Checking the 180°vertical line	23
Checking the 90°vertical line	24
MAINTENANCE	26



# SPECIFICATIONS

	SK312GD	SK209GD
Laser source	Line beam: Green semiconductor laser Lower dot beam: Red semiconductor laser	
Laser wavelength	510 to 530 nm (lower dot beam 650 to 660 nm)	
Laser output	Each 1 mW or less (CLASS 2 LASER PRODUCT) IEC 60825-1:2014	
Laser line emission angle	Vertical 130°±10% 180° vertical line 240°±20% Horizontal 110°±10%	Vertical 130°±10% Horizontal 110°±10%
Laser dot diameter	1.5 mm / 1 m (lower dot beam)	
Laser beam selection	Horizontal line / Horizontal/vertical line / 3-vertical line/horizontal line	Horizontal line / 2-vertical line / 2-vertical line/horizontal line
Brightness selection	3 modes (constant pulse) Eco mode/ Normal mode / Bright mode	
Indication method	Automatic vertical line indication by gimbal mechanism	
Vertical line indication range	±2° (alarm given by light off outside range)	
Horizontal fine-adjustment range	Entire circumference	
Control method	Magnet damper method	
Accuracy	Emitted laser	±1 mm / 10 m *(Before shipment from factory)
	2-vertical line	90°±0.01°
Power supply	Makita battery cartridge / USB adapter	
Rated Voltage	D.C.10.8V - 12Vmax, D.C. in 5V	
Operating time (when BL1015 or BL1016 is used)	At 3-vertical line/horizontal line Bright mode: Approx. 10 h Normal mode: Approx. 16 h Eco mode: Approx. 21 h	At 2-vertical line/horizontal line Bright mode: Approx. 15 h Normal mode: Approx. 23 h Eco mode: Approx. 28 h
Operating temperature range	-10°C to +40°C (14°F to 104°F)	
ESD protective measures	Level: 4 (IEC61000-4-2)	
Dimensions	87 mm (dia.) x 230 mm (height) (excluding protrusions)	
Battery cartridge	BL1015, BL1016, BL1020B, BL1021B, BL1040B, BL1041B	
Net weight	1.5 kg - 1.6 kg	
Tripod screw	W 5/8"	

**NOTE:** Use the product in the following operating environment.

- Indoor use
- Altitude: up to 2000m
- Humidity: Maximum relative humidity 80% temperature rise to 31°C (87.8°F) decreasing linearly to 50% relative humidity at 40°C (104°F)
- Pollution degree 3

\* Due to our continuing program of research and development, the specifications herein are subject to change without notice.

\* Specification values vary according to operating environment conditions and other factors.

\* Specifications and battery cartridge may differ from country to country.

\* The weight may differ depending on the battery cartridge. The lightest and heaviest combination, according to EPTA-Procedure 01/2014, are shown in the table.

**NOTE:** When used at 0°C or lower temperatures, the laser lines are weak just after turning the power on. Turn the laser ON and wait for it to stabilize.

## Symbols

The definitions below describe the level of severity for each signal word and the meaning of each symbol used in this manual.

Please read the manual and pay attention to these symbols.



: Read instruction manual.



: Laser warning



**DANGER**

: This indicates the risk of death or frequent serious injury.



: Only for EU countries

Do not dispose of electric equipment or battery pack together with household waste material! In observance of the European Directives, on Waste Electric and Electronic Equipment and Batteries and Accumulators and Waste Batteries and Accumulators and their implementation in accordance with national laws, electric equipment and batteries and battery pack(s) that have reached the end of their life must be collected separately and returned to an environmentally compatible recycling facility.



**WARNING**

: This indicates the risk of serious injury.



**CAUTION**

: This indicates the risk of light injury.

**NOTICE  
NOTE**

: This indicates the risk of malfunction or damage to property.



: This indicates the risk of electric shock.



: This indicates the risk of fire.

## Intended use

The measuring tool is intended for levelling jobs with the use of horizontal lines, vertical lines and the plumb point.

## Laser Beam Related Safety Standards

This product complies with the following standards:

• IEC 60825-1:2014



LASER RADIATION

DO NOT STARE INTO BEAM

CLASS 2 LASER PRODUCT

MAXIMUM OUTPUT POWER: P=1 mW

Wavelength:  $\lambda=510 \sim 530\text{nm} / 650 \sim 660\text{nm}$

Pulse: 150 to 600ns / 1.5 to 1.7 MHz is controlled at 60 to 160 $\mu\text{s} / 5 \text{ kHz}$

( $\lambda=510 \sim 530 \text{ nm}$ )

## CAUTION

Use of controls or adjustments or performance of procedures other than those specified herein may result in hazardous radiation exposure.

## Safety Declaration

This product complies with the following standards:

- EN61326-1: Electrical equipment for measurement, control and laboratory use – EMC requirements
- IEC61010-1:2010 (3rd Edition) Safety requirements for electrical equipment for measurement, control, and laboratory use

The usage conditions of this product for compliance with this standard are as follows.



## **CAUTION - When installing the BL1040B/BL1041B battery cartridge (This caution is an explanation for labels used on this product.)**

Before installing the battery on this product and placing on a floor or table, lower the handle and check the product does not fall over.

- FCC Part15 Subpart B: Federal Communications Commission (FCC), Equipment authorization of unintentional radiators
- ICES003: Canada ICE regulations



## Noise Related Safety Standards

- FCC Part15 SubpartB/ICES 003

### CAUTION

Changes or modifications not expressly approved by the party responsible for compliance could void the user's authority to operate the equipment.

### NOTE:

This equipment has been tested and found to comply with the limits for a Class B digital device, pursuant to part 15 of the FCC Rules.

These limits are designed to provide reasonable protection against harmful interference in a residential installation.

This equipment generates, uses and can radiate radio frequency energy and, if not installed and used in accordance with the instructions, may cause harmful interference to radio communications.

However, there is no guarantee that interference will not occur in a particular installation.

If this equipment does cause harmful interference to radio or television reception, which can be determined by turning the equipment off and on, the user is encouraged to try to correct the interference by one or more of the following measures:

- Reorient or relocate the receiving antenna.
- Increase the separation between the equipment and receiver.
- Connect the equipment into an outlet on a circuit different from that to which the receiver is connected.
- Consult the dealer or an experienced radio/TV technician for help.

If the equipment is used in a manner not specified by the manufacturer, the protection provided by the equipment may be impaired.



## Safety Warnings

### WARNING

**Read all safety warnings, instructions, illustrations and specifications provided with the product.** Failure to follow all instructions listed below may result in electric shock, fire and/or serious injury.

**Save all warnings and instructions for future reference.**

### WARNING - Laser safety

- Do not look directly into the laser beam on optical instruments.
  - Directly looking at the laser beam by telescopic optics, magnifying glass or similar instruments is dangerous.
  - Do not stare directly at the laser beam.
  - Avoid locating the path of the laser beam at eye height.
  - Do not enter the path of the laser beam.
  - Do not place reflective objects in the path of the laser beam.
  - Do not point the laser beam at other persons.
- Continuously looking at laser beams may damage your eyes. If your eyes might be impaired, immediately seek treatment by a physician.

### WARNING - Work area safety

1. **Keep work area clean and well lit.**  
Cluttered or dark areas invite accidents.
-  2. **Do not operate the product in explosive atmospheres, such as in the presence of flammable liquids, gases or dust.**  
Products create sparks which may ignite the dust or fumes.
3. **Keep children and bystanders away while operating the product.**  
Distractions can cause you to lose control.

### WARNING - Electrical safety

-  1. **Avoid body contact with earthed or grounded surfaces such as pipes, radiators, ranges and refrigerators.**  
There is an increased risk of electric shock if your body is earthed or grounded.
2. **Do not expose the product to rain or wet conditions.**  
Water entering the product will increase the risk of electric shock.



3. **Do not short-circuit terminals on the product.**

Do not allow pins or wire to get inside the USB terminal. This may cause a short-circuit, which may result in the risk of smoke emission or ignition.



4. **Do not hold the power supply cable by your mouth.**

Doing so might cause an electric shock.

### **WARNING - Storage**

**Properly store the charging tool when it is not in use.** Store it in a safe location out of the reach of children and in a dry location under lock and key.

### **WARNING - Battery product use and care**

1. **Recharge only with the charger specified by the manufacturer.** A charger that is suitable for one type of battery pack may create a risk of fire when used with another battery pack.
2. **Use the product only with specifically designated battery packs.** Use of any other battery packs may create a risk of injury and fire.
3. **When battery pack is not in use, keep it away from other metal objects, like paper clips, coins, keys, nails, screws or other small metal objects, that can make a connection from one terminal to another.** Shorting the battery terminals together may cause burns or a fire.
4. **Under abusive conditions, liquid may be ejected from the battery; avoid contact. If contact accidentally occurs, flush with water. If liquid contacts eyes, additionally seek medical help.** Liquid ejected from the battery may cause irritation or burns.
5. **Do not use a battery pack or product that is damaged or modified.** Damaged or modified batteries may exhibit unpredictable behaviour resulting in fire, explosion or risk of injury.
6. **Do not expose a battery pack or product to fire or excessive temperature.** Exposure to fire or temperature above 130 °C may cause explosion.
7. **Follow all charging instructions and do not charge the battery pack or product outside the temperature range specified in the instructions.**  
Charging improperly or at temperatures outside the specified range may damage the battery and increase the risk of fire.
8. **Use Makita battery cartridge only with products specified by Makita.**

## **WARNING - Maintenance**

1. **Have the product serviced by a qualified repair person using only identical replacement parts.** This will ensure that the safety of the product is maintained.
2. **Never service damaged battery packs.** Service of battery packs should only be performed by the manufacturer or authorized service providers.
3. **Follow instruction for changing accessories.**
4. **Do not disassemble, repair, modify or retrofit this product, charger or battery.** Doing so might cause ignition or abnormal operation, which may result in injury.



5. **Inspect this product for damaged parts.** If this product is operating abnormally or malfunctioning, immediately stop use. Continued use of this product in this condition might lead to smoke emission, ignition, electric shock, or injury.

<Examples of Abnormalities and Malfunction>

- x Power cable and power plug are abnormally hot.
- x The power cable has deep scratches or is deformed.
- x Power turns ON and OFF when the power cable is moved.
- x There is a burning smell.
- x There is a tingling feeling of electricity.

If you sense a malfunction, such as this product not functioning even after turning the power switch ON, immediately remove the battery and ask the store of purchase or a Makita authorized service center for inspection and repair.

6. **This product complies with relevant safety standard.** Do not modify or retrofit it.
7. **If repair is performed by a person without specialist knowledge and repair skills, not only will the performance of this product not be fully demonstrated but this might also result in accident or injury.**

## **WARNING - Additional safety**

**Use the correct accessories.** Use only accessories recommended in this User's Manual and in Makita catalogs. Do not use other accessories since this might result in malfunction, accident or injury.

## PRECAUTIONS

1. Check the accuracy of the product each time before starting your work. For details, see "CHECKING THE ACCURACY".
2. Avoid heavy shake or impact on the product.  
The product is designed in an impact-resistant structure. However excessive impact may cause degradation in performance. After heavy impact, an accuracy check should be carried out.
3. Before moving this product, lock this product by turning the power OFF. After work is finished, turn the power switch OFF. Then the product is locked internally.
4. If there is an apparent abnormality, do not use this product. Immediately stop work, and contact the store of purchase or the nearest Makita sales office.
5. If the laser is not emitted after turning the power ON, lightly shake this product a few times.  
If the laser is not emitted even after shaking this product lightly a few times, immediately stop work, and contact the store of purchase or the nearest Makita sales office.
6. When the power is turned ON, the product emits the laser beam in the same mode that was turned OFF last time. Operate the switch with keeping the laser beam away from your eyes.
7. In dark area, reflections may be seen besides the regular laser lines.
8. Do not use the product if condensation is found on it.  
Do not turn the power ON. Leave the product until condensation naturally disappears.
9. Do not use the laser receiver near the point the laser lines cross each other. The laser receiver does not detect near such a point.
10. When transporting this product, put it in its case.
11. When storing, put the product in its case. The storage area should be away from heat, moisture, vibration and dust.
12. Clean the glass at exit opening of the laser beam using soft cloth to keep performance.
13. When the product is dirty, wipe it clean with a soft, dry cloth. If the dirt is stubborn, use a cloth moistened with water and wrung firmly. Then, wipe off any water again with a soft, dry cloth. Do not use alcohol, benzene, paint thinner, or other volatile solvents. (Doing so might cause discoloring, deformation, alteration or other abnormalities.)
14. Do not wash the product. It may cause malfunction.

15. Never modify or retrofit this product. Disassembly, modification or retrofitting this product may cause malfunction or an electric shock.
16. When this product is not used for a long time, remove the battery.
17. With regards to safety education, the user must fully understand the nature and danger of laser beams.
18. The product is not intended for use by persons including children with reduced physical, sensory or mental capabilities, or lack of experience and knowledge. Young children should be supervised to ensure that they do not play with the product.

### **Important safety instructions for battery cartridge**

1. **Before using battery cartridge, read all instructions and cautionary markings on (1) battery charger, (2) battery, and (3) product using battery.**
2. **Do not disassemble battery cartridge.**
3. **If operating time has become excessively shorter, stop operating immediately. It may result in a risk of overheating, possible burns and even an explosion.**
4. **If electrolyte gets into your eyes, rinse them out with clear water and seek medical attention right away. It may result in loss of your eyesight.**
5. **Do not short the battery cartridge:**
  - (1) **Do not touch the terminals with any conductive material.**
  - (2) **Avoid storing battery cartridge in a container with other metal objects such as nails, coins, etc.**
  - (3) **Do not expose battery cartridge to water or rain.**  
**A battery short can cause a large current flow, overheating, possible burns and even a breakdown.**
6. **Do not store the tool and battery cartridge in locations where the temperature may reach or exceed 50 °C (122 °F).**
7. **Do not incinerate the battery cartridge even if it is severely damaged or is completely worn out. The battery cartridge can explode in a fire.**
8. **Be careful not to drop or strike battery.**

9. **Do not use a damaged battery.**
10. **The contained lithium-ion batteries are subject to the Dangerous Goods Legislation requirements.**

For commercial transports e.g. by third parties, forwarding agents, special requirement on packaging and labeling must be observed.

For preparation of the item being shipped, consulting an expert for hazardous material is required.

Please also observe possibly more detailed national regulations.

Tape or mask off open contacts and pack up the battery in such a manner that it cannot move around in the packaging.

11. **Follow your local regulations relating to disposal of battery.**

**SAVE THESE INSTRUCTIONS.**

### CAUTION

#### **Only use genuine Makita batteries.**

Use of non-genuine Makita batteries, or batteries that have been altered, may result in the battery bursting causing fires, personal injury and damage. It will also void the Makita warranty for the Makita tool and charger.

### **Tips for maintaining maximum battery life**

1. **Charge the battery cartridge before completely discharged. Always stop tool operation and charge the battery cartridge when you notice less tool power.**
2. **Never recharge a fully charged battery cartridge. Overcharging shortens the battery service life.**
3. **Charge the battery cartridge with room temperature at 10 °C - 40 °C (50 °F - 104 °F). Let a hot battery cartridge cool down before charging it.**



## NAMES OF PARTS

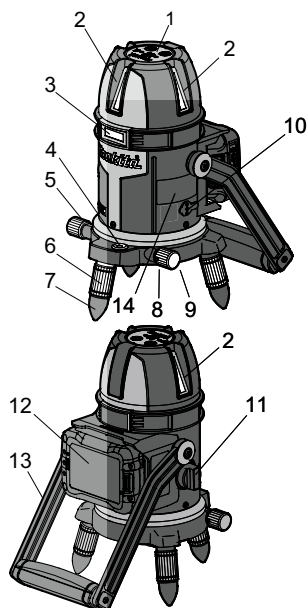

1. Operation panel
2. Vertical laser beam exit window
  - SK312GD: 3 parts
  - SK209GD: 2 parts
3. Horizontal laser beam exit window
4. Circular level
5. Rotation fine adjustment knob
6. Adjustment screw leg
7. Rubber foot cap
8. Lower laser beam exit port (base)
9. External tripod mounting screw hole (base)
10. DC jack cover
11. Power switch
12. Battery (optional accessory)
13. Handle
14. CAUTION LABEL

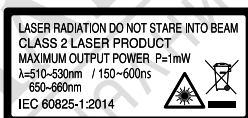

## Optional Accessories

For details of options, either refer to the catalog or inquire at the store of purchase or a Makita sales office.

**⚠CAUTION:** These accessories or attachments are recommended for use with your Makita tool specified in this manual. The use of any other accessories or attachments might present a risk of injury to persons. Only use accessory or attachment for its stated purpose.

If you need any assistance for more details regarding these accessories, ask your local Makita Service Center.

- Makita genuine battery and charger
- USB adapter
- Power supply cable
- Hand strap
- Laser Receiver LDG-3
- Wall mount
- Tripod
- Shoulder strap
- Laser viewing glass
- Storage case

**NOTE:** Some items in the list may be included in the tool package as standard accessories. They may differ from country to country.

## Installing or removing battery cartridge

### ⚠ CAUTION

- Always be sure that the tool is switched off and the battery cartridge is removed before adjusting or checking function on the tool.
- Always switch off the tool before installing or removing of the battery cartridge.
- Hold the tool and the battery cartridge firmly when installing or removing battery cartridge. Failure to hold the tool and the battery cartridge firmly may cause them to slip off your hands and result in damage to the tool and battery cartridge and a personal injury.

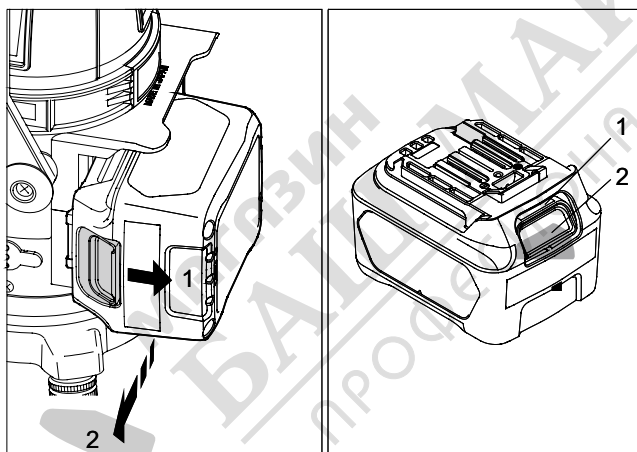

1. Red-colored section
2. Button

To remove the battery cartridge, slide it from the tool while sliding the button on the front of the cartridge.

To install the battery cartridge, align the tongue on the battery cartridge with the groove in the housing and slip it into place. Insert it all the way until it locks in place with a little click. If you can see the red indicator on the upper side of the button, it is not locked completely.

## CAUTION

- Always install the battery cartridge fully until the red indicator cannot be seen. If not, it may accidentally fall out of the tool, causing injury to you or someone around you.
- Do not install the battery cartridge forcibly. If the cartridge does not slide in easily, it is not being inserted correctly.

## Battery Protection System

The battery is provided with a protection system for automatically turning output OFF to extend the life of the battery. This occurs due to the battery protection system, and is not a malfunction.



Operation panel

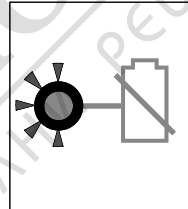

Battery indicator

- If the battery is about to run out during use of the product, the battery indicator on the operation panel lights. If use is continued in this state, the laser beam will go out.
- The battery indicator may indicate different remaining capacity from actual capacity depending on conditions of use, air temperature and other factors.

### **NOTE: To ensure prolonged battery use**

- Do not recharge fully charged batteries.
- Charge batteries within an ambient temperature range of 10°C to 40°C (50°F to 104°F).
- We recommend inserting batteries that have heated up immediately after use, for example, into the charger and allowing them to cool down before charging them.

## Using the USB adapter (optional accessory)

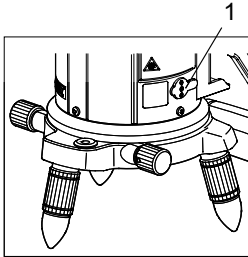

1: DC jack cover

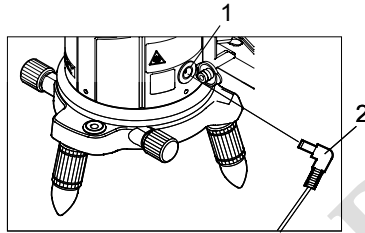

1: DC jack  
2: DC jack plug

1. Make sure that the product is turned OFF and remove the DC jack cover. Then, connect the DC jack plug of the power supply cable to the DC jack.
2. Connect the battery to the USB adapter.
3. Turn the power switch on the USB adapter ON, then turn the power switch on this product ON.

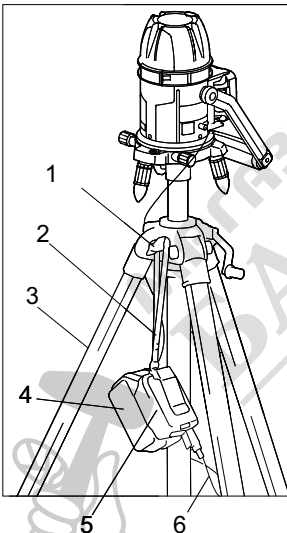

\* When using the USB adapter with a tripod (optional accessory), install the hand strap (optional accessory) on the USB adapter. With the tripod fixing screw firmly fixed in place, hook the hand strap onto the fixing screw as shown in the figure. If the fixing screw is loose, the USB adapter might fall, and this might cause it to malfunction, break the power supply cable or cause the USB terminals or DC jack to malfunction.

- 1: Fixing screw
- 2: Hand strap
- 3: Tripod
- 4: Battery
- 5: USB adapter
- 6: Power supply cable

### NOTICE

- The battery cannot be charged by the USB adapter.
- Before using the USB adapter, read its instruction manual.

## Using the Multi Line Laser

### 1. Installing the Multi Line Laser

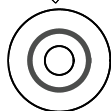
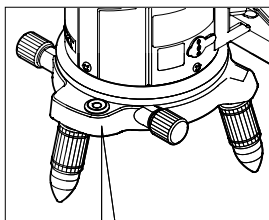

Circular level

Set this product on a level surface. Turn the adjustment screw leg so that the bubble in the circular level comes to the center of the red circle.

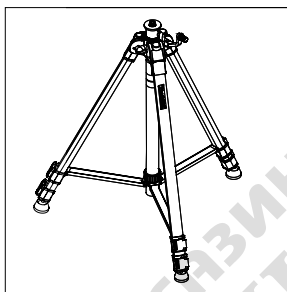

When using the tripod, first set down the tripod. Then mount the line laser on it. Extend or retract the legs of the tripod so that the bubble in the level comes to the center of the red circle.

#### **WARNING**

1. Do not place the product or USB adapter at locations where there is the risk of fall.
2. Before installing the battery on this product and placing on a floor or table, lower the handle and check the product does not fall over.

## 2. Operating the power switch

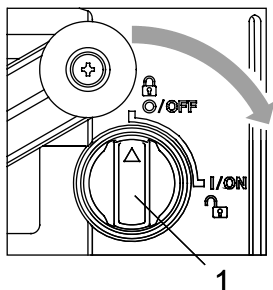

1. Power switch

### [Power ON]

Turn the power switch to the "I/ON" side. The laser beam is emitted. The laser beam is emitted in the mode that was active when the product was turned OFF last time.

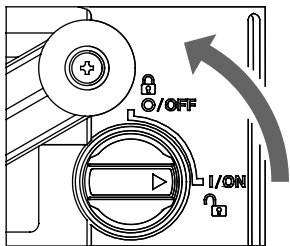

### [Power OFF]

Turn the power switch to the "O/OFF" side. The power turns OFF, and the pendulum inside is locked. After turning the power OFF, disconnect the battery or DC jack.

## 3. Brightness selection

Select the brightness of the emitted line beam by the brightness selection switch on the operation panel.

When the power is turned ON, the laser beam is emitted in the Bright mode.



Brightness selection switch

**Bright:** The line beam is brighter in this mode.

**Normal:** Brightness is between the Eco and Bright modes.  
This is the optimum mode when using the receiver.

**Eco:** Battery life lasts longer in this mode.

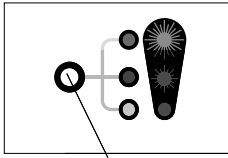

1: Brightness indicator

Bright

Mode

Brightness  
indicator

Bright

Red  
LED lit

Normal

LED out

Eco

Green  
LED lit

#### [Loopback switch system]



#### 4. Line beam mode selection

Select the line beam emission mode by the line selection switch on the operation panel.



Line selection switch

When the power is turned ON, the product emits the laser beam in the same mode of that was turned OFF last time.

SK312GD

#### [Loopback switch system]

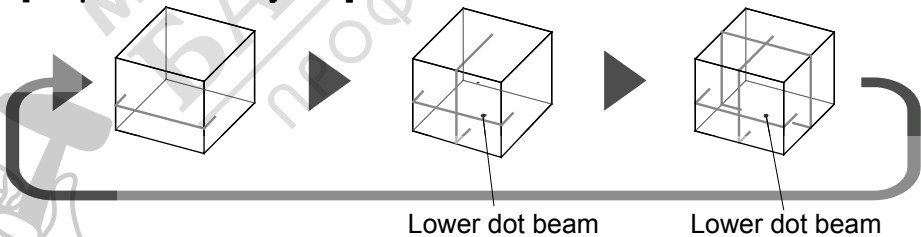

## SK209GD

### [Loopback switch system]

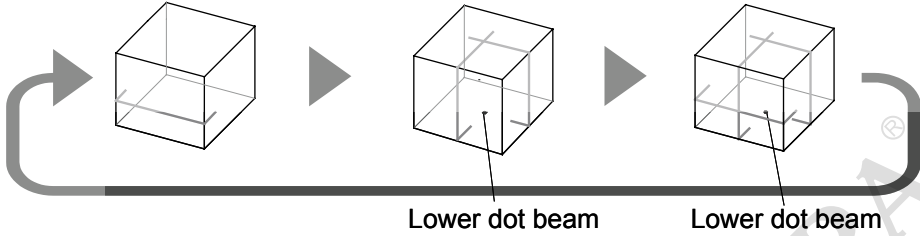

#### NOTE:

The height of the horizontal line beam can be easily adjusted by using the tripod (optional accessory).

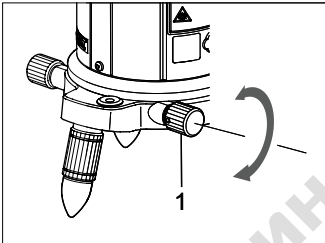

#### Fine-adjustment mechanism

It can be fine-adjusted from either side by turning the fine-adjustment knob.

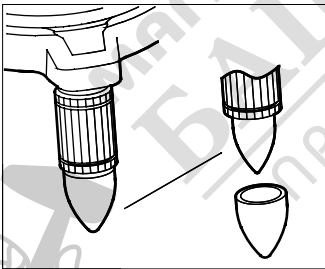

#### NOTE: About the rubber foot caps

Use the rubber caps to prevent the floor from being scratched or when the floor is slippery.

Rubber caps are supplied as standard. These can be removed before use on uneven surfaces such as concrete floor.

## CHECKING THE ACCURACY

- Should the line laser exceed the permissible difference during the checking, contact the store of purchase or a Makita authorized service center.

### 1. Checking the horizontal line

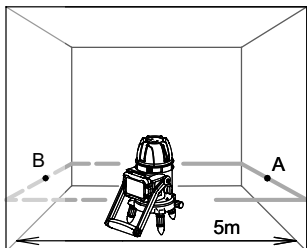

1. Place the line laser near the center of a room with approx. 5 m walls.
2. Adjust the line laser so that the bubble in the level comes to the center of the red circle.
3. Mark A at the position of the horizontal laser line on the wall.
4. Turn the line laser by 180° and mark B at the position of the horizontal laser line.

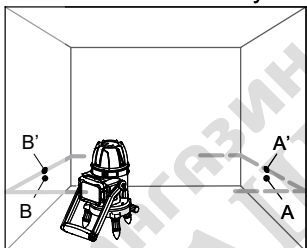

5. Move the line laser to the position 1 m away from the wall and adjust the bubble in the level.
6. Mark B' at the position of the horizontal laser line.
7. Turn the line laser by 180° and mark A' at the position of the horizontal laser line.  
The result is normal if the difference between A-A' and B-B' is within 1 mm.

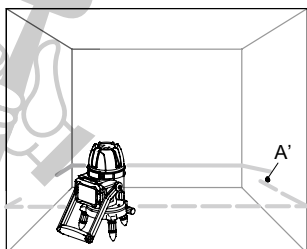

8. Rotate the line laser horizontally and measure the maximum difference in the horizontal laser line with A'.  
The result is normal if the deviation at point A' is within 1 mm.

## 2. Checking the plumbing point and vertical line

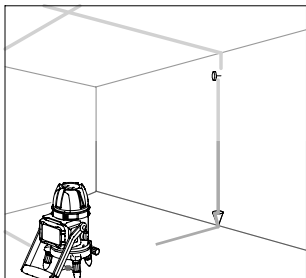

1. Set the "plumb" on the wall approx. 3 m above the floor.
2. Place the line laser 3 to 5 m away from the wall.
3. Adjust the attitude so that the bubble in the level comes to the center of the red circle.
4. Set the laser beam mode either the "vertical line" or "2-vertical line".
5. Rotate the line laser observing the plumbing point on the ceiling.  
The result is normal if the plumbing point moves only within the width of the laser line.
6. Rotate the line laser horizontally and align the vertical laser line with the "plumb" string.  
Alignment can be adjusted using the rotation fine adjustment knob.  
The result is normal if the vertical laser line and "plumb" string are aligned.



### 3. Checking the 180°vertical line

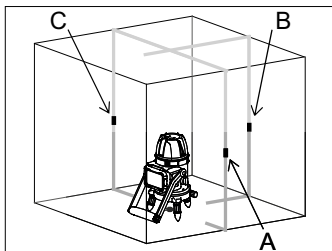

1. Make a mark on the floor near the center of a room with 4 to 6 m walls.
2. Emit the vertical line beam.
3. Mark A near the center of the vertical laser line on the right wall, and mark B near the center of the "90°vertical laser line" on the front wall.  
Mark C near the center of the "180°vertical laser line" on the left wall.

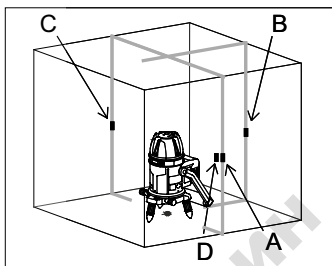

4. Turn the line laser by 180°keeping it in its original position, align the "right side vertical line" with point C on the left wall, and mark D near the center of the "left side vertical line" on the right wall.
5. The result is normal if the difference between points A and D is within 1 mm.



#### 4. Checking the 90°vertical line

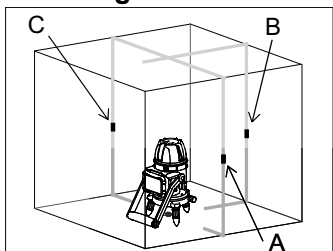

1. Make a mark on the floor near the center of a room with 4 to 6 m walls.
2. Emit all vertical line beams.
3. Mark A near the center of the vertical line on the right wall, and mark B near the center of the "90°vertical line" on the front wall. Mark C near the center of the "180°vertical line" on the left wall.

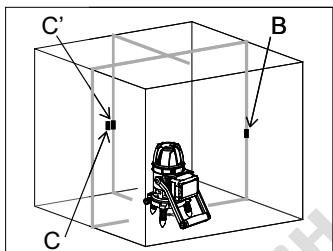

4. Turn the line laser by 90°keeping it in its original position, align the "right side vertical line" with "B on the front," and mark C' near the center of the "90°vertical line" on the left wall.
5. The result is normal if the difference between C and C' is within 1 mm.



[SK209GD]

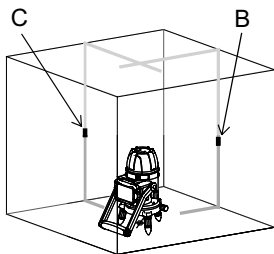

1. Make a mark on the floor near the center of a room with 4 to 6 m walls.
2. Emit all vertical line beams.
3. Mark B and C near the center of the vertical line on the front and left wall.

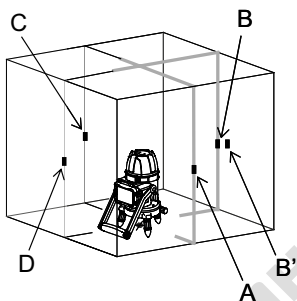

4. Align the vertical line on the front with C, and mark D near the center of the rear wall.
5. Likewise, mark A and B'.
6. The result is normal if the difference between B and B' is within 3 mm.



## MAINTENANCE

### CAUTION

Always be sure that the tool is switched off and the battery cartridge is removed before attempting to perform inspection or maintenance.

To maintain product SAFETY and RELIABILITY, repairs, any maintenance or adjustment should be performed by Makita Authorized or Factory Service Centers, always using Makita replacement parts.



МАГАЗИН  
БАШ МАЙСТОРА  
ПРОФЕСІОНАЛНИ РЕШЕННЯ



МАГАЗИН  
БАШ МАЙСТОРА®  
ПРОФЕСИОНАЛНИ РЕШЕНИЯ

Makita Europe N.V. Jan-Baptist Vinkstraat 2,  
3070 Kortenberg, Belgium

Makita Corporation 3-11-8, Sumiyoshi-cho,  
Anjo, Aichi 446-8502 Japan

[www.makita.com](http://www.makita.com)