

ROTHENBERGER

ROPOWER 50 R

ROPOWER 50 R



DE Bedienungsanleitung
EN Instructions for use
FR Instruction d'utilisation
ES Instrucciones de uso
IT Istruzioni d'uso
NL Gebruiksaanwijzing
PT Instruções de serviço
DA Brugsanvisning
SV Bruksanvisning
NO Bruksanvisning

FI Käyttöohje
PL Instrukcja obsługi
CZ Návod k používání
TR Kullanım kılavuzu
HU Kezelési útmutató
ET Kasutusjuhend läbi
LT Naudojimo instrukcija
LV Lietošanas pamācība
EL Οδηγίες χρήσεως
RU Инструкция по использованию



www.rothenberger.com

A Overview

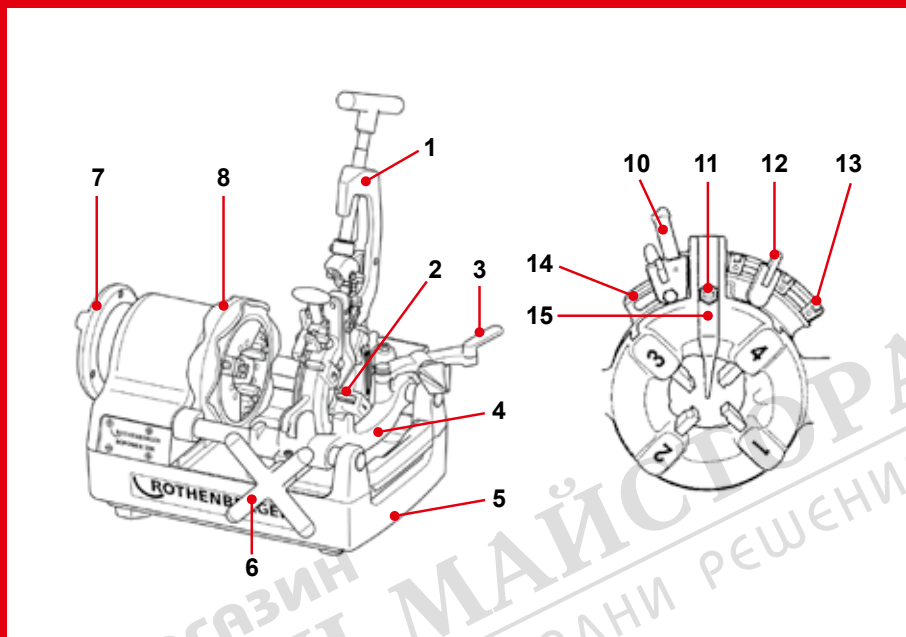

B Clamping



C Cutting

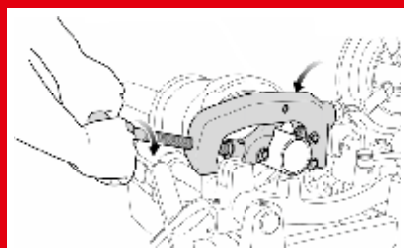

D Reaming



Remove and installing thread jaws E

1

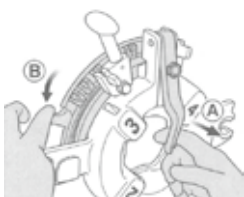

2



3

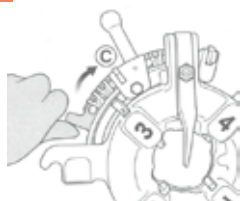

Changing thread size F



Threading G

1

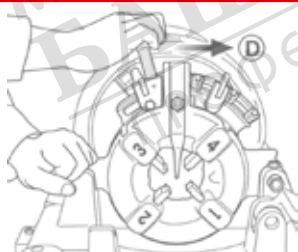

2



Changing clamping jaws H

1

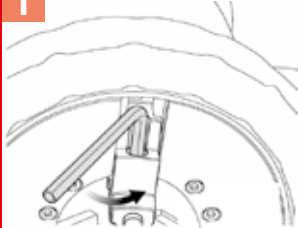

2

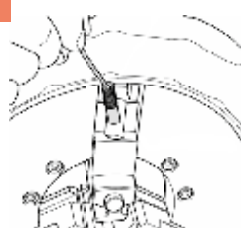

3

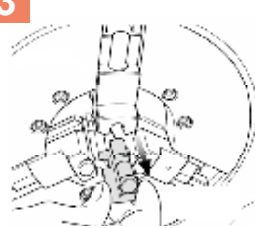

1	Safety Notes	17
1.1	Intended use.....	17
1.2	General safety instructions	17
1.3	Special safety instructions	18
2	Technical Data	19
3	Function of the Unit	20
3.1	Overview (A).....	20
3.2	Functional description.....	20
4	Preparations for operation	20
4.1	Transporting the threading machine	21
4.2	Setting up the machine.....	21
4.3	Electrical connection.....	21
4.4	The thread cutting oil	21
4.5	Checking the thread cutting oil.....	22
4.6	Setting the supplied thread cutting oil quantity	22
4.7	Draining off the oil.....	22
5	Operation of the threading machine	23
5.1	Clamping the workpieces (B)	23
5.2	Cutting the workpiece with the pipe cutter (C).....	23
5.3	Reaming the workpieces (D).....	23
5.4	Removing and installing the dies (E).....	24
5.5	Installing and removing the thread-tapping head into and out of the bed carriage	24
5.6	Changing the thread size (F)	24
5.7	Tapping threads (G)	24
5.8	Setting the thread length.....	25
5.9	Setting the thread depth	25
5.10	Removing the workpiece	25
5.11	Cleaning after use	26
6	Maintenance and inspection	26
6.1	Changing the internal deburrer blade.....	26
6.2	Changing the pipe cutter cutting wheel	26
6.3	Changing the clamping jaw inserts (H).....	27
6.4	Daily inspection	27
6.5	Lubrication of spindle support	27
7	Accessories	28
8	Customer service	28
9	Disposal	28
9.1	Metal, electrical and electronic parts	28
9.2	Oils and lubricants	28

Markings in this document:



Danger!

This sign warns against the danger of personal injuries.



Caution!

This sign warns against the danger of property damage and damage to the environment.



Call for action

1 Safety Notes

1.1 Intended use

The threading machine ROPOWER 50 R may only be used for cutting off, making and deburring BSPT, NPT threads measuring 1/4" – 2" as described in Chapter 2 "Technical data".

The ROPOWER 50 R threading machine may only be operated with suitable die heads that have been inspected and recommended by ROTHENBERGER Werkzeuge GmbH, and with dies as described in Chapter 2 "Technical data".

The supplied safety pedal carries the GS approval of the professional liability insurers' association and is compulsory for using the machine in the Federal Republic of Germany.

Never make technical or design modifications to the thread-tapping machine and to the accessory parts.

→ This would render the operating permit void and would represent an accident and injury risk.

When using electrical tools and machines, basic safety measures must be observed and followed in order to provide protection against electric shock, injury and fire risks. Read the instructions precisely before using the machine.

Always keep the safety instructions to hand.

1.2 General safety instructions



ATTENTION! When using electric tools, the following fundamental safety measures must be taken to prevent electric shock, injury or fire.

Read all of these instructions before you use the electric tool, and store the safety instructions properly.

Service and maintenance:

- 1 **Regular cleaning, maintenance and lubrication.** Always pull the electrical plug before any adjustment, maintenance or repair.
- 2 **Have your device repaired only by qualified experts and only with original replacement parts.** This ensures the continued safety of the device.

Working safely:

- 1 **Keep your work area orderly.** A messy work area can cause accidents.
- 2 **Consider environmental influences.** Do not expose electric tools to rain. Do not use electric tools in damp or wet environments. Keep the work area well lit. Do not use electric tools where there is a risk of fire or explosion.
- 3 **Protect yourself from electric shock.** Avoid physical contact with earthed parts (such as pipes, radiators, electric stoves or cooling devices).
- 4 **Keep other people away.** Do not let other people — especially children — touch the electric tool or its cable. Keep them away from the work area.
- 5 **Store electric tools safely when they are not in use.** Unused electric tools should be kept in a dry, high or closed area, out of reach of children.
- 6 **Do not overload your electric tool.** Work is better and safer within the performance range indicated.

- 
- 7 **Use the right electric tool.** Don't use low-performance machines for heavy-duty jobs. Do not use the electric tool for purposes for which it was not intended. For example, do not use a portable circular saw for cutting tree branches or logs.
 - 8 **Wear proper clothing.** Do not wear loose clothing or jewellery, as they can get caught in moving parts. When working outdoors, wear slip-resistant shoes. Wear a hairnet over long hair.
 - 9 **Use protective gear.** Wear safety glasses. Wear a breathing mask during work that creates dust.
 - 10 **Connect the dust extraction equipment.** If there are connections to dust extraction and collection equipment, make sure that they are connected and properly used.
 - 11 **Do not use the cable for purposes for which it was not intended.** Never use the cable to pull the plug from the socket. Protect the cable from heat, oil and sharp edges.
 - 12 **Secure the work piece.** Use clamps or a vice to hold the work piece firmly. They will hold it more securely than your hand can.
 - 13 **Avoid abnormal postures.** Make sure to stand securely and always keep your balance.
 - 14 **Maintain your tools with care.** For better and safer work, keep cutting tools sharp and clean. Follow the instructions for lubrication and changing tools. Regularly inspect the electric tool's connection cable, and if it is damaged, have it replaced by an authorized expert. Regularly check extension cords and replace them if they are damaged. Keep the handles dry, clean and free of oil and grease.
 - 15 **Pull the plug from the socket.** When not using the electric tool, before maintenance or when changing tools, such as saw blades, drills and cutting bits.
 - 16 **Do not leave any tool keys inserted.** Before switching on, check to see that keys and adjustment tools have been removed.
 - 17 **Avoid unintentional activation.** When plugging the tool in, make sure that the switch is turned off.
 - 18 **Use outdoor extension cords.** When outdoors, use only extension cords that are approved and appropriately marked.
 - 19 **Be alert.** Pay attention to what you do. Approach your work sensibly. Do not use the electric tool when you are distracted.
 - 20 **Check the electric tool for damage.** Before using the electric tool, you must inspect safety equipment or slightly damaged parts carefully to ensure that they work properly and as intended. Check to see that the moving parts operate freely and don't stick, and to make sure no parts are damaged. All parts must be mounted properly and meet all the conditions for ensuring trouble-free operation of the electric tool.
Damaged safety equipment and parts must be properly repaired or replaced by a professional facility, unless otherwise indicated in the user manual. Damaged switches must be replaced by a customer service facility.
Never use an electric tool whose switch cannot be turned on and off.
 - 21 **Caution.** Using other insertion tools and accessories may cause injury.
 - 22 **Have your tool repaired by an electrical expert.** This electric tool meets applicable safety requirements. Repairs must be made only by an electrical expert using original replacement parts. Otherwise accidents may occur.

1.3 Special safety instructions

Never put fingers, your face, hair or other parts of the body, or loose, wide items of clothing into the operating and intake areas of rotating parts (workpiece, clamping chuck, centring chuck). Do not wear jewellery (rings, chains etc.). Risk of injury and accidents!

In the event of faults (unusual smell, vibrations, unusual noises) during work with the ROPO-WER 50R, it is essential to immediately press the safety pedal and perform an EMERGENCY STOP of the machine!

If the machine is running, it is prohibited to hold the workpieces manually or to perform similar work, and to fit and remove parts such as filters, valves, pipe sections etc!

Wear safety clothing! Wear a safety mask to provide protection against splashes of thread cutting oil as well as any chlorine gas vapours (from thread cutting oil burning on hot tool and workpiece surfaces)! Wear a safety hat to cover and protect long hair. Wear safety gloves when changing the dies, the pipe cutting wheel and the pipe deburrer. Wear safety gloves when changing the tool and workpiece. The thread and dies get hot during thread cutting! Wear safety footwear. Risk of injury (slipping) on any escaping thread cutting oil! Risk of injury from wet, slippery and possibly off-centre machine parts when changing the tool!

Do not remove metal chips using compressed air! There is a risk of eye injuries and loss of eyesight!

Ensure sufficient ventilation during indoor use (closed rooms). The permissible ambient temperature is between 0°C and 40°C!

Before changing the die head, the cutting wheel, the pipe deburrer, always switch off the machine and pull out the mains plug (de-energized operation)!

After it has been switched off, the machine still coasts for a while until it comes to a standstill.

Do not touch any parts before the machine is completely stationary and the mains plug has been pulled out!

In the case of the threaded pipes, carry out a pressure test in order to ensure that no gas or water can escape after the pipes are fitted!

Power tool plugs must match the outlet. Never modify the plug in any way. Do not use any adapter plugs with earthed (grounded) power tools. Unmodified plugs and matching outlets will reduce risk of electric shock

Use the power tool, accessories and tool bits etc., in accordance with these instructions, taking into account the working conditions and the work to be performed. Use of the power tool for operations different from those intended could result in a hazardous situation.

Follow instructions on proper use of this machine. Do not use for other purposes such as drilling holes or turning winches.

Secure machine to bench or stand. Support long heavy pipe with pipe supports.

While operating the machine, stand on the side where the REVERSE/OFF/FORWARD or FORWARD/REVERSE switch is located.

Keep covers in place. Do not operate the machine with covers removed.

Do not use this machine if the footswitch is broken or missing

Setting-up or fixing power tool in a stable position as appropriate for power tools which can be mounted on a support or fixed to the floor.

Connection to power supply, cabling, fusing, socket type and earthing requirements.

Tools adjustable to different rated voltages shall include instructions, illustrations, or both for changing the voltage. The terminal identification shall be provided if the motor connection has to be altered to operate at a voltage other than that for which it was connected when shipped from the factory.

Keep handles and grasping surfaces dry, clean and free from oil and grease. Slippery handles and grasping surfaces do not allow for safe handling and control of the tool in unexpected situations.

2 Technical Data

Art.-no. 56050ROPOWER 50 R, 230 V, BSPT R 1/2" – 2"

Art.-no. 56045ROPOWER 50 R, 110 V, BSPT R 1/2" – 2"

Art.-no. 56057ROPOWER 50 R, 230 V, BSPP R 1/2" – 2"

Speed under no load40 min⁻¹ (rpm)

Single-phase universal motor1150 W, overload protection

Frequency50 / 60 Hz

Weight (without accessories)ca. 68 kg

Dimensions (LxWxH)535 x 430 x 340 mm

Die head Automatic-die head 1/2" – 2" or 2 SE die heads
 Dies 1/2" – 3/4", 1" – 2" (Optional 1/4" – 3/8" Art.-No. 56369)

Noise pressure level (L_{pA}) 85 dB (A) | K_{pA} 3 dB (A)

Sound power level (L_{WA}) 96 dB (A) | K_{WA} 3 dB (A)

The noise level during operation can exceed 85 dB (A). Wear hearing protection!

Measured values determined in accordance with EN 61029-1:2010.

Vibration total value < 2,5 m/s² | $K = 1,5\text{m/s}^2$

The vibration level given in this information sheet has been measured in accordance with a standardised test given in EN 61029 and may be used to compare one tool with another. It may be used for a preliminary assessment of exposure.



The declared vibration emission level represents the main applications of the tool. However if the tool is used for different applications, with different accessories or insertion tools or is poorly maintained, the vibration emission may differ. This may significantly increase the exposure level over the total working period.

An estimation of the level of exposure to vibration should also take into account the times when the tool is switched off or when it is running but not actually doing the job. This may significantly reduce the exposure level over the total working period.

Identify additional safety measures to protect the operator from the effects of vibration such as: maintain the tool and the accessories, keep the hands warm, organisation of work patterns.

3 Function of the Unit

3.1 Overview

(A)

1	Pipe cutter	8	Clamping chuck
2	Dies	10	T-handle
3	Internal deburrer	11	Locking lever
4	Tool carriage	12	Selector pin
5	Oil drainage screw	13	Selector block
6	Feeder hand wheel	14	Cam plate
7	Centring chuck	15	Locking lever

3.2 Functional description

Threads are cut or turned on workpieces such as pipes or rods in the thread-tapping machine ROPOWER 50 R.

The machine consists of:

- a drive motor that rotates the centring chuck
- a clamping chuck for securing the workpiece
- a pipe cutter for cutting the workpiece to length
- an internal deburrer
- a thread-tapping head for making a thread on the workpiece
- an oil pump that lubricates and cools with thread-tapping oil
- a tool carriage guided on both sides with a toothed feed
- a chip collecting and oil trough
- a safety pedal
- a coasting restrictor

4 Preparations for operation

4.1 Transporting the threading machine



Bend at the knees when lifting the machine so as to protect your back against over-stressing.

Weighing more than 35 kg, you need 2 people to carry the machine safe!



Fix the tool carriage so that it cannot move while the machine is being transported. Hold the machine securely by its base to lift it. Do not hold the machine by its centring chuck or the internal deburrer when carrying it!



If the machine is transported with the thread-tapping oil still inside, the oil might splash out onto clothing due to vibrations!



Thread-tapping oil on the surface of the machine makes it slippery. Ensure that it does not slip out of your hands when you lift it!

4.2 Setting up the machine



Set up the machine in a dry location!

Place the machine on a level surface without spaces or on a flatwork bench. The centring chuck must be higher in relation to other parts of the machine so that no thread-tapping oil can escape via the pipe being machined and contaminate the floor!

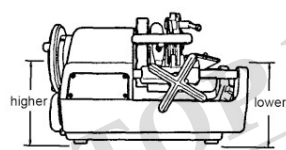

If you do not have a clear view of the dangerous area formed by the machine and the revolving workpiece, the full length of the revolving workpieces must be reduced or the dangerous area must be safeguarded by a cordon or warning signs! The safety fixtures must be set up and secured firmly. If supports are used for this purpose, they must be height-adjustable and sturdy and there must be a sufficient number of them!

4.3 Electrical connection



Do not place either the machine or workpieces on the connecting cable, otherwise the cable could be damaged and electrical current could be exposed, presenting an electric shock hazard!



Never touch the mains plug and mains cable with wet hands. Electric shock hazard!



When connecting the machine to the electricity supply, always ensure that the switch is set to "OFF", otherwise there is a risk that the machine will start up unnoticed and unsupervised when the power is connected!



It is essential that the voltage on the machine's rating plate corresponds to the power source, otherwise the machine could get hot, smoke could develop, start a fire and cause damage!



The integrated overload protection automatically stops the machine in the event of an overload or power fluctuations! Switching back on is not possible until one minute has elapsed!



Use the extension cable H07 RN 3 x 1.5 mm²! The cable should not be longer than 30m!

4.4 The thread cutting oil



For tapping, use ROTHENBERGER high-performance thread-tapping oil art. no. 65010. **This oil is not suitable for tapping drinking water pipes!**

Alternatively, you can use ROTHENBERGER high-performance thread-tapping fluid, art. no. 65015. This fluid is **suitable** for tapping all pipelines **including drinking water pipelines**.



Keep thread-tapping oils out of the reach of children!



Do not thin thread-tapping oil or mix it with other oils! If the thread-tapping oil becomes mixed with water, it turns milky-white, its quality is reduced and the tapped thread displays lower quality. It is then recommended to change the oil!

Avoid direct sunlight and store the oil in a dark place!

Close the oil container tight after use in order to prevent the ingress of dirt and water!



ATTENTION PERSONS WITH ALLERGIES!

Thread-tapping oil that lands on the skin can cause skin irritation, inflammation and allergic reactions! When handling oil, wear protective clothing and cover exposed skin areas. If your skin comes into contact with oil, wash it immediately with tap water and soap. If thread-tapping oil burns onto hot workpiece or tool surfaces, this can produce toxic vapours or gases (e.g. chlorine gas when red oil burns). If you have accidentally inhaled this oil mist or oil vapours, go out into the fresh air immediately and consult a doctor without delay!

4.5 Checking the thread cutting oil



When cleaning, servicing, inspecting or repairing the machine, it is essential to switch it off and pull out the mains plug (de-energised operation)!

- ➔ Turn the rotary handle (6) clockwise in order to move the tool carriage (4) to the clamping chuck (8).
- ➔ On the right side of the machine, fill up with the thread tapping oil to the level of the sieve mesh.
- ➔ Ensure that the machine is still switched off and insert the mains plug back into the socket.
- ➔ Switch on the machine and ensure that the thread-tapping oil runs out of the thread-tapping head to the cutting jaws. If the right amount of oil is not supplied, regulate it with the oil adjustment screw.

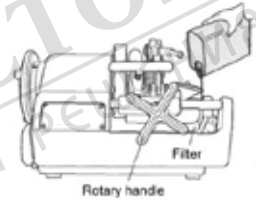

4.6 Setting the supplied thread cutting oil quantity



When cleaning, servicing, inspecting or repairing the machine, it is essential to switch it off and pull out the mains plug (de-energised operation)!

- ➔ Ensure that the oil tank is filled with oil up to the level of the sieve mesh.
- ➔ If the amount of thread-tapping oil running via the thread tapping head does not meet the requirements, the supplied amount must be adjusted with the aid of the oil adjustment screw.
- ➔ Undo the locking nut of the oil adjustment screw.
- ➔ Turning the oil adjustment screw clockwise increases the amount of oil delivered and turning it anti-clockwise reduces the amount.
- ➔ Tighten the locking nut firmly after making the adjustment.



4.7 Draining off the oil



It is essential to also observe the safety and disposal regulations in Chapter 9!

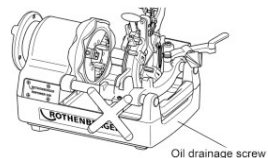

5 Operation of the threading machine

5.1 Clamping the workpieces

(B)

- ! **The tool carriage can make contact with the frame before the thread cutting process has ended and the clamping chuck and the machine can be damaged as a result! A clearance of at least 70 mm must therefore be maintained between the thread cut on the workpiece and the clamping chuck!**

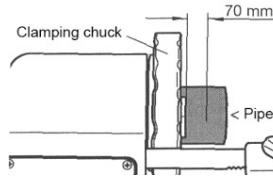

- Move the pipe cutter and the die head up so that they are not in the way and position the internal deburrer on the rear side.
- Insert the workpiece from the centring chuck side (fig. 1) and tighten the centring chuck (fig. 2).
- Hold the workpiece on the clamping chuck side securely with your right hand and gradually tighten it with the clamping chuck (fig. 3).
- Ensure that the three clamping jaws are in contact with the workpiece.

- ! **If the three clamping jaws are not in contact with the workpiece, it will wobble and neither cutting nor thread cutting can be performed correctly.**

- Clamp the workpiece securely and tighten it very firmly.

- ! **In the case of long or heavy pipes, it is essential to use the pipe support Art. No. 56047 in order to prevent the workpiece wobbling or twisting while it is being turned and to prevent the machine from tipping over due to the weight of the workpiece! Otherwise, the workpiece and the machine can become unstable!**

5.2 Cutting the workpiece with the pipe cutter

(C)

- ! **Do not touch the cutting surface with bare hands, because it is hot and has sharp edges! Risk of injury and burning!**

- ! **If the handle of the pipe cutter is turned with force, the cutting surface of the pipe takes an oval shape, which makes correct thread cutting impossible. Therefore, move the handle of the pipe cutter half a turn per whole pipe rotation!**
- Move the pipe cutter up so that it is not in the way. Turn the feeder hand wheel clockwise in order to bring the pipe cutter into the position necessary for cutting the workpiece.
- Move the pipe cutter down onto the workpiece and then press the ON switch or press the pedal.
- Turn the handle of the pipe cutter powerfully clockwise and start to cut the workpiece.
- Swivel the pipe cutter down and back again.

- ! **Do not collect the cut pipes in the trough! Take them out of the trough immediately after the cutting process ends!**

5.3 Reaming the workpieces

(D)

- ! **The cutting tip of the internal deburrer is very sharp! Do not touch it with bare hands! Risk of cutting and injury!**

- Pull the internal deburrer towards you.
- Turn the feeder hand wheel clockwise and gently press the cutting edge of the reamer against the inside of the pipe in order to ream.

- Turn the rotary handle further and gently press the cutting edge of the reamer against the inside of the pipe in order to ream.

5.4 Removing and installing the dies (E)



Wear gloves in order to prevent cut injuries to the hands caused by the dies!

Removal:

- Pull the parking lever into the "A" position.
- Open the selector pin (silver colour) at the selector block.
- Lift out the thread-tapping head and pull the thread jaws no. 1 to 4 down.

Installation:

- Pull the parking lever in the "A" direction.
- Open the selector pin (silver colour) at the selector block.
- Insert the thread jaws with the same number as on the respective thread-tapping head and make sure it engages audibly.
- Slide cam plate toward C until a click sound is heard from locking lever.
- Ensure that the numbers on the thread-tapping head and on the thread jaws are on the same side.



Precise thread-tapping is only possible if the number on the slot of the thread-tapping head corresponds with the number on the thread jaw!



After changing the thread-tapping jaws, check that they are secure! After changing the thread-tapping head or replacing the thread-tapping jaws, check that they are locked securely in the tool carriage!

5.5 Installing and removing the thread-tapping head into and out of the bed carriage

- Lift the thread-tapping head to half height.
- Bring the thread-tapping head into the diagonal position and remove it.
- Not until the thread-tapping head is in a parallel position to the flat side of the thread-tapping pin can it be removed from or installed in the machine.

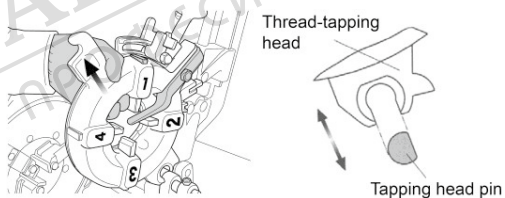

5.6 Changing the thread size (F)

- Ensure that the thread-tapping head is on the tool carriage and that the thread jaws correspond to the thread size.
- Insert the selector pin into the selector block with the necessary thread size.
- The size is shown on the respective selector block.

5.7 Tapping threads (G)

- If there is a dangerous situation, press the safety pedal right down. This stops the machine.
- To restart the machine, press the blue release button on the side of the safety pedal.

To guarantee precisely ground threads, follow the instructions below:



Use only raw material that is in perfect condition for tapping threads. If you use deformed and / or pipes cut off at an angle, it is not possible to tap threads that conform to the relevant standards!

Use the thread-tapping head and the corresponding thread-tapping jaws that match the thread size!

Secure the thread-tapping head correctly on the tool carriage.

Do not place the thread-tapping head directly and unprotected on the floor and handle it with care!

Ensure that the thread-tapping oil runs on the thread-tapping jaws!

- ➔ Lower the thread-tapping head and insert the T handle, pressing in fully in the "B" direction until the thread-tapping jaws engage in the working position.
- ➔ Switch on the machine with the pedal; turn the rotary handle clockwise so that the thread jaws press onto the workpiece.
- ➔ Release the rotary handle when 2 to 3 thread turns are cut.
- ➔ The thread-tapping jaws open automatically via a longitudinal stop lever when the thread has been fully cut.
- ➔ Switch off the machine by taking your foot off the safety pedal.

5.8 Setting the thread length

The thread length was set by the manufacturer but can be changed if required.

- ➔ Hold set pin with a slot screwdriver and loosen hex nut.

- ➔ Turning set pin toward "E", makes shorter threads and turning toward "F" makes longer threads. The thread length will be changed about 2mm by half turn.
- ➔ Hold set pin with a slot screwdriver not to turn it and tighten hex nut.

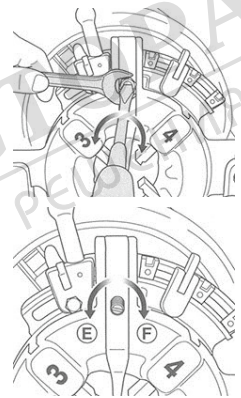

5.9 Setting the thread depth

- ➔ Set location plate to location block which is not for the size to be adjusted.
- ➔ Loosen the screw and move location block to adjust the thread depth.
- ➔ Sliding toward "G" makes deeper threads and sliding toward "H" makes shallower threads. The thread depth will change 1.5 to 2 mm threads by one scale.

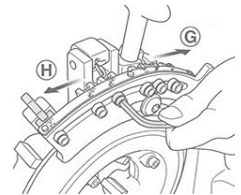

With the aid of a measuring instrument, check the cut pipe for a tapered thread etc. and correct the setting if necessary.

5.10 Removing the workpiece



The workpiece is damp and slippery from the thread-tapping oil. Carefully ensure that it does not slip out of your hands and drop onto your feet when you remove it from the machine!

- ➔ Turn the feeder hand wheel anti clockwise and move back the tool carriage.
- ➔ Release the clamping chuck.
- ➔ Release the centring chuck and pull out the workpiece.

5.11 Cleaning after use



Do not remove metal and plastic chips using compressed air! There is a risk of eye injuries and loss of eyesight! Do not pick up sharp-edged metal chips with your bare hands! Risk of injury! Wear protective gloves!

- Remove chips from on and around the machine.
- Use a wire brush to remove chips from and clean the clamping chuck, the thread-tapping jaws of the thread-tapping head and the internal deburrer.
- Use a cloth to wipe thread-tapping oil splashes from the machine and the workplace.

6 Maintenance and inspection

The plug or electrical cord should be replaced only by the manufacturer of the electric tool or by its repair service.

All machines are subject to natural wear during use. They must be maintained from time to time and wear parts must be replaced. This work may only be carried out by an authorized ROTHENBERGER service station. This gives you a full warranty on the material and workmanship!



If the machine is being cleaned, maintained, inspected or repaired, it is essential to switch it off and to pull out the mains plug (de-energized operation)! Always avoid uncontrolled starting-up of the machine. Risk of injury and accidents!

6.1 Changing the internal deburrer blade



Always wear protective gloves when replacing the blades! Risk of cuts and injury!

- Remove the spring pin out of the next of the reamer blade.
- The reamer blade is released when you pull the reamer blade holder forwards.
- Fit a new reamer blade.
- Put the previously removed spring pin back into the hole of the new reamer blade.

6.2 Changing the pipe cutter cutting wheel



Always wear protective gloves when replacing the blades! Risk of cuts and injury!

- Bring the pipe cutter into an upright position and lower the thread-tapping head.
- Pull off the cotter pin upwards.
- Hold the cutting wheel and push the cutting wheel straight pin slowly out on the opposite side.

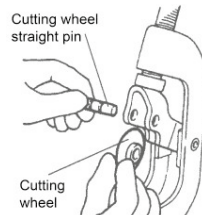
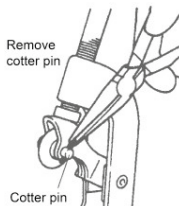

- Insert a new cutting wheel into the blade holder and insert the pin again.
- Insert a new cotter pin into the cutting wheel straight pin and secure it by bending it apart.

6.3 Changing the clamping jaw inserts

(H)

- Turn the clamping chuck and open it until a screwdriver fits inside.
- Undo the screws that secure the clamping jaw inserts (fig. 1).
- Place a thin rod onto the upper edge of the spring and pull out the clamping chuck pin (fig. 2).
- Pull the clamping jaw insert forward (fig. 3).
- Insert a new clamping jaw insert and push it right to the back, replace the spring and the clamping chuck pin. Tighten the screw.

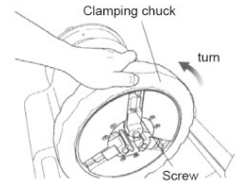

6.4 Daily inspection



Attention! Before starting the lubrication-works the power plug has to be taken out of the power source.

- Check the mains plug, mains cable and extension cable to ensure they are undamaged.
- Correctly filled oil trough.
- Clean the oil tank if there are impurities in it.
- Inspect the dies, pipe cutter and internal deburrer for any wear and replace parts if there is wear.
- Clean the clamping jaws with a wire brush if they are dirty.
- Check that the dowel screws are secure. Tighten if necessary.
- Remove dirt and chips from the machine regularly.
- Apply anti-rust grease if the machine is not going to be used for an extended period.
- The rear spindle support has to be lubricated periodically. The lubrication is only allowed for persons which have been supervised in electrical safety issues.

6.5 Lubrication of spindle support



The rear spindle support has to be lubricated periodically.

1. Unscrew the motor cover mounting bolts and remove the motor cover from the machine.
2. The grease nipple located behind of the scroll (Fig. 52).
3. Use grease gun to pour grease (Fig. 53).

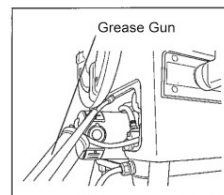
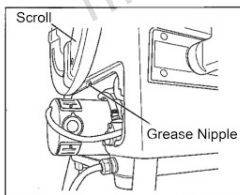

7 Accessories

Accessory Name	ROTHENBERGER Part Number
Pipe Supporting Column for pipes up to 6"	56047
Spare cutting wheel	70074
RONOL Canister	65010
RONOL Spray can	65008
RONOL SYN Canister (suitable drinking water)	65015
RONOL SYN Spray can (suitable drinking water)	65013
Thread-cutting heads	www.rothenberger.com
NIPPEL MAX 1/2 – 3/4 – 1 – 1.1/4 – 1.1/2"	56056
Hemp Dispenser with Roll, 40 g / 40 m	70623
Replacement Safety Foot Switch, 3-step, 230 V	56335
Thread-cutting die	www.rothenberger.com
Pipe Roughing Wrench 3/8 – 2"	56500

8 Customer service

The ROTHENBERGER service locations are available to help you (see listing in catalog or on-line) and replacement parts and service are also available through these same service locations. Order your accessories and spare parts from your specialist retailer or using our service-after-sales hotline:

Phone: + 49 (0) 61 95 / 800 – 8200

Fax: + 49 (0) 61 95 / 800 – 7491

Email: service@rothenberger.com

www.rothenberger.com

9 Disposal

9.1 Metal, electrical and electronic parts

Components of the unit are recyclable material and should be put to recycling. For this purpose registered and certified recycling companies are available. For an environmental friendly disposal of the non-recyclable parts (e.g. electronic waste) please contact your local waste disposal authority.

For EU countries only:



Do not dispose of electric tools with domestic waste. In accordance with European Directive 2012/19/EC on waste electrical and electronic equipment and its implementation as national law, electric tools that are no longer serviceable must be collected separately and utilised for environmentally compatible recycling.

9.2 Oils and lubricants

Only specialist companies are authorised to dispose of old oils.

Old oils and contaminated oils must be stored and disposed of in sealed, oil-resistant containers (metal drums).

Defective electrical appliances and machines that cannot be repaired must be opened and cleaned to remove the remaining oil.

Oil troughs must be cleaned so that there are no traces of oil. No oils (even very small amounts) may be allowed to enter the ground.