	<b>TECHNICAL DATA SHEET</b>	Reference	FT HE-en
		Date	17/06/2014
		Update	7 
		Page	1 of 6
Denomination: DROP-IN ANCHOR		Code	HEHO, HENOM, HECLOM, HEH4

**HEHO  
HENOM**



**HEA4**



**HECLOM**

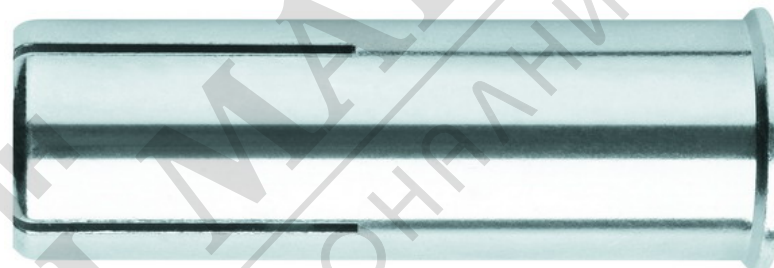



**EXHB**



## 1. CHARACTERISTICS

- Metallic anchor, with functioning principle by expansion and installation by deformation.
- Surface level installation finish, and female thread.
- Use for medium loads.
- Functioning: expansion of the anchor body by hitting the expansion cone with a specific tool and a hammer.
- For use in concrete and natural, dense stone.
- HEHO and HECLOM granted with European Technical Assessment ETA 14/0068 for structural applications in non cracked concrete and ETA 14/0135 for multiple use in no structural applications in concrete.
- Diameter range available: M6 to M20.
- Versions in zinc plated and A4 stainless-steel.
- Drop-in anchors are delivered without bolt.
- Possible to dismount at any time, and reinstall again.
- Suitable for installations that require to be dismantled permanently and also assembled again, maybe to allow the circulation of vehicles or pedestrians, or marquees and stalls, for instance.
- Applications: pipelines, trays, vents, sprinkler system, banisters, metallic profiles, bars, fastening diamond drillings, etc.

	<b>TECHNICAL DATA SHEET</b>	Reference	FT HE-en
		Date	17/06/2014
		Update	7 
		Page	2 of 6
Denomination: DROP-IN ANCHOR		Code	HEHO, HENOM, HECLOM, HEH4

## 2. MATERIALS

ITEM	BODY
HEHO, HENOM, HECLOM	Steel, zinc plated $\geq 5 \mu\text{m}$ ISO 4042 A2
HEA4	A4 Stainless steel

## 3.- DIMENSIONS

SIZE	M6	M8	M10	M12	M16	M20
Code approved zinc plated	HEHOM06	HEHOM08	HEHOM10	HEHOM12	HEHOM16	HEHOM20
Code zinc plated	HENOM06	HENOM08	HENOM10	HENOM12	HENOM16	HENOM20
Code zinc plated with flared lip	HECLOM06	HECLOM08	HECLOM10	HECLOM12 HECLOM12D*	HECLOM16	---
Code A4 stainless steel	HEA4M06	HEA4M08	HEA4M10	HEA4M12	HEA4M16	HEA4M20
$d_p$ : outer diameter [mm]	8	10	12	15 16 (HECLOM12D)	20	25
l: capsule length [mm]	25	30	40	50	65	80
Inner metric thread [mm]	M6	M8	M10	M12	M16	M20

\*For fastening diamond drilling machines.

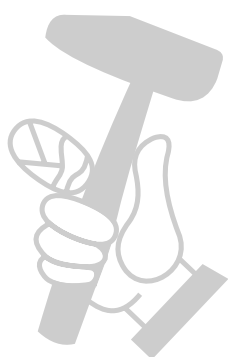

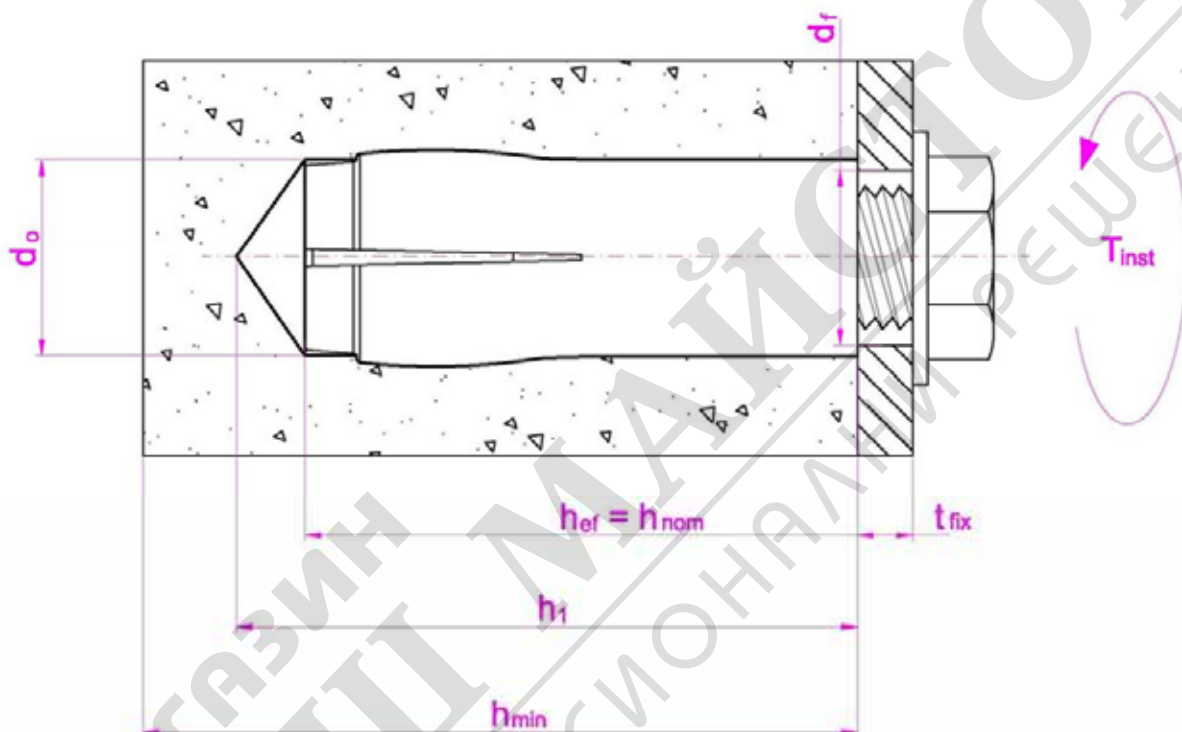

	<b>TECHNICAL DATA SHEET</b>	Reference	FT HE-en
		Date	17/06/2014
		Update	7
		Page	3 of 6
Denomination: DROP-IN ANCHOR		Code	HEHO, HENOM, HECLOM, HEH4

#### 4.- INSTALLATION DATA



SIZE	M6	M8	M10	M12	M16	M20
Code approved zinc plated	HEHOM06	HEHOM08	HEHOM10	HEHOM12	HEHOM16	HEHOM20
Code zinc plated	HENOM06	HENOM08	HENOM10	HENOM12	HENOM16	HENOM20
Code zinc plated with flared lip	HECLOM06	HECLOM08	HECLOM10	HECLOM12 HECLOM12D*	HECLOM16	---
Code A4 stainless steel	HEA4M06	HEA4M08	HEA4M10	HEA4M12	HEA4M16	HEA4M20
d <sub>0</sub> : outer diameter [mm]	8	10	12	15 16 (HECLOM12D)	20	25
h <sub>1</sub> : hole depth [mm]	27	33	43	54	70	86
h <sub>nom</sub> : installation depth [mm]	25	30	40	50	65	80
h <sub>c</sub> : base material thickness [mm]	100	100	100	100	130	160
d <sub>fix</sub> : fixture hole diameter [mm]	7	9	12	14	18	22
Inner metric thread	M6	M8	M10	M12	M16	M20
e: bolt length to be threaded (min ÷ max) [mm]	6 ÷ 10	8 ÷ 13	10 ÷ 17	12 ÷ 21	16 ÷ 27	20 ÷ 34
T <sub>ins</sub> : max.installation torque [Nm]	4	11	22	38	60	120
s <sub>cr</sub> : minimum spacing [mm]	60	90	80	100	130	160
c <sub>cr</sub> : minimum edge distance [mm]	105	105	140	175	230	280
Expansion tool code	EXHBM06	EXHBM08	EXHBM10	EXHBM12	EXHBM16	EXHBM20

\*For fastening diamond drilling machines.

	<b>TECHNICAL DATA SHEET</b>	Reference	FT HE-en
		Date	17/06/2014
		Update	7 
		Page	4 of 6
Denomination: DROP-IN ANCHOR		Code	HEHO, HENOM, HECLOM, HEH4

## 5.- INSTALLATION PROCEDURE

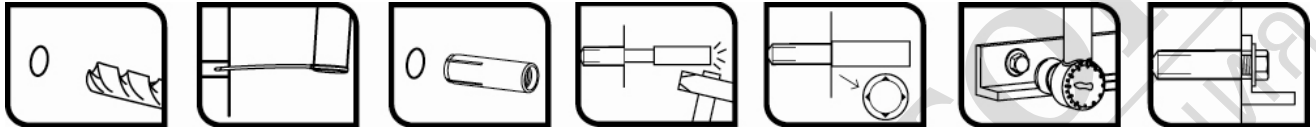

- Before installation, check the concrete's strength in order to make sure its class is not lower than required and to which the characteristic loads apply.
- The concrete base must be compact and porosity insignificant.
- Installation temperature range for base material: -5 / + 40 °C (80 °C for a short period of time).
- Minimum installation depth values must always be respected: for anchors' depth, for anchor-to-anchor distances and for anchor-to-edge distances.
- Drilling must be performed by respecting the specified minimum depth and diameter, perpendicular to the base material's surface. The holes on the material to be fixed may be used as templates. The diameter and depth of the hole must be exact.
- When drilling near any reinforcement areas, special care must be taken to avoid damaging them. If drilling is aborted because a reinforcement area has been encountered, it is advisable to drill a new hole at a minimum distance of at least twice the aborted drill hole. This advisable distance may be reduced, as long as the aborted hole is previously filled up with high-resistant mortar. In any case, if the aborted hole is not filled up with mortar, no shear or oblique tension load in the direction of load application will be tolerated at a shorter distance than the installation depth value  $h_{nom}$ .
- It is necessary to clean the holes thoroughly free of dust and debris.
- When temperature is below 0°C, make sure water does not seep into the hole, as this fact could cause subsequent cracks on the concrete, due to ice pressure.
- Introduce the anchor into the hole completely. The anchor must not stand out of the surface of the base material. Use a hammer to assure the correct full depth of the anchor if necessary.
- Insert the expansion tool into the anchor. Hammer until the setting tool is level with the anchor.
- Put the material to be fixed in place, and insert the bolt or stud through its hole. Use a wide type of washer preferably (DIN 9021).
- Do not introduce any materials or elements between the fixture and the washer (e.g. sealants). Apply the specified torque with a torque wrench.
- Torque must never exceed the values specified on datachart 4.
- The correct length of the bolt or stud to be used is shown in datachart 4, quote "e", which stands for the length to be threaded into the drop-in anchor. Longer bolts than the indicated on the datachart 4 may cause failure at any load applied.

	<b>TECHNICAL DATA SHEET</b>	Reference	FT HE-en
		Date	17/06/2014
		Update	7
		Page	5 of 6
Denomination: DROP-IN ANCHOR		Code	HEHO, HENOM, HECLOM, HEH4

- Bolt length = e + thickness to be fixed + washer thickness.
- Stud length = e + thickness to be fixed + nut thickness + washer thickness.

## 6.- CHARACTERISTIC RESISTANCES

6.1.- Characteristic resistances in non-cracked C20/25 for an isolated anchor (without spacing and edge distance effects) with bolt class 6.8 or AISI A4-70 are as per this table:



SIZE			M6	M8	M10	M12	M16	M20
Zinc plated		N <sub>R,K</sub> tensión [KN]	6.30	8.28	12.75	17.82	26.41	36.06
		V <sub>R,K</sub> : shear [KN]	6.30	8.28	<u>9.10</u>	17.82	<u>32.50</u>	<u>47.50</u>
Stain steel		N <sub>R,K</sub> tensión [KN]	6.30	8.28	12.75	17.82	26.41	36.06
		V <sub>R,K</sub> : shear [KN]	6.30	8.28	<u>10.50</u>	17.82	<u>32.10</u>	<u>51.00</u>

1KN ≈ 100 kg

Underline and cursive values correspond to steel failure.

Characteristic resistance for tension and shear must be considered separately.

### 6.2.- Recommended safety factors

SAFETY COEFFICIENTS			REDUCTION COEFFICIENT FOR RESISTANCES		INCREASING COEFFICIENT FOR LOADS
			CONCRETE FAILURE	STEEL FAILURE	
Zinc plated		Tension	1.8 <sup>1)</sup> / 2.1	--	1.4
		Shear	1.5	<u>1.25</u>	
Stain steel		Tension	1.8 <sup>1)</sup> / 2.1	--	
		Shear	1.5	<u>1.52</u>	

1) For M6, M8

### 6.3.- Calculation example:

Fixing a load tension of 1.500 kg

1.500 kg ≈ 15 KN

Increasing coefficient for loads:

1.4

Using two HENO M16 anchors

Pull load characteristic resistance for HENO M16 anchor:



26.4 KN

Concrete failure

Concrete reduction for resistances coefficient:

1.5

Checking: increased load must be lower than reduced resistance

	<b>TECHNICAL DATA SHEET</b>	Reference	FT HE-en
		Date	17/06/2014 
		Update	7
		Page	6 of 6
Denomination: DROP-IN ANCHOR		Code	HEHO, HENOM, HECLOM, HEH4

15 KN x 1.4 ≤ 2 x 26.4 KN / 1.5

Spacing must be longer than 130 mm and distance to any edge must be longer than 230 mm as well.

## 7.- APPLICATION EXAMPLES

