

D	Originalbetriebsanleitung Akku-Astscherer	RO	Instrucțiuni de utilizare originale Foarfecă de tăiat crengi cu acumulator
GB	Original operating instructions Cordless branch shears	GR	Πρωτότυπες Οδηγίες χρήσης Ψαλίδι κλαδέματος, με μπαταρία
F	Instructions d'origine Cisaille pour branches sans fil	P	Manual de instrucções original Tesoura de ramos sem fiação
I	Istruzioni per l'uso originali Troncarami a batteria	HR/ BIH	Originalne upute za uporabu Akumulatorske škare za rezanje grana
DK/ N	Original betjeningsvejledning Akku grensaks	RS	Originalna uputstva za upotrebu Akumulatorske makaze za sečenje grana
S	Original-bruksanvisning Batteridrivnen grensax	PL	Instrukcja oryginalną Sekator akumulatorowy
CZ	Originální návod k obsluze Akumulátorové nůžky na větve	TR	Orijinal Kullanma Talimatı Akülü dal budama makası
SK	Originálny návod na obsluhu Akumulátorové nožnice na konáre	RUS	Оригинальное руководство по эксплуатации Аккумуляторный сучкорез
NL	Originele handleiding Accu takkenschaar	EE	Originaalkasutusjuhend Akuoksakäärid
E	Manual de instrucciones original Tijera cortarramas inalámbrica	LV	Originālā lietošanas instrukcija Akumulatora zaru šķēres
FIN	Alkuperäiskäyttöohje Akku-oksasakset	LT	Originali naudojimo instrukcija Akumuliatorinės šakų kirpimo žirkklės
SLO	Originalna navodila za uporabo Akumulatorske škarje za veje	UKR	Оригінальна інструкція з експлуатації Аккумуляторний садовий сенатор
H	Eredeti használati utasítás Akkus-ágvágó olló		



1



2



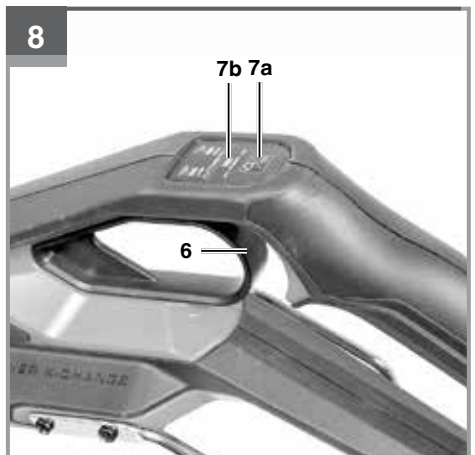
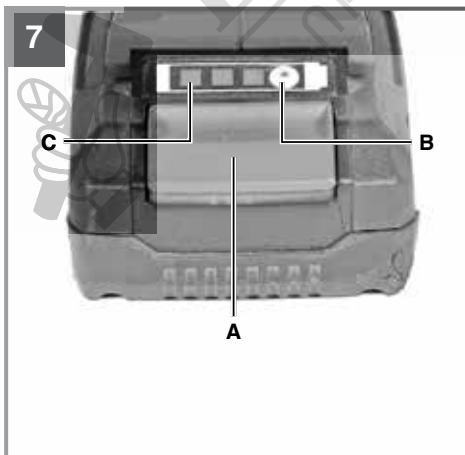
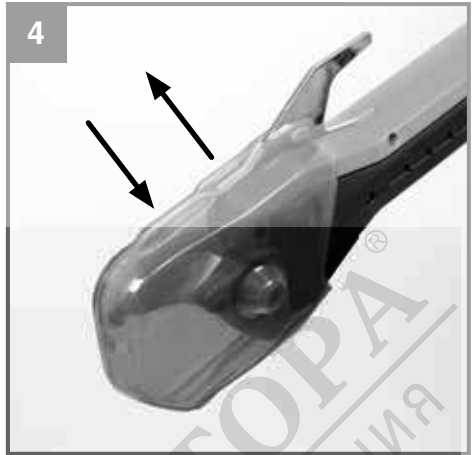
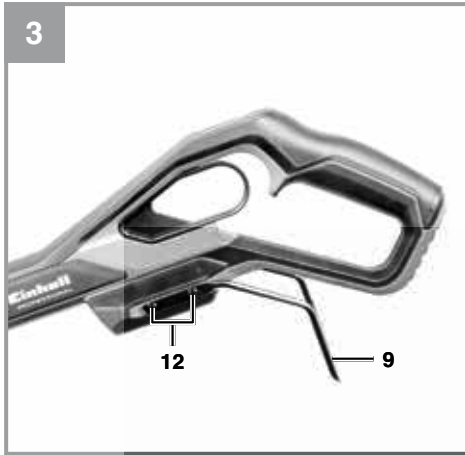

9

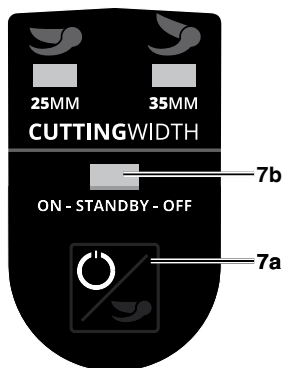

10

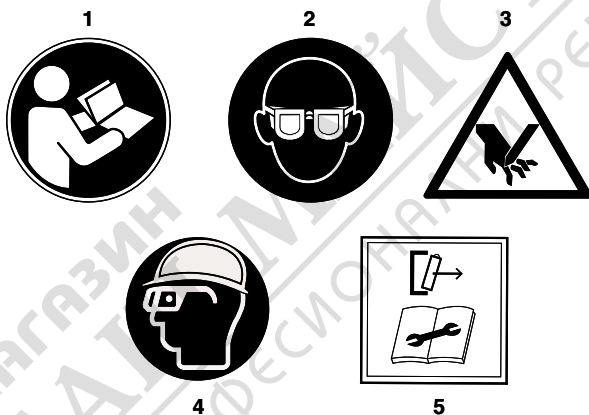

Danger!

When using the equipment, a few safety precautions must be observed to avoid injuries and damage. Please read the complete operating instructions and safety regulations with due care. Keep this manual in a safe place, so that the information is available at all times. If you give the equipment to any other person, hand over these operating instructions and safety regulations as well. We cannot accept any liability for damage or accidents which arise due to a failure to follow these instructions and the safety instructions.

Explanation of the symbols used (see Fig. 10)

1. **Danger!** - Read the operating instructions to reduce the risk of injury.
2. **Caution!** Wear safety goggles. Sparks, splinters, chips and dust emitted by the machine can cause loss of sight.
3. **Danger!** Moving blade. No hands or feet are allowed to be placed between the blades.
4. **Caution!** Wear safety goggles and head protection.
5. **Warning!** Remove the battery before working on the tool!

1. Safety regulations

The corresponding safety information can be found in the enclosed booklet.

Warning!

Read all the safety information, instructions, illustrations and technical data provided on or with this power tool. Failure to adhere to the following instructions may result in electric shock, fire and/or serious injury.

Keep all the safety information and instructions in a safe place for future use.

This equipment is not allowed to be used by children. Children should be supervised so that they do not play with the equipment. Children are not allowed to carry out the cleaning or maintenance. This equipment is not allowed to be used by people with limited physical, sensory or men-

tal capacities or by those with insufficient knowledge or experience unless they are supervised or instructed by a person who is responsible for them.

2. Layout and items supplied**2.1 Layout (Fig. 1/2)**

1. Cutting blade (movable)
2. Counter blade (stationary)
3. Hook
4. Motor head
5. Grip surface
6. Trigger
7. LED indicator and function switch
8. Handle
9. Guard handle
10. Battery mount
11. Blade guard hood
12. Assembly screws

2.2 Items supplied

Please check that the article is complete as specified in the scope of delivery. If parts are missing, please contact our service center or the sales outlet where you made your purchase at the latest within 5 working days after purchasing the product and upon presentation of a valid bill of purchase. Also, refer to the warranty table in the service information at the end of the operating instructions.

- Open the packaging and take out the equipment with care.
- Remove the packaging material and any packaging and/or transportation braces (if available).
- Check to see if all items are supplied.
- Inspect the equipment and accessories for transport damage.
- If possible, please keep the packaging until the end of the guarantee period.

Danger!

The equipment and packaging material are not toys. Do not let children play with plastic bags, foils or small parts. There is a danger of swallowing or suffocating!

- Cordless branch shears with blade guard hood

- Guard handle, screws
- Original operating instructions
- Safety instructions

3. Proper use

This tool is designed for cutting branches and plants with a diameter of max. 35 mm.

This tool is not suitable for cutting metal.

The equipment is to be used only for its prescribed purpose. Any other use is deemed to be a case of misuse. The user / operator and not the manufacturer will be liable for any damage or injuries of any kind caused as a result of this.

4. Technical data

Motor power supply: 18 V DC
 Cutting capacity max. Ø: 35 mm
 Weight: 1.55 kg

Caution!

The equipment is supplied without batteries and without a charger and is allowed to be used only with the lithium-ion batteries of the Power X-Change series!

The lithium-ion batteries of the Power X-Change series are allowed to be charged only with the Power X charger.

Danger!

Sound and vibration

Sound and vibration values were measured in accordance with EN 62841.

L_{pA} sound pressure level 72.8 dB(A)
 K_{pA} uncertainty 3 dB
 L_{WA} sound power level 74.35 dB(A)
 K_{WA} uncertainty 3 dB

Wear ear-muffs.

The impact of noise can cause damage to hearing.

Total vibration values (vector sum of three directions) determined in accordance with EN 62841.

Vibration emission value $a_h \leq 2.5 \text{ m/s}^2$
 K uncertainty = 1.5 m/s^2

The stated vibration emission levels and stated noise emission values were measured in accordance with a set of standardized criteria and can be used to compare one power tool with another.

The stated vibration emission levels and stated noise emission values can also be used to make an initial assessment of exposure.

Warning:

The vibration and noise emission levels may vary from the level specified during actual use, depending on the way in which the power tool is used, especially the type of workpiece it is used for.

Keep the noise emissions and vibrations to a minimum.

- Only use appliances which are in perfect working order.
- Service and clean the appliance regularly.
- Adapt your working style to suit the appliance.
- Do not overload the appliance.
- Have the appliance serviced whenever necessary.
- Switch the appliance off when it is not in use.
- Wear protective gloves.

Caution!

Residual risks

Even if you use this electric power tool in accordance with instructions, certain residual risks cannot be ruled out. The following hazards may arise in connection with the equipment's construction and layout:

1. Lung damage if no suitable protective dust mask is used.
2. Damage to hearing if no suitable ear protection is used.
3. Health damage caused by hand-arm vibrations if the equipment is used over a prolonged period or is not properly guided and maintained.

5. Before using for the first time

Warning!

Always remove the battery before making adjustments to the tool.

5.1 Fitting the guard handle (Fig. 3)

The guard handle (Item 9) must be fastened with the assembly screws (Item 12) to both sides of the housing.

5.2 Removing the blade guard hood (Fig. 4)

Remove the blade guard hood by unfolding it.

5.3 Fitting the battery (Fig. 5)

Press the pushlock button (A) of the rechargeable battery and press the rechargeable battery into the mount provided. Make sure that the pushlock button latches in place. To remove the battery, proceed in reverse order!

5.4 Charging the Li battery pack (Fig. 5-6)

1. Remove the battery pack from the handle, pressing the pushlock button (A) downwards to do so.
2. Check that your mains voltage is the same as that marked on the rating plate. Insert the power plug of the charger into the socket outlet. The green LED will then begin to flash.
3. Push the battery pack onto the battery charger.
4. In the section entitled „Charger indicator“ you will find a table with an explanation of the LED indicator on the charger.

If the battery pack fails to charge, check for the following:

- voltage at the power socket
- whether there is good contact at the charging contacts of the charging unit

If the battery pack still fails to charge, send

- the charger and charging adapter
- and the battery pack

to our customer service center.

To ensure that items are properly packaged and delivered when you send them to us, please contact our customer service or the point of sale at which the equipment was purchased.

When shipping or disposing of batteries and cordless tools, always ensure that they are packed individually in plastic bags to prevent short circuits and fires.

To ensure that the battery pack provides long service, you should take care to recharge it promptly. You must recharge the battery pack when you notice that the performance of the device drops.

Never allow the battery pack to become fully discharged. This will cause it to develop a defect.

5.5 Battery capacity indicator (Fig. 7)

Press the button for the battery capacity indicator (B). The battery capacity indicator (C) shows the charge status of the battery using 3 LEDs.

All 3 LEDs are lit:

The battery is fully charged.

2 or 1 LED(s) are lit:

The battery has an adequate remaining charge.

1 LED flashes:

The battery is empty, recharge the battery.

All LEDs blink:

The battery temperature is too low. Remove the battery from the equipment, keep it at room temperature for one day. If the fault reoccurs, this means that the rechargeable battery has undergone exhaustive discharge and is defective. Remove the battery from the equipment. Never use or charge a defective battery.

6. Operation

6.1 Using the equipment

Hold the tool with one hand on the handle (Fig. 1 / Item 8) and the other hand on the grip surface (Fig. 1 / Item 5). Keep a safe distance between this hand and the work area – risk of injury.

6.2 Switching on (Fig. 8-9)

- a) Press the function switch (Item 7a) for one second. A signal will sound and the “ON-STANDBY-OFF” LED (Item 7b) will light up orange (STANDBY Mode).
- b) Press the trigger (Item 6) twice in quick succession. A signal will sound and both the “ON-STANDBY-OFF” LED (Item 7b) and the “CUTTINGWIDTH 35MM” LED will light up green (ON). The tool is now ready for operation. Press the trigger (Item 6) to open the cutting blade.

6.3 Adjusting the opening width (Fig. 8-9)

You can set two different opening widths of the branch cutting blade (35 mm / 25 mm).

- a) 35 mm -> 25 mm: Press the function switch (Item 7a) briefly – the “CUTTINGWIDTH 35MM” LED will go out and the “CUTTING-

WIDTH 25MM" LED will light up.

- b) 25 mm -> 35 mm: Press the function switch (Item 7a) briefly – the "CUTTINGWIDTH 25MM" LED will go out and the "CUTTINGWIDTH 35MM" LED will light up.

6.4 Using the tool (Fig. 8)

Press the trigger (Item 6) to close the cutting blade, release the trigger to open it again to the previously set opening width.

6.5 Switching off (Fig. 8-9)

- a) Press the trigger (Item 6) to close the cutting blade. Hold the trigger. After approx. 5 seconds the "ON-STANDBY-OFF" LED will light up orange (STANDBY Mode).
- b) Press the function switch (Item 7a) for 3 seconds. A signal will sound, the "ON-STANDBY-OFF" LED will light up and the tool will be switched off.

6.6 Finishing the job

Switch off the tool as described in Section 6.5, remove the battery/batteries and fold the blade guard cover over the branch cutting blade.

6.7 Hook (Fig. 1)

You can use the hook (Item 3) to pull branches out of the tree when they have been cut. Keep a safe distance between yourself and the falling branch.

6.8 Additional instructions

- a) If the tool is ready for use but the trigger (Item 6) is not pressed for 30 seconds, the tool will switch automatically from its current status into STANDBY Mode.
- b) The tool will switch off automatically after approx. 10 minutes in STANDBY Mode.
- c) You can switch off the tool by pressing the function switch (Item 7a) and continuing to hold it.
- d) Take account of the maximum cutting capacity (see Technical Data) when cutting branches.
- e) If you try to cut branches that are too thick or too hard for the tool to cut through, the cutting blade will open automatically.

7. Cleaning, maintenance and ordering of spare parts

Hazard!

Always pull out the battery pack before starting any cleaning work.

7.1 Cleaning

- The blades must be cleaned with a soft brush each time after use.
- Keep all safety devices, air vents and the motor housing free of dirt and dust as far as possible. Wipe the equipment with a clean cloth or blow it with compressed air at low pressure.
- We recommend that you clean the device immediately each time you have finished using it.
- Clean the equipment regularly with a moist cloth and some soft soap. Do not use cleaning agents or solvents; these could attack the plastic parts of the equipment. Ensure that no water can seep into the device. The ingress of water into an electric tool increases the risk of an electric shock.

7.2 Maintenance

7.2.1 Lubricating the branch shears blade

The branch shears blade must be lubricated after each use and whenever required. Use universal oil spray.

7.2.2 Resharpener the moving cutting blade (Fig. 1)

If the cutting blade (Item 1) becomes blunt, you can sharpen it yourself (Caution! Wear protective gloves!) or have the blade replaced by the customer services team.

- With the blade fully open, switch off the tool and remove the battery.
- Sharpen the cleaned cutting blade with a suitable grinding tool (e.g. a wet grinding stone, wet grinding paper).
- There are no other parts inside the tool which require maintenance.

7.3 Ordering spare parts and accessories

Please provide the following information when ordering spare parts:

- Type of unit
- Article number of the unit
- ID number of the unit
- Spare part number of the required spare part

For our latest prices and information please go to www.Einhell-Service.com

8. Disposal and recycling

The equipment is supplied in packaging to prevent it from being damaged in transit. The raw materials in this packaging can be reused or recycled. The equipment and its accessories are made of various types of material, such as metal and plastic. Never place defective equipment in your household refuse. The equipment should be taken to a suitable collection center for proper disposal. If you do not know the whereabouts of such a collection point, you should ask in your local council offices.

9. Storage

Store the equipment and accessories in a dark and dry place at above freezing temperature. The ideal storage temperature is between 5 and 30 °C. Store the electric tool in its original packaging.



10. Troubleshooting guide

Danger!

Before troubleshooting, switch off the tool and remove the battery.

The table below contains a list of fault symptoms and explains what you can do to remedy the problem if your tool fails to work properly. If you fail to localize and solve the problem after working through the list, please contact your nearest service workshop.

Fault	Possible cause	Remedy
The tool does not work	<ul style="list-style-type: none"> - The battery is empty - The tool/battery is not correctly inserted 	<ul style="list-style-type: none"> - Charge the battery - Remove the battery and insert again
The tool stops during cutting	<ul style="list-style-type: none"> - The battery is empty - The battery capacity is low - The wood is too hard - The wood diameter is too large 	<ul style="list-style-type: none"> - Charge the battery - Charge the battery - The wood is unsuitable for cutting - The wood is unsuitable for cutting
The cut is not smooth	<ul style="list-style-type: none"> - The cutting blade is blunt or worn 	<ul style="list-style-type: none"> - Replace the cutting blade



11. Charger indicator

Indicator status		Explanations and actions
Red LED	Green LED	
Off	Flashing	<p>Ready for use The charger is connected to the mains and is ready for use; there is no battery pack in the charger</p>
On	Off	<p>Charging The charger is charging the battery pack in quick charge mode. The charging times are shown directly on the charger. Important! The actual charging times may vary slightly from the stated charging times depending on the existing battery charge.</p>
Off	On	<p>The battery is charged and ready for use. (READY TO GO) The unit then changes over to gentle charging mode until the battery is fully charged. To do this, leave the rechargeable battery on the charger for approx. 15 minutes longer. Action: Take the battery pack out of the charger. Disconnect the charger from the mains supply.</p>
Flashing	Off	<p>Adapted charging The charger is in gentle charging mode. For safety reasons the charging is performed less quickly and takes more time. The reasons can be: - The rechargeable battery has not been used for a very long time. - The battery temperature is outside the ideal range. Action: Wait for the charging to be completed; you can still continue to charge the battery pack.</p>
Flashing	Flashing	<p>Fault Charging is no longer possible. The battery pack is defective. Action: Never charge a defective battery pack. Take the battery pack out of the charger.</p>
On	On	<p>Temperature fault The battery pack is too hot (e.g. due to direct sunshine) or too cold (below 0° C). Action: Remove the battery pack and keep it at room temperature (approx. 20° C) for one day .</p>

Disposal

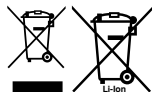

Power tools, rechargeable batteries, accessories and packaging should be sorted for environmental-friendly recycling.

Do not dispose of power tools and batteries/rechargeable batteries into household waste! ☹

Only for EU countries:

According to the Directive 2012/19/EU on waste electrical and electronic equipment and its transposition into national law, power tools that are no longer usable, and, according to the Directive 2006/66/EC, defective or drained batteries must be collected separately and disposed of in an environmentally correct manner.

If disposed incorrectly, waste electrical and electronic equipment may have harmful effects on the environment and human health, due to the potential presence of hazardous substances.

Only for United Kingdom:

According to The Waste Electrical and Electronic Equipment Regulations 2013 (SI 2013/3113) (as amended) and the Waste Batteries and Accumulators Regulations 2009 (SI 2009/890) (as amended), products that are no longer usable must be collected separately and disposed of in an environmentally friendly manner.

The reprinting or reproduction by any other means, in whole or in part, of documentation and papers accompanying products is permitted only with the express consent of the Einhell Germany AG.

Subject to technical changes



Service information

We have competent service partners in all countries named on the guarantee certificate whose contact details can also be found on the guarantee certificate. These partners will help you with all service requests such as repairs, spare and wearing part orders or the purchase of consumables.

Please note that the following parts of this product are subject to normal or natural wear and that the following parts are therefore also required for use as consumables. 

Category	Example
Wear parts*	Battery, cutting blade
Consumables*	
Missing parts	

* Not necessarily included in the scope of delivery!

In the effect of defects or faults, please register the problem on the internet at www.Einhell-Service.com. Please ensure that you provide a precise description of the problem and answer the following questions in all cases:

- Did the equipment work at all or was it defective from the beginning?
- Did you notice anything (symptom or defect) prior to the failure?
- What malfunction does the equipment have in your opinion (main symptom)? Describe this malfunction.

