



DAEWOO

POWER PRODUCTS

DALD18-M1 / DALD18-P1

Lithium impact drill



USER'S MANUAL

www.daewoopowerproducts.com

Manufactured under license of Daewoo International Corporation, Korea

INDEX

1. SAFETY INSTRUCTIONS	3
2. GENERAL POWER TOOL SAFETY WARNINGS	3
3. ADDITIONAL SAFETY WARNINGS FOR DRILLS AND SCREW DRIVERS	5
4. MACHINE INFORMATION	5
5. TECHNICAL SPECIFICATIONS	6
6. DESCRIPTION	6
7. ASSEMBLY	7
8. OPERATION	7
9. MAINTENANCE	8
10. ENVIROMENT	8
WARRANTY	9

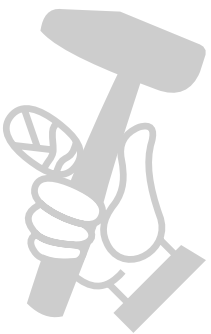

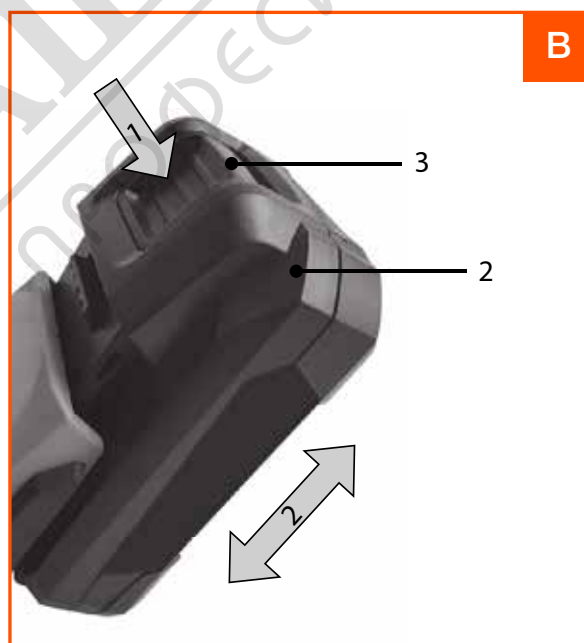









1. SAFETY INSTRUCTIONS

Read the enclosed safety warnings, the additional safety warnings and the instructions. Failure to follow the safety warnings and the instructions may result in electric shock, fire and/or serious injury. Save the safety warnings and the instructions for future reference.

The following symbols are used in the user manual or on the product:

-  Read the user manual.
-  Denotes risk of personal injury, loss of life or damage to the tool in case of non-observance of the instructions in this manual.
-  Risk of electric shock.
-  Variable electronic speed.
-  Rotation, left/right.
-  Do not use in rain.
-  Do not dispose of the product in unsuitable containers.
-  The product is in accordance with the applicable safety standards in the European directives

2. GENERAL POWER TOOL SAFETY WARNINGS

 **WARNING!** Read all safety warnings and all instructions. Failure to follow the warnings and instructions may result in electric shock, fire and/or serious injury.

Save all warnings and instructions for future reference.

The term “power tool” in the warnings refers to your mains-operated (corded) power tool or battery-operated (cordless) power tool.

1) Work area safety

- a) Keep work area clean and well lit. Cluttered or dark areas invite accidents.
- b) Do not operate power tools in explosive atmospheres, such as in the presence of flammable liquids, gases or dust. Power tools create sparks which may ignite the dust or fumes.
- c) Keep children and bystanders away while operating a power tool. Distractions can cause you to lose control.

2) Electrical safety

- a) Power tool plugs must match the outlet. Never modify the plug in any way. Do not use any adapter plugs with earthed (grounded) power tools. Unmodified plugs and matching outlets will reduce risk of electric shock.
- b) Avoid body contact with earthed or grounded surfaces, such as pipes, radiators, ranges and refrigerators. There is an increased risk of electric shock if your body is earthed or grounded.

- c) Do not expose power tools to rain or wet conditions. Water entering a power tool will increase the risk of electric shock.
- d) Do not abuse the cord. Never use the cord for carrying, pulling or unplugging the power tool. Keep cord away from heat, oil, sharp edges or moving parts. Damaged or entangled cords increase the risk of electric shock.
- e) When operating a power tool outdoors, use an extension cord suitable for outdoor use. Use of a cord suitable for outdoor use reduces the risk of electric shock.
- f) If operating a power tool in a damp location is unavoidable, use a residual current device (RCD) protected supply. Use of an RCD reduces the risk of electric shock.

3) Personal safety

- a) Stay alert, watch what you are doing and use common sense when operating a power tool. Do not use a power tool while you are tired or under the influence of drugs, alcohol or medication. A moment of inattention while operating power tools may result in serious personal injury.
- b) Use personal protective equipment. Always wear eye protection. Protective equipment such as dust mask, non-skid safety shoes, hard hat, or hearing protection used for appropriate conditions will reduce personal injuries.
- c) Prevent unintentional starting. Ensure the switch is in the off-position before connecting to power source and/or battery pack, picking up or carrying the tool. Carrying power tools with your finger on the switch or energising power tools that have the switch on invites accidents.
- d) Remove any adjusting key or wrench before turning the power tool on. A wrench or a key left attached to a rotating part of the power tool may result in personal injury.
- e) Do not overreach. Keep proper footing and balance at all times. This enables better control of the power tool in unexpected situations.
- f) Dress properly. Do not wear loose clothing or jewellery. Keep your hair, clothing and gloves away from moving parts. Loose clothes, jewellery or long hair can be caught in moving parts.
- g) If devices are provided for the connection of dust extraction and collection facilities, ensure these are connected and properly used. Use of dust collection can reduce dust related hazards.

4) Power tool use and care

- a) Do not force the power tool. Use the correct power tool for your application. The correct power tool will do the job better and safer at the rate for which it was designed.
- b) Do not use the power tool if the switch does not turn it on and off. Any power tool that cannot be controlled with the switch is dangerous and must be repaired.
- c) Disconnect the plug from the power source and/or the battery pack from the power tool before making any adjustments, changing accessories, or storing power tools. Such preventive safety measures reduce the risk of starting the power tool accidentally.
- d) Store idle power tools out of the reach of children and do not allow persons unfamiliar with the power tool or these instructions to operate the power tool. Power tools are dangerous in the hands of untrained users.
- e) Maintain power tools. Check for misalignment or binding of moving parts, breakage of parts and any other condition that may affect the power tool's operation. If damaged, have the power tool repaired before use. Many accidents are caused by poorly maintained power tools.
- f) Keep cutting tools sharp and clean. Properly maintained cutting tools with sharp cutting edges are less likely to bind and are easier to control.
- g) Use the power tool, accessories and tool bits etc. in accordance with these instructions, taking into account the working conditions and the work to be performed. Use of the power tool for operations different from those intended could result in a hazardous situation.

5) Battery tool use and care

- a) Recharge only with the charger specified by the manufacturer. A charger that is suitable for one type of battery pack may create a risk of fire when used with another battery pack.
- b) Use power tools only with specifically designated battery packs. Use of any other battery packs may create a risk of injury and fire.
- c) When battery pack is not in use, keep it away from other metal objects, like paper clips, coins, keys, nails, screws or other small metal objects that can make a connection from one terminal to another. Shorting the battery terminals together may cause burns or a fire.
- d) Under abusive conditions, liquid may be ejected from the battery; avoid contact. If contact accidentally occurs, flush with water. If liquid contacts eyes, additionally seek medical help. Liquid ejected from the battery may cause irritation or burns.

6) Service

- a) Have your power tool serviced by a qualified repair person using only identical replacement parts. This will ensure that the safety of the power tool is maintained.

3. ADDITIONAL SAFETY WARNINGS FOR DRILLS AND SCREW DRIVERS

- a) Wear ear protectors when impact drilling. Exposure to noise can cause hearing loss.
- b) Hold power tool by insulated gripping surfaces when performing an operation where the cutting accessory or fastener may contact hidden wiring. Cutting accessory and fasteners contacting a “live” wire may make exposed metal parts of the power tool “live” and could give the operator an electric shock.
- c) Use auxiliary handle(s), if supplied with the tool. Loss of control can cause personal injury.
- d) Use appropriate detectors to determine if utility lines are hidden in the work area or call the local utility company for assistance. Contact with electric lines can lead to fire and electric shock. Damaging a gas line can lead to explosion. Penetrating a water line causes property damage.
- e) Switch off the power tool immediately when the tool insert jams. Be prepared for high reaction torque that can cause kickback. The tool insert jams when:
 - the power tool is subject to overload or.
 - it becomes wedged in the workpiece.
- f) Hold the machine with a firm grip. High reaction torque can briefly occur while driving in and loosening screws.
- g) Secure the workpiece. A workpiece clamped with clamping devices or in a vice is held more secure than by hand.
- h) Always wait until the machine has come to a complete stop before placing it down. The tool insert can jam and lead to loss of control over the power tool.

4. MACHINE INFORMATION

Intended use

This cordless drill is intended for driving in and loosening screws as well as for drilling in wood, metal and plastic.

5. TECHNICAL SPECIFICATIONS

DALD18-M1

Power: 18 V

No load speed: 0-400 / 0-1500 rpm

Max torque: 44 N.m

Chuck: 13 mm, single sleeve, metal and keyless

Speeds: 2

Functions: Hammer function and spindle lock.

Includes: LED light and belt hook.

For both models:

Sound pressure level LPA 89.9 dB(A), K=3dB(A)

Sound power level LWA 99.9 dB(A), K=3dB(A)

DALD18-M1: Vibration: 14,265 m²/s

DALD18-P1: Vibration: 1,746 m²/s

DALD18-P1 (no hammer function)

Power: 18 V

No load speed: 0-350 / 0-1300 rpm

Max torque: 25 N.m

Chuck: 10 mm, single sleeve, plastic and keyless

Torque setting: 21 + 1

Speeds: 2

Function: Spindle lock.

Includes: LED light and belt hook.

The following charger of the can be used to charge these batteries. CD802AA Quick charger
The batteries of the DAEWOO POWER 18 V battery platform are interchangeable with all the DAEWOO POWER 18 V battery platform tools.

Vibration level

The vibration emission level stated in this instruction manual has been measured in accordance with a standardized test given in EN60745; it may be used to compare one tool with another and as a preliminary assessment of exposure to vibration when using the tool for the applications mentioned.

- Using the tool for different applications, or with different or poorly maintained accessories, may significantly increase the exposure level.
- The times when the tool is switched off or when it is running but not actually doing the job, may significantly reduce the exposure level.

Protect yourself against the effects of vibration by maintaining the tool and its accessories, keeping your hands warm, and organizing your work patterns.

6. DESCRIPTION

The numbers in the text refer to the diagrams on page 2.

1. Machine
2. Battery (not included)
3. Battery unlock button
4. Work light
5. On / off switch
6. Torque adjustment ring
7. Chuck
8. Gear selection switch
9. Direction switch
10. Belt hook

7. ASSEMBLY

 Before any work on the power tool, remove the battery.

 The battery must be charged before first use.

Inserting the battery into the machine (Fig. B)

Ensure that the exterior of the battery is clean and dry before connecting to the charger or machine.

1. Insert the battery (2) into the base of the machine as shown in Fig. B.
2. Push the battery further forward until it clicks into place.

Removing the battery from the machine (Fig. B)

1. Push the battery unlock button (3)
2. Pull the battery out of the machine like shown in Fig. B.



Fitting and removing drills or screwdriver bits (Fig. A)

The drill chuck (7) is suitable for drills and screwdriver bits with round shaft as well as hexagonal shaft.

1. Hold the machine firmly with one hand.
2. Open the drill chuck (7) by rotating the chuck with your other hand in clockwise direction until it is opened far enough for the bit to slide in.
3. Insert the shaft of the drill or screwdriver bit.
4. Tighten the drill chuck again by firmly rotating the chuck (7) counterclockwise.
5. Check if the bit is centered well by shortly activating the machine's on/off switch.

8. OPERATION

Adjusting the gears (Fig.A)

-  Never switch gears when the motor is running, this will damage your machine.
-  Never put switch in the middle between both positions, this will damage your machine.

The machine has 2 drill speeds, which can be adjusted by sliding the gear switch (8) forward or backwards. The number on the gear switch (8) shows which position is chosen.

- Position 1: For slow drilling, large drilling diameter or screw driving. The machine has high power at a low speed.
- Position 2: For fast drilling or small drilling diameter.

Adjusting the direction of rotation (Fig. A)

- Set the direction switch (9) to position in order to drive screws or to use it for drilling.
- Set the direction switch (9) to position in order to remove screws.

Switching the machine on and off (Fig. A)

The on/off switch (5) is used for activating the machine and adjusting rotation speed.

- Pressing the on/off switch (5) will activate the machine, the further the switch is being pushed, the faster the drill will turn.
- Releasing the on/off switch (5) will stop the machine.

- Move the direction reversing switch (9) to the middle position to lock the movement of the on/off switch.

Adjusting the torque (Fig. A)

The machine has 21 different torque settings and a special drill mode to set the power being transmitted to the chuck. By rotating the torque adjustment ring (6), screws can be driven to a predetermined depth, which is ideal for repetitive work. The higher the number, the more torque will be transmitted.

- Select a low setting for small screws or soft work material.
- Select a high setting for large screws, hard work materials and when removing screws.
- You should preferably choose a setting as low as possible when driving screws. Select a higher setting if the motor slips before the screw is fully tightened.
- For drilling, turn the torque adjustment ring (6) to the setting for drilling () by fully turning it counterclockwise.



Ensure that the direction switch (9) is always set to  during drilling.



The machine is equipped with electronic overload protection function. When the machine gets overloaded it will shut down automatically. When this happens, please wait for a few seconds to let the overload protection reset itself.

9. MAINTENANCE

Before cleaning and maintenance, always switch off the machine and remove the battery pack from the machine.

Clean the machine casings regularly with a soft cloth, preferably after each use. Make sure that the ventilation openings are free of dust and dirt. Remove very persistent dirt using a soft cloth moistened with soapsuds. Do not use any solvents such as gasoline, alcohol, ammonia, etc. Chemicals such as these will damage the synthetic components.

10. ENVIRONMENT



Faulty and/or discarded electrical or electronic apparatus have to be collected at the appropriate recycling locations.

Only for EC countries

Do not dispose of power tools into domestic waste.

According to the European Guideline 2012/19/EC for Waste Electrical and Electronic Equipment and its implementation into national right, power tools that are no longer usable must be collected separately and disposed of in an environmentally friendly way.



DAEWOO
POWER PRODUCTS



МАГАЗИН МАЙСТОРА®
БАШ ПРОФЕСИОНАЛНИ РЕШЕНИЯ

www.daewoopowerproducts.com

Manufactured under license of Daewoo International Corporation, Korea