



TC-AC 190/6/8 OF

D	Originalbetriebsanleitung Kompressor	FIN	Alkuperäiskäyttöohje Kompressor
GB	Original operating instructions Compressor	SLO	Originalna navodila za uporabo Kompressor
F	Instructions d'origine Compresseur	H	Eredeti használati utasítás Kompresszor
I	Istruzioni per l'uso originali Compressore	RO	Instrucțiuni de utilizare originale Compresor
DK/ N	Original betjeningsvejledning Kompressor	GR	Πρωτότυπες Οδηγίες χρήσης Συμπιεστής
S	Original-bruksanvisning Kompressor	P	Manual de instrucções original Compressor
CZ	Originální návod k obsluze Kompressor	HR/ BIH	Originalne upute za uporabu Kompressor
SK	Originálny návod na obsluhu Kompresor	RS	Originalna uputstva za upotrebu Kompresor
NL	Originele handleiding Compressor	PL	Instrukcja oryginalną Kompresor
E	Manual de instrucciones original Compresor	TR	Orijinal Kullanma Talimatı Kompresör
		EE	Originaalkasutusjuhend Kompressor

13



Art.-Nr.: 40.206.55

I.-Nr.: 21023

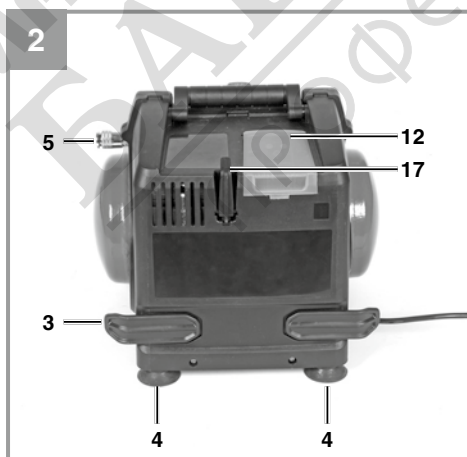
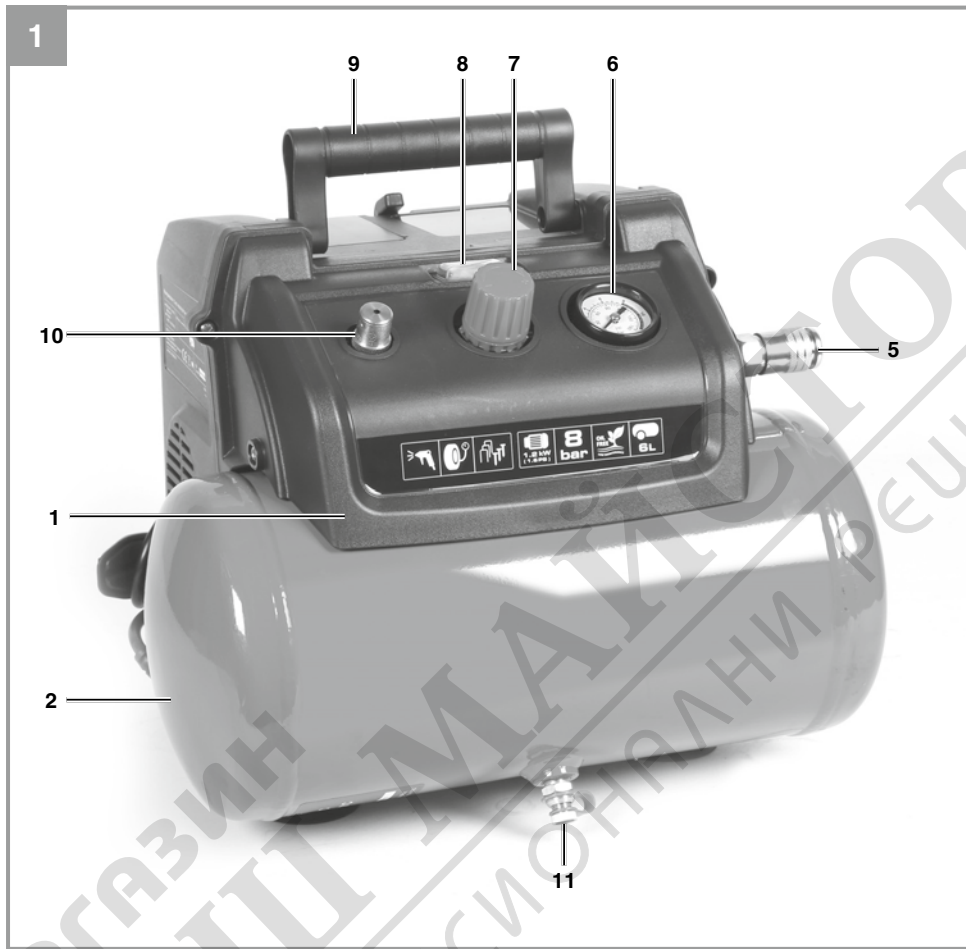

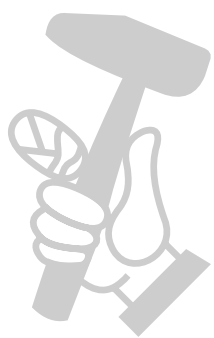
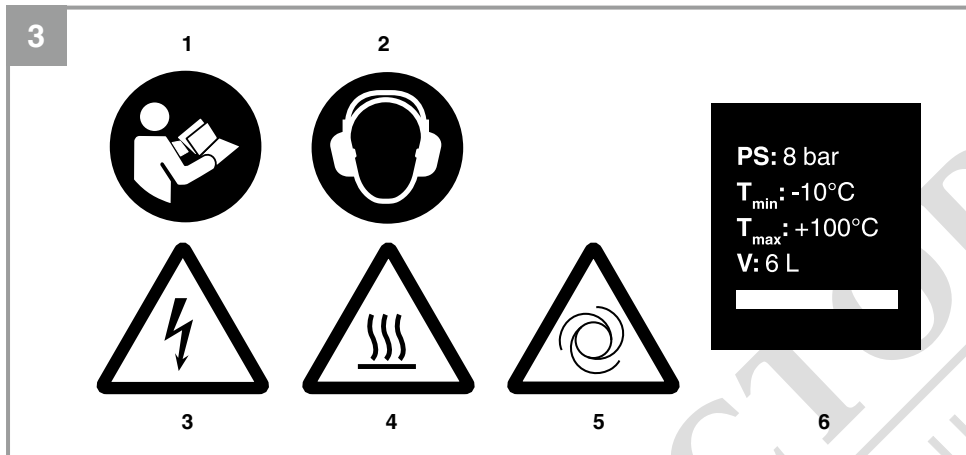

Danger!

When using the equipment, a few safety precautions must be observed to avoid injuries and damage. Please read the complete operating instructions and safety regulations with due care. Keep this manual in a safe place, so that the information is available at all times. If you give the equipment to any other person, hand over these operating instructions and safety regulations as well. We cannot accept any liability for damage or accidents which arise due to a failure to follow these instructions and the safety instructions.

Explanation of the symbols used (see Fig. 3)

1. **Danger!** - Read the operating instructions to reduce the risk of injury.
2. **Caution! Wear ear-muffs.** The impact of noise can cause damage to hearing.
3. **Beware of electrical voltage!**
4. **Beware of hot parts!**
5. **Warning!** The unit will start up automatically without warning if the pressure drops below cut-in pressure!
6. **PS:** Max. operating pressure
 T_{max} : Max. operating temperature
 T_{min} : Min. operating temperature
V: Tank capacity

1. Safety regulations

The corresponding safety information can be found in the enclosed booklet.

Danger!**Read all safety regulations and instructions.**

Any errors made in following the safety regulations and instructions may result in an electric shock, fire and/or serious injury.

Keep all safety regulations and instructions in a safe place for future use.

This appliance is not intended for use by persons (including children) with reduced physical, sensory or mental capabilities, or lack of experience and knowledge, unless they have been given supervision or instruction concerning use of the appliance by a person responsible for their safety. Children should be supervised to ensure that they do not play with the appliance.

2. Layout and items supplied**2.1 Layout (Fig. 1-3)**

1. Housing cover
2. Pressure tank
3. Hook for cable store
4. Foot
5. Quick-lock coupling (regulated compressed air)
6. Pressure gauge (for reading the set pressure)
7. Pressure regulator
8. ON/OFF switch
9. Transport handle
10. Safety valve
11. Drainage screw for condensation water
12. Storage compartment for 8-piece adapter set
17. Storage hook for tire pressure gauge

2.2 Items supplied

Please check that the article is complete as specified in the scope of delivery. If parts are missing, please contact our service center or the sales outlet where you made your purchase at the latest within 5 working days after purchasing the product and upon presentation of a valid bill of purchase. Also, refer to the warranty table in the service information at the end of the operating instructions.

- Open the packaging and take out the equipment with care.
- Remove the packaging material and any packaging and/or transportation braces (if available).
- Check to see if all items are supplied.
- Inspect the equipment and accessories for transport damage.
- If possible, please keep the packaging until the end of the guarantee period.

Danger!

The equipment and packaging material are not toys. Do not let children play with plastic bags, foils or small parts. There is a danger of swallowing or suffocating!

- Original operating instructions
- Safety information

3. Proper use

The compressor is designed for generating compressed air for tools operated by compressed air.

The equipment is to be used only for its prescribed purpose. Any other use is deemed to be a case of misuse. The user / operator and not the manufacturer will be liable for any damage or injuries of any kind caused as a result of this.

Please note that our equipment has not been designed for use in commercial, trade or industrial applications. Our warranty will be voided if the machine is used in commercial, trade or industrial businesses or for equivalent purposes.

4. Technical data

Mains connection:	220-240 V ~ 50 Hz
Motor rating kW:	1.2
Compressor speed min ⁻¹ :	3800
Operating pressure bar:	8
Pressure vessel capacity (in liters):	6
Theoretical suction rate l/min.:	190
Output (compressed air) at 7 bar:	55 liters/min
Output (compressed air) at 4 bar:	77 liters/min
Sound power level L_{WA} in dB:	97
Uncertainty K_{WA}	0.65 dB
Sound pressure level L_{pA} in dB:	77
Uncertainty K_{pA}	0.65 dB
Protection type:	IP20
Weight of the unit in kg:	approx. 8.8

Danger! **Noise**

The noise emission values were measured in accordance with EN ISO 3744.

5. Before starting the equipment

Warning!

Before you connect the equipment to the mains supply make sure that the data on the rating plate are identical to the mains data.

- Examine the machine for signs of transit damage. Report any damage immediately to the company which delivered the compressor.

- The compressor should be set up near the working consumer.
- Avoid long air lines and long supply lines (extensions).
- Make sure the intake air is dry and dust-free.
- Do not set up the compressor in damp or wet rooms.
- The compressor may only be used in suitable rooms (with good ventilation and an ambient temperature from +5°C to +40°C). There must be no dust, acids, vapors, explosive gases or inflammable gases in the room.
- The compressor is designed to be used in dry rooms. It is prohibited to use the compressor in areas where work is conducted with sprayed water.
- The equipment must be set up where it can stand securely.
- Use flexible hoses in order to prevent transmitting unacceptable loads to the pipeline system at the connection between the compressor system and the pipeline system.
- It is essential to use separators, traps and drains which process the liquids produced by the compressor before the compressor system is put into operation.
- Supply hoses at pressures above 7 bar should be equipped with a safety cable (e.g. a wire rope).

6. Assembly and starting

Important!

You must fully assemble the equipment before using it for the first time.

6.1 Mains connection

- Long supply cables, extensions, cable reels etc. cause a drop in voltage and can impede motor start-up.
- At low temperatures below +5°C, sluggishness may make starting difficult or impossible.

6.2 ON/OFF switch (Fig. 1)

To switch on the equipment, set the On/Off switch (8) to position 1.

To switch off the equipment, move the On/Off switch (8) to position 0.

6.3 Setting the pressure (Fig. 1)

- You can adjust the pressure on the pressure gauge (6) using the pressure regulator (7).

- The set pressure can be drawn from the quick-lock coupling (5).

6.4 Setting the pressure switch

The pressure switch is set at the factory.
Cut-in pressure approx. 6 bar
Cut-out pressure approx. 8 bar

7. Replacing the power cable

Danger!

If the power cable for this equipment is damaged, it must be replaced by the manufacturer or its after-sales service or similarly trained personnel to avoid danger.

8. Cleaning, maintenance and ordering of spare parts

Danger!

Pull the power plug before doing any cleaning and maintenance work on the appliance.

Warning!

Wait until the compressor has completely cooled down. Risk of burns!

Warning!

Always depressurize the tank before carrying out any cleaning and maintenance work.

Danger!

After use, always switch off the equipment immediately and pull out the power plug.

8.1 Cleaning

- Keep the safety devices free of dirt and dust as far as possible. Wipe the equipment with a clean cloth or blow it with compressed air at low pressure.
- We recommend that you clean the appliance immediately after you use it.
- Clean the appliance regularly with a damp cloth and some soft soap. Do not use cleaning agents or solvents; these may be aggressive to the plastic parts in the appliance. Ensure that no water can get into the interior of the appliance.
- You must disconnect the hose and any spraying tools from the compressor before cleaning. Do not clean the compressor with

water, solvents or the like.

8.2 Condensed water (Fig. 1)

Important! To ensure a long service life of the pressure vessel (2), drain off the condensed water by opening the drain screw (11) each time after using.

Check the pressure vessel for signs of rust and damage each time before using. Do not use the compressor with a damaged or rusty pressure vessel. If you discover any damage, please contact the customer service workshop.

8.3 Safety valve (10)

The safety valve has been set for the highest permitted pressure of the pressure vessel. It is prohibited to adjust the safety valve or remove its seal. Actuate the safety valve from time to time to ensure that it works when required. To do so, open the screw cap of the valve while the tank is under pressure. Once the screw cap has been fully opened you must pull it to let air escape through the valve. Then screw the cap fully back in place.

8.4 Storage

Warning!

Pull the mains plug out of the socket and ventilate the appliance and all connected pneumatic tools. Switch off the compressor and make sure that it is secured in such a way that it cannot be started up again by any unauthorized person.

Warning!

Store the compressor only in a dry location which is not accessible to unauthorized persons. Always store upright, never tilted!

8.5 Transport

- Transport the equipment only by carrying it by the transport handle.
- Protect the equipment against unexpected knocks and vibrations.

8.6 Ordering replacement parts:

Please quote the following data when ordering replacement parts:

- Type of machine
- Article number of the machine
- Identification number of the machine
- Replacement part number of the part required

For our latest prices and information please go to www.Einhell-Service.com

9. Disposal and recycling

The equipment is supplied in packaging to prevent it from being damaged in transit. The raw materials in this packaging can be reused or recycled. The equipment and its accessories are made of various types of material, such as metal and plastic. Never place defective equipment in your household refuse. The equipment should be taken to a suitable collection center for proper disposal. If you do not know the whereabouts of such a collection point, you should ask in your local council offices.

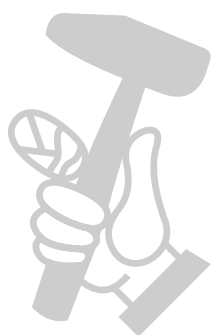

МАГАЗИН
БАШ МАЙСТОРА[®]
ПРОФЕСИОНАЛНИ РЕШЕНИЯ

10. Possible causes of failure

Problem	Cause	Solution
The compressor does not start.	<ol style="list-style-type: none"> 1. No supply voltage. 2. Insufficient supply voltage. 3. Outside temperature is too low. 4. Motor is overheated. 	<ol style="list-style-type: none"> 1. Check the supply voltage, the power plug and the socket-outlet. 2. Make sure that the extension cable is not too long. Use an extension cable with large enough wires. 3. Never operate with an outside temperature of below +5° C. 4. Allow the motor to cool down. If necessary, remedy the cause of the overheating.
The compressor starts but there is no pressure.	<ol style="list-style-type: none"> 1. The non-return valve leaks. 2. The seals are damaged. 3. The drain plug for condensation water leaks. 	<ol style="list-style-type: none"> 1. Have a service center replace the non-return valve. 2. Check the seals and have any damaged seals replaced by a service center. 3. Tighten the screw by hand. Check the seal on the screw and replace if necessary.
The compressor starts, pressure is shown on the pressure gauge, but the tools do not start.	<ol style="list-style-type: none"> 1. The hose connections have a leak. 2. A quick-lock coupling has a leak. 3. Insufficient pressure set on the pressure regulator. 	<ol style="list-style-type: none"> 1. Check the compressed air hose and tools and replace if necessary. 2. Check the quick-lock coupling and replace if necessary. 3. Increase the set pressure with the pressure regulator.

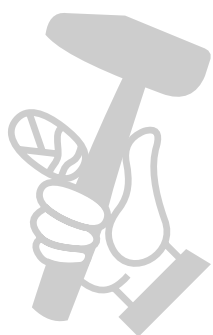



For EU countries only

Never place any electric power tools in your household refuse.

To comply with European Directive 2012/19/EC concerning old electric and electronic equipment and its implementation in national laws, old electric power tools have to be separated from other waste and disposed of in an environment-friendly fashion, e.g. by taking to a recycling depot.

Recycling alternative to the return request:

As an alternative to returning the equipment to the manufacturer, the owner of the electrical equipment must make sure that the equipment is properly disposed of if he no longer wants to keep the equipment. The old equipment can be returned to a suitable collection point that will dispose of the equipment in accordance with the national recycling and waste disposal regulations. This does not apply to any accessories or aids without electrical components supplied with the old equipment.

Please note that batteries and lamps (e.g. light bulbs) must be removed from the tool before it is disposed of.

The reprinting or reproduction by any other means, in whole or in part, of documentation and papers accompanying products is permitted only with the express consent of the Einhell Germany AG.

Subject to technical changes

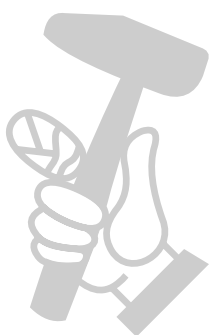

Service information

We have competent service partners in all countries named on the guarantee certificate whose contact details can also be found on the guarantee certificate. These partners will help you with all service requests such as repairs, spare and wearing part orders or the purchase of consumables.

Please note that the following parts of this product are subject to normal or natural wear and that the following parts are therefore also required for use as consumables.

Category	Example
Wear parts*	V-belt, air filter
Consumables*	
Missing parts	

* Not necessarily included in the scope of delivery!

In the effect of defects or faults, please register the problem on the internet at www.Einhell-Service.com. Please ensure that you provide a precise description of the problem and answer the following questions in all cases:

- Did the equipment work at all or was it defective from the beginning?
- Did you notice anything (symptom or defect) prior to the failure?
- What malfunction does the equipment have in your opinion (main symptom)? Describe this malfunction.



Warranty certificate

Dear Customer,

All of our products undergo strict quality checks to ensure that they reach you in perfect condition. In the unlikely event that this equipment develops a fault, please contact our service department at the address shown on this guarantee card. You can also contact us by telephone using the service number shown. Please note the following terms under which guarantee claims can be made:

1. These guarantee terms apply solely to consumers, i.e. natural persons, who do not want to use this product in connection with either their commercial or other self-employed activities. These guarantee terms regulate additional guarantee services which the undermentioned manufacturer promises to buyers of its new products in addition to their statutory rights of guarantee. Your statutory rights of guarantee are not affected by this guarantee. Our guarantee is free of charge to you.
2. The guarantee services cover only defects due to material or manufacturing faults on the new product which you have bought in the European Union from the undermentioned manufacturer and are limited to either the rectification of said defects or the replacement of the product, whichever we prefer. Please note that only equipment under the brand name "Professional" has been designed for use in commercial, trade or professional applications. For all other products the guarantee is invalidated if the equipment is used within the guarantee period in commercial, trade or industrial applications or for other equivalent activities.
3. Our guarantee does not cover:
 - Damage to the equipment caused by failure to comply with the installation/assembly instructions or by unprofessional installation; damage caused by failure to comply with the operating instructions (e.g. connection to the wrong mains voltage or current type); damage caused by failure to comply with the maintenance and safety regulations; damage caused by exposing the equipment to abnormal environmental conditions; damage resulting from poor care and maintenance.
 - Damage to the equipment caused by misuse or incorrect applications (e.g. overloading the equipment or using non-approved attachments or accessories); damage caused by foreign bodies (e.g. sand, stones, dust, ...) getting inside the equipment. Damage in transit; damage caused by force or external influences (e.g. by dropping the equipment).
 - Damage to the equipment or parts of the equipment which is owed to use-related, normal or otherwise natural wear. For example, batteries and battery packs are manufactured with a cycle limit for design-related reasons. Wear is negatively influenced in particular by load demands and charging speeds as well as exposure to heat, cold, vibration and impact.
4. The guarantee is valid for a period of 2 years starting from the purchase date of the equipment. Guarantee claims must be submitted before the end of the guarantee period and within two weeks of the defect being noticed. No guarantee claims will be accepted after the end of the guarantee period. The original guarantee period remains applicable to the equipment even if repairs are carried out or parts are replaced. In such cases, the work performed or parts fitted will not result in an extension of the guarantee period, and no new guarantee will become active for the work performed or for any replacement parts fitted. This also applies if on-site service is used.
5. To assert your guarantee claim, register the defective equipment at: www.Einhell-Service.com. You will need to provide proof of purchase of the new item of equipment. Equipment returned without such proof or without a rating plate are excluded from the guarantee services because of the lack of traceability. If the defect is covered by our guarantee, then either the item in question will be repaired immediately and returned to you or we will send you a new replacement.
6. If you have taken the equipment with you to a different EU country than where you bought it, we will arrange for a local service partner to provide the guarantee services. If you take the equipment outside the EU, the guarantee will not apply.

Of course, we are also happy to offer a chargeable repair service for any defects which are not covered or no longer covered by the scope of this guarantee. To take advantage of this service, please send the equipment to our service address. We draw attention to the restrictions of this guarantee concerning wear parts, consumables and missing parts as presented in the service information included in this operating manual.

Warrantor/ Service:

Einhell UK Ltd, Unit 10, 1st Floor, Champion's Business Park, Arrowe Brook Road, Upton, Wirral, CH49 0UQ