

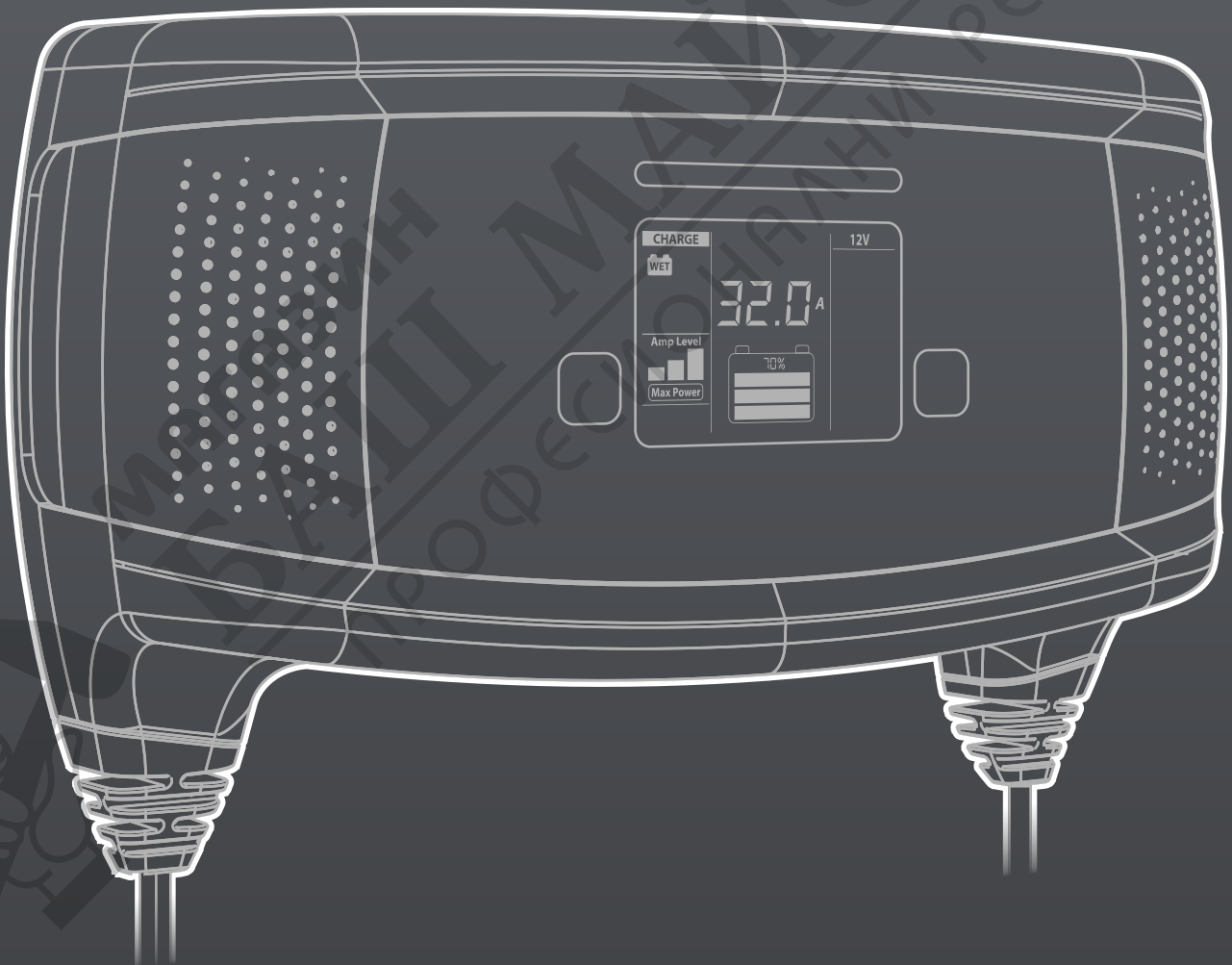

Battery chargers Maintainers

XD | 4
8
16
24
32



XD line

MODERN, COMPACT AND MULTI-FUNCTION

BATTERY CHARGERS –MAINTAINER - TESTER: ALL IN ONE

The XD line multi-function battery chargers and maintainers represents the most modern solution existing today in the automotive market for the charging management and the batteries' maintenance in the automotive field, completed by the function of battery and alternator test. Compact, ergonomic, functional and easy-to-use, they are mainly aimed at users who look for a multi-function high-quality product.

The completeness of the XD range meets all the needs of the demanding private user, of the small workshop and of the big dealer. They develop powers **from 4 to 32A** and are equipped with various programs able to manage all the batteries on the today's market, including Lithium. The advanced functions of Recovery, Showroom, Battery change and Power supply for the diagnostic operations make the XD models a complete and innovative product.



Quality and Reliability are key prerogatives to operate in complete safety, both in car dealerships and workshops.

The new range of products of the **LAB** division represents the best of the technological development in the aftermarket, **automotive** and industrial field. Charge, maintenance, stabilized power supply, starting and diagnostic are the main technical functions to support the electrical system and the battery of the vehicle.

LAB represents for DECA the premium line of more professional products. Born to fulfill this specific request, LAB stands out for its prerogatives of **quality** and **reliability**, thus aiming at demanding and specialized customers.

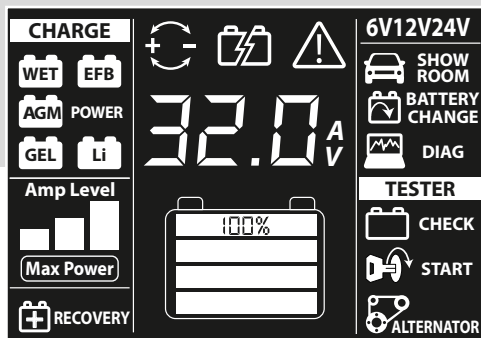

The charging parameters can be set through the intuitive control panel equipped with a “pure white” backlight **digital display**, which allows clear and quick reading. A led bar with an intentionally increased size, easy to be seen even from a distance, indicates the charge status of the battery.

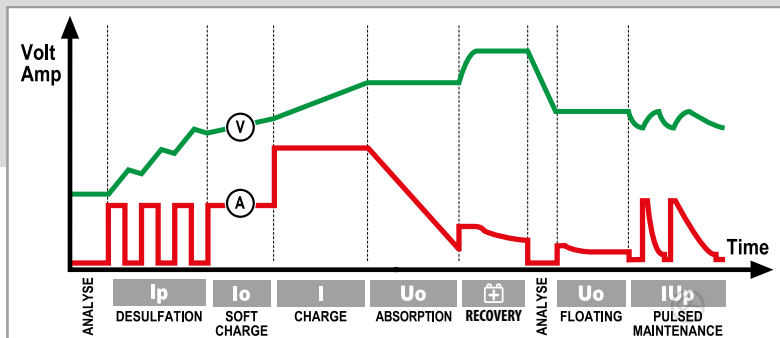

The charge is completely automatic and optimized by **9 alternating steps** of charge and analysis managed by microprocessor, which constantly monitors the parameters of voltage and current absorbed by the battery. The desulfation cycle automatically activates in the initial phase, by advancing the charge to the next step only if the voltage and current parameters are suitable.



They are suited to recharging and maintenance of batteries: **WET**, lead-acid free electrolyte; **EFB** (start & stop); **AGM** (Absorbent Glass Mat) absorbed electrolyte between the plates; **AGM Power** Deep cycle and Spiral for intensive use (start & stop) (XD16, XD24, XD32 models); **GEL**; **Li** lithium iron phosphate (LiFePO4).

To try to recover Lead-acid Wet batteries with very low voltage due to deep discharge, the **Recovery** function can be used. It is a special reconditioning function through constant current and (controlled) high voltage cycles, which runs the mixing of the acid inside the battery, reactivating its chemistry as a result of the induced electrolysis cycle.

 XD4 and XD8 models have an optimized charging cycle voltage for cold climates.



Electric vehicles, both full electric and hybrid, are equipped with a “12V” low voltage battery to supply the electrical system in the starting phases, in the comfort and safety functions, for the door opening and closing, for the functioning of the alarm system. All XD models are suitable for the **recharge of the auxiliary battery**.

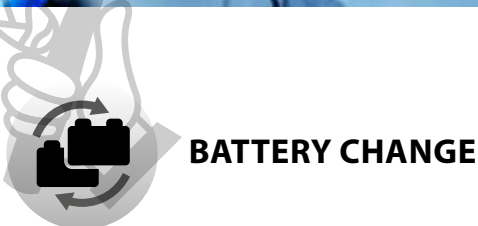

BATTERY CHANGE

During the replacement of the battery, XD battery chargers become a **power supply** able to deliver the current required for the functioning of the vehicles’ electronics. In particular, it is useful as a Memory Saver in order not to lose the data of the control units.



TOTAL PROTECTION

The microprocessor control allows to keep the battery charger connected to the vehicle’s battery even for long periods, without danger of damaging it and without worrying about disconnecting the charger’s terminals. They are also **protected** by: short circuit, reverse polarity, overload, overtemperature, incorrect voltage of the battery and casual contact of the clamps.

XD 4 6/12V - 4A



HANGING STRAP

CABLES ORGANIZER

1 - 2 - 4A (6V)
1 - 2 - 4A (12V)
4 ▲ 90Ah
130Ah (maintenance)



Included

XD 8 12V-8A / 24V-4A



HANGING STRAP

CABLES ORGANIZER

2 - 4 - 8A (12V)
1 - 2 - 4A (24V)
4 ▲ 180Ah
260Ah (maintenance)



Included

XD 16 12V-16A / 24V-8A



2 - 4 - 8 - 16A (12V)
2 - 4 - 8A (24V)
8 ▲ 340Ah
500Ah (maintenance)



XD 24 12V-24A / 24V-12A



2 - 8 - 12 - 24A (12V)
2 - 8 - 12A (24V)
8 ▲ 500Ah
750Ah (maintenance)

XD 32 12V - 32A



2 - 8 - 16 - 32A (12V)
8 ▲ 680Ah
1000Ah (maintenance)



CABLES ORGANIZER



WALL MOUNTING



IN THE CAR SHOWROOM

Modern vehicles in the showroom need to be permanently powered by an external power source to compensate for the absorption of electrical loads connected to the battery activated during the demonstration of the vehicle with the engine off or to keep some functions active (for example the headlights on) during the closing period of the showroom. The XD models, with their low height of few centimeters and detachable cables, can be placed under any type of vehicle.

XD32 model is the best choice.

- **Showroom function**

IN THE WORKSHOP

During the diagnostic operations for the anomaly research, in the setting or updating stages of the ECU (electronic control unit), the voltage of the vehicle's system must not fall below certain threshold levels.









- **DIAG Function**

USED AS A TESTER

The battery charger, set in TESTER mode, provides the voltage values of the tests performed related to the following components: battery, starter motor and vehicle alternator. The values are showed on the digital display, together with the switching of the LED light bar which, with its three different colors, green, yellow and red, will indicate the good or bad functioning of the tested component.

- **Battery test**
- **Cranking test**
- **Alternator test**

		XD4	XD8	XD16	XD24	XD32
Technology	Electronic					
Input voltage (Autosetting)	1 ~ 220-240V 50/60 Hz					
Absorbed power	78W	150W	350W	480W	600W	
Battery charger						
Battery voltage	6 / 12V	12 / 24V	12 / 24V	12 / 24V	12V	
Battery capacity: Min - Max	4 - 90Ah	4 - 180Ah	8 - 340Ah	8 - 500Ah	8 - 680Ah	
Maintenance	130Ah	260Ah	500Ah	750Ah	1000Ah	
Compatible batteries	Automotive Pb: WET, MF, EFB, AGM, GEL, Ca/Ca, Start&Stop / Lithium: LiFePO4					
Average charging current	6V	1 - 2 - 4A	-	-	-	-
	12V	1 - 2 - 4A	2 - 4 - 8A	2 - 4 - 8 - 16A	2 - 8 - 12 - 24A	2 - 8 - 16 - 32A
	24V	-	1 - 2 - 4A	2 - 4 - 8A	2 - 8 - 12A	-
Program selection	WET, EFB, AGM, Winter, GEL Li: Lithium: LiFePO4			WET, EFB, AGM, AGM Power, GEL Li: Lithium: LiFePO4		
Charging voltages	6V	7,1 - 7,2 - 7,25 - 7,35 - 7,4V	-	-	-	-
	12V	14,2 - 14,4 - 14,5 - 14,7 - 14,8V	14,2 - 14,4 - 14,5 - 14,7 - 15V			
	24V	-	28,4 - 28,8 - 29,0 - 29,4 - 29,6V			-
Recovery	(6V) 7,45V (12V) 14,9V	(12V) 14,9V (24V) 29,8V	(12V) 14,9V (24V) 29,8V	(12V) 14,9V (24V) 29,8V	(12V) 14,9V	
Charge steps	9	9	9	9	9	
Charge shut-off	U (Floating) + UaUe (Pulse)					
Regulated power supply						
Battery support	-	-	14V - 13A Max	14V - 21A Max	14V - 30A Max	
Battery change supply	14V	14V	14V	14V	14V	
Showroom supply	13,8V	13,8V	13,8V	13,8V	13,8V	
Test: battery / cranking / alternator	Systems: 12V	Systems: 12V / 24V	Systems: 12V / 24V	Systems: 12V / 24V	Systems: 12V	
Voltmeter	•	•	•	•	•	
Cable length	2,2 m	2,2 m	2,2 m	2,2 m	2,2 m	
IP Rating	IP65	IP65	IP20	IP20	IP20	
Dimensions	185 x 120 x 58	220 x 140 x 67	290 x 154 x 84	290 x 154 x 84	290 x 154 x 84	
Weight	0,7 kg	1 kg	2 kg	2,3 kg	2,3 kg	
Code	320400	320800	321600	322400	323200	

ACCESSORIES								
	Adapter for motorcycle battery d.6mm with fuse	Adapter for motorcycle battery d.6mm with fuse and charge indicator	Cable with car lighter plug	Extension cable 3mt	Adapter for motorcycle battery d.6mm	Extension cable 3mt	Adapter for motorcycle battery d.6mm	Extension cable 3mt
XD4	●	○	○	○				
XD8	●	○	○	○				
XD16					●	○		
XD24							○	○
XD32							○	○
Code	011278	011279	011280	011281	011282	011283	011284	011285

- Included accessories
- Optional accessories



DECA S.p.A.

Strada dei Censiti, 10
Zona Industriale Rovereta
47891 Falciano - Repubblica di San Marino

Tel. da/from Italy 0549 910711
from other Countries +378 0549 910711

Fax da/from Italy 0549 908360
from other Countries +378 0549 908360

www.decaweld.com

Document not contractual. Deca S.p.A. reserves the right to modify the specifications of the product without prior notice.

AA0180-00

Distributed by