

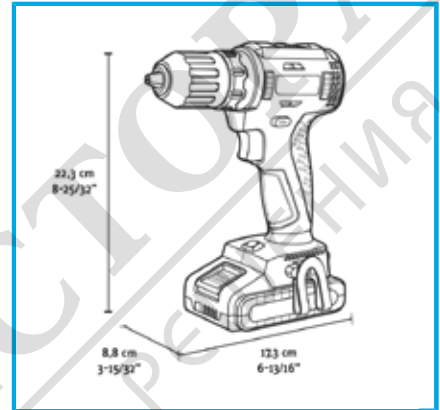







ART. FB20CD3AB-B
CORDLESS DRILL - SCREWDRIVER 20V



BRUSHLESS MOTOR, AUTOMATIC SPINDLE LOCK, KEYLESS SELF-TIGHTENING CHUCK, 21 CLUTCH SETTINGS, STEP SPEED SELECTION, ELECTRONIC...



| | |
|-------------------------------|----------------------------|
| No-load speed | 0-420 min-1 / 0-1400 min-1 |
| Chuck tightening range | 2 - 13 mm |
| Torque | 35 / 55 Nm |
| Drilling output steel | Max 13 mm |
| Drilling output wood | Max 40 mm |
| Max screw diameter | 8 mm |
| EAN Code | 8012667404277 |
| Packaging dimensions | 365 x 320 x 100 h mm |
| Gross weight | 2,26 kg |

-  Carrying case
-  Brushless Motor
-  Electronic Speed
-  2 Functions
-  Variable Torque
-  Speed Selector
-  2 Functions
- Non incluso
- Non incluso

