

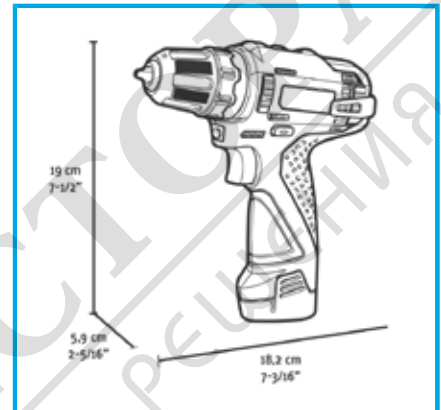







ART. FB12CD3AS-22B
CORDLESS DRILL - SCREWDRIVER 12V



AUTOMATIC SPINDLE LOCK, KEYLESS SELF-TIGHTENING CHUCK, 21 CLUTCH SETTINGS, STEP SPEED SELECTION, ELECTRONIC SPEED ADJUSTMENT,...



No-load speed	0-380 min-1 / 0-1250 min-1
Chuck tightening range	0,8 - 10 mm
Torque	19 / 30 Nm
Drilling output steel	Max 10 mm
Drilling output wood	Max 28 mm
Max screw diameter	6 mm
EAN Code	8012667404246
Gross weight	2,29 kg
Packaging dimensions	320 x 225 x 90 h mm

-  Carrying case
-  Brushless Motor
-  Electronic Speed
-  Keyless
-  Variable Torque
-  Speed Selector
-  2 Functions
- 2 x 2 Ah, 12 V
- 2 A, 12 V

