

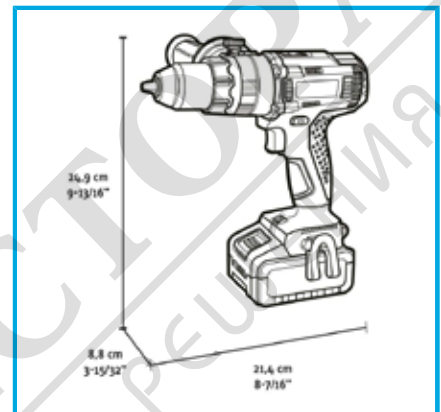







ART. FB20ID3AB-B
IMPACT DRILL / SCREWDRIVER 20 V



BRUSHLESS MOTOR, AUTOMATIC SPINDLE LOCK, METAL KEYLESS
 SELF-TIGHTENING CHUCK, 1 CLUTCH SETTINGS, STEP SPEED
 SELECTION, LECTRONIC..



| | |
|---------------------------------|------------------------------|
| No-load speed | 0-550 min-1 / 0-2000 min-1 |
| Impact rate | 0-7500 min-1 / 0-30000 min-1 |
| Chuck tightening range | 1,5 - 13 mm |
| Torque | 70 / 75 Nm |
| Drilling output concrete | Max 16 mm |
| Drilling output steel | Max 13 mm |
| Drilling output wood | Max 40 mm |
| Max screw diameter | 10 mm |
| EAN Code | 8012667404307 |
| Packaging dimensions | 405 x 330 x 105 h mm |
| Gross weight | 3,25 kg |

-  Carrying case
-  Keyless
-  Electronic Speed
-  3 Functions
-  Brushless Motor
-  Speed Selector
-  Variable Torque
- Non inclusio
- Non inclusio

