

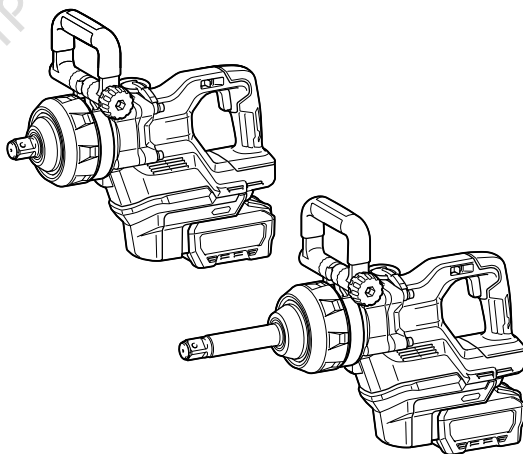

EN	Cordless Impact Wrench	INSTRUCTION MANUAL	5
FR	Boulonneuse sans Fil	MANUEL D'INSTRUCTIONS	14
DE	Akku - Schlagschrauber	BETRIEBSANLEITUNG	24
IT	Avvitatrice ad impulso a batteria	ISTRUZIONI PER L'USO	35
NL	Accuslagmoersleutel	GEbruIKSAANWIJZING	45
ES	Llave de Impacto Inalámbrica	MANUAL DE INSTRUCCIONES	55
PT	Chave de Impacto a Bateria	MANUAL DE INSTRUÇÕES	64
EL	Κρουστικό κλειδί μπαταρίας	ΕΓΧΕΙΡΙΔΙΟ ΟΔΗΓΙΩΝ	73
TR	Akülü Darbeli Somun Sıkma	KULLANMA KILAVUZU	83

TW009G
TW010G

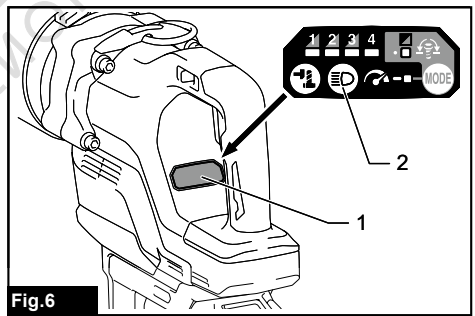

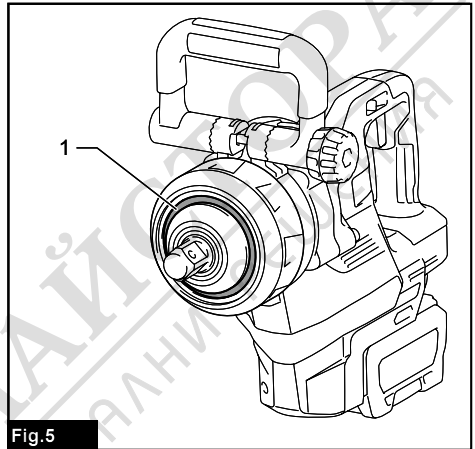
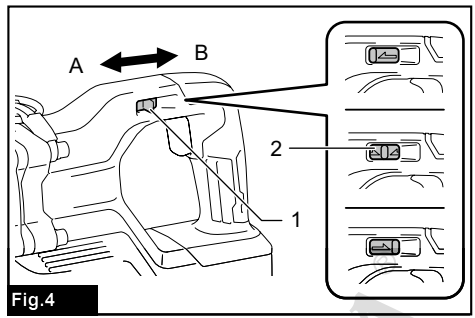
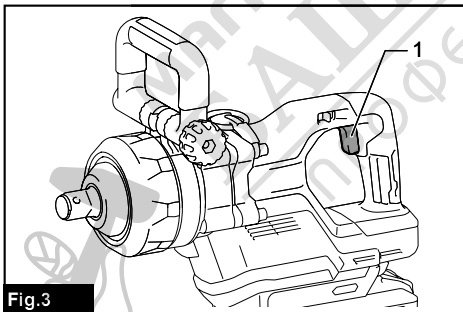
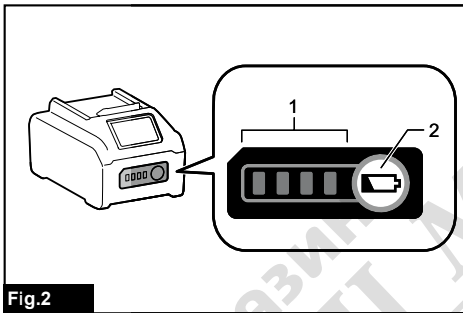
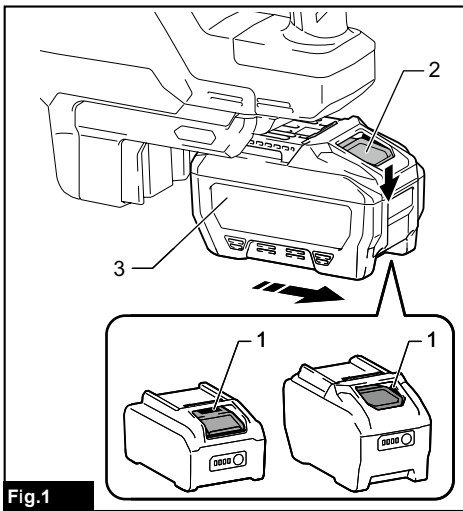

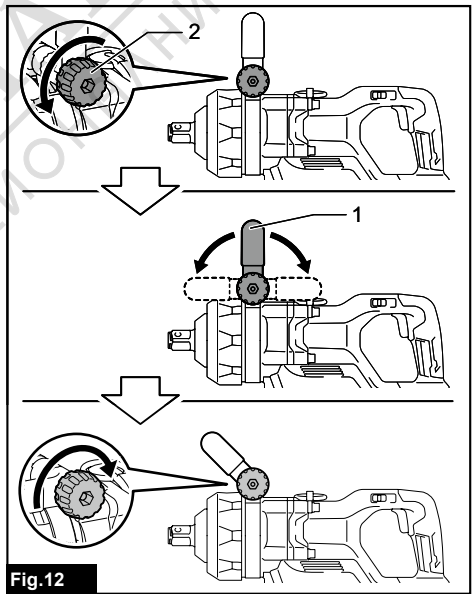
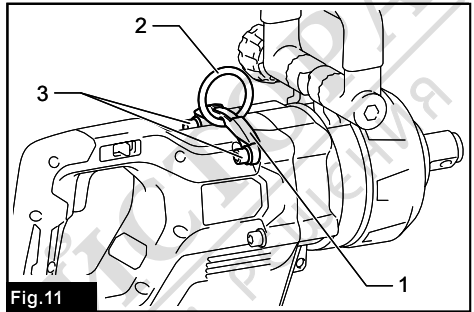
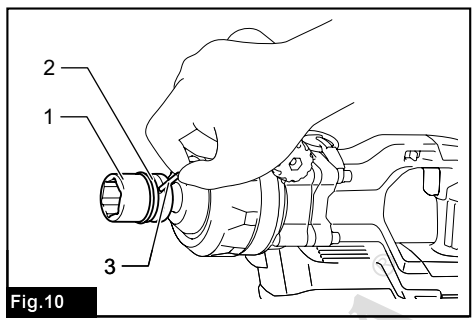
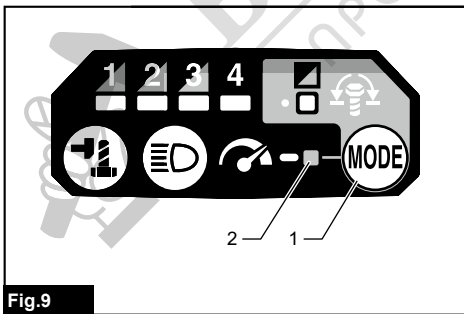
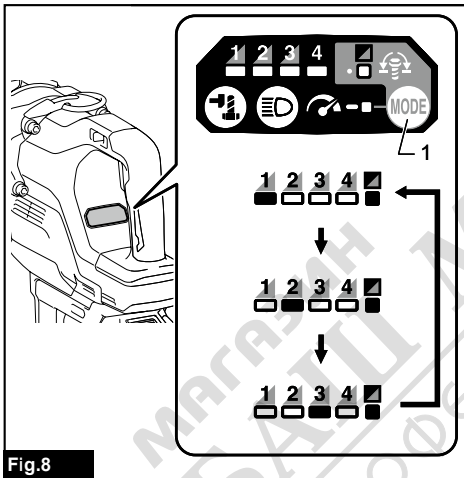
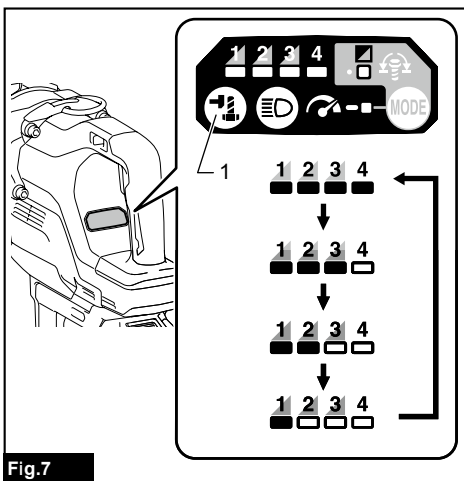

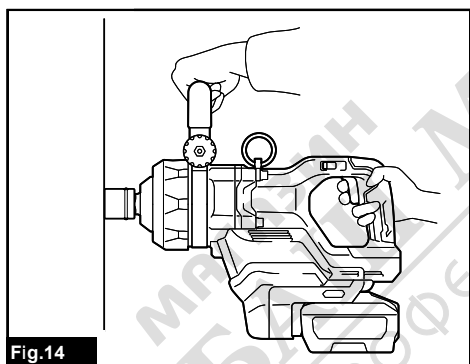
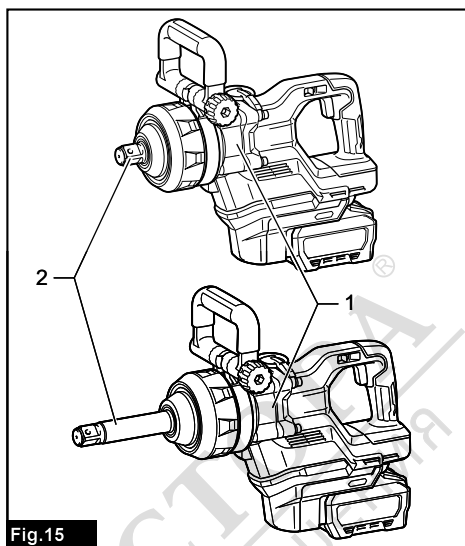
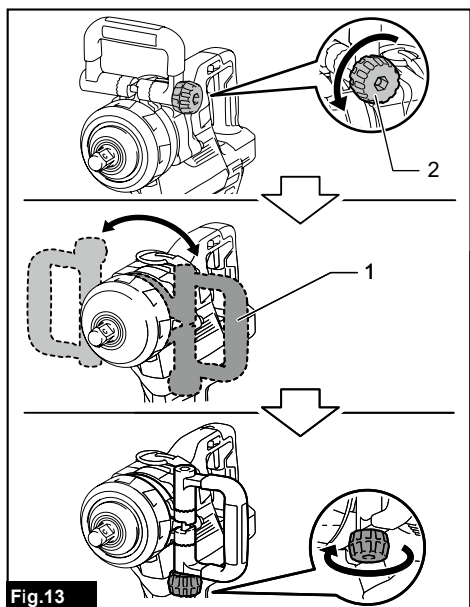

SPECIFICATIONS

Model:		TW009G	TW010G
Fastening capacities	Standard bolt	M27 - M45	
	High tensile bolt	M20 - M33	
Square drive		25.4 mm	
No load speed (RPM)	Max impact mode (4)	0 - 1,200 min ⁻¹	
	Hard impact mode (3)	0 - 850 min ⁻¹	
	Medium impact mode (2)	0 - 700 min ⁻¹	
	Soft impact mode (1)	0 - 600 min ⁻¹	
Impacts per minute	Max impact mode (4)	0 - 1,750 min ⁻¹	
	Hard impact mode (3)	0 - 1,500 min ⁻¹	
	Medium impact mode (2)	0 - 1,300 min ⁻¹	
	Soft impact mode (1)	0 - 1,200 min ⁻¹	
Max. fastening torque (at max impact mode (4))	Fastening with M36 for 6 seconds	3,150 N·m	
	Fastening with M36 for 3 seconds	2,850 N·m	
Nut-Busting torque (at max impact mode (4))		4,000 N·m	
Overall length		435 mm	570 mm
Rated voltage		D.C. 36 V - 40 V max	
Net weight		11.0 - 11.9 kg	12.0 - 12.9 kg

- Due to our continuing program of research and development, the specifications herein are subject to change without notice.
- Specifications may differ from country to country.
- The weight may differ depending on the attachment(s), including the battery cartridge. The lightest and heaviest combination are shown in the table.

Applicable battery cartridge and charger

Battery cartridge	BL4040 / BL4040F* / BL4050F* / BL4080F* * : Recommended battery
Charger	DC40RA / DC40RB / DC40RC / DC40WA / BCC01 / BCC02

- Some of the battery cartridges and chargers listed above may not be available depending on your region of residence.

⚠WARNING: Only use the battery cartridges and chargers listed above. Use of any other battery cartridges and chargers may cause injury and/or fire.

Intended use

The tool is intended for fastening bolts and nuts.

Noise

The typical A-weighted noise level determined according to EN62841-2-2:

Model TW009G

Sound pressure level (L_{pA}) : 101 dB (A)

Sound power level (L_{WA}) : 109 dB (A)

Uncertainty (K) : 3 dB (A)

Model TW010G

Sound pressure level (L_{pA}) : 103 dB(A)

Sound power level (L_{WA}) : 111 dB (A)

Uncertainty (K) : 3 dB(A)

NOTE: The declared noise emission value(s) has been measured in accordance with a standard test method and may be used for comparing one tool with another.

NOTE: The declared noise emission value(s) may also be used in a preliminary assessment of exposure.

⚠WARNING: Wear ear protection.

⚠WARNING: The noise emission during actual use of the power tool can differ from the declared value(s) depending on the ways in which the tool is used especially what kind of workpiece is processed.

⚠WARNING: Be sure to identify safety measures to protect the operator that are based on an estimation of exposure in the actual conditions of use (taking account of all parts of the operating cycle such as the times when the tool is switched off and when it is running idle in addition to the trigger time).

Vibration

The vibration total value (tri-axial vector sum) determined according to EN62841-2-2:

Model TW009G

Work mode: impact tightening of fasteners of the maximum capacity of the tool

Vibration emission (a_h) : 37.5 m/s²

Uncertainty (K) : 1.6 m/s²

Model TW010G

Work mode: impact tightening of fasteners of the maximum capacity of the tool

Vibration emission (a_h) : 33.4 m/s²

Uncertainty (K) : 1.6 m/s²

NOTE: The declared vibration total value(s) has been measured in accordance with a standard test method and may be used for comparing one tool with another.

NOTE: The declared vibration total value(s) may also be used in a preliminary assessment of exposure.

⚠WARNING: The vibration emission during actual use of the power tool can differ from the declared value(s) depending on the ways in which the tool is used especially what kind of workpiece is processed.

⚠WARNING: Be sure to identify safety measures to protect the operator that are based on an estimation of exposure in the actual conditions of use (taking account of all parts of the operating cycle such as the times when the tool is switched off and when it is running idle in addition to the trigger time).

Declarations of Conformity

For European countries only

The Declarations of conformity are included in Annex A to this instruction manual.

SAFETY WARNINGS

General power tool safety warnings

⚠WARNING Read all safety warnings, instructions, illustrations and specifications provided with

this power tool. Failure to follow all instructions listed below may result in electric shock, fire and/or serious injury.

Save all warnings and instructions for future reference.

The term "power tool" in the warnings refers to your mains-operated (corded) power tool or battery-operated (cordless) power tool.

Cordless impact wrench safety warnings

1. **Hold the power tool by insulated gripping surfaces, when performing an operation where the fastener may contact hidden wiring.** Fasteners contacting a "live" wire may make exposed metal parts of the power tool "live" and could give the operator an electric shock.
2. **Wear ear protectors.**
3. **Check the impact socket carefully for wear, cracks or damage before installation.**
4. **Hold the tool firmly.**
5. **Keep hands away from rotating parts.**
6. **Do not touch the impact socket, bolt, nut or the workpiece immediately after operation.** They may be extremely hot and could burn your skin.
7. **Always be sure you have a firm footing. Be sure no one is below when using the tool in high locations.**
8. **The proper fastening torque may differ depending upon the kind or size of the bolt. Check the torque with a torque wrench.**
9. **Make sure there are no electrical cables, water pipes, gas pipes etc. that could cause a hazard if damaged by use of the tool.**

SAVE THESE INSTRUCTIONS.

⚠WARNING: DO NOT let comfort or familiarity with product (gained from repeated use) replace strict adherence to safety rules for the subject product.

MISUSE or failure to follow the safety rules stated in this instruction manual may cause serious personal injury.

Important safety instructions for battery cartridge

1. **Before using battery cartridge, read all instructions and cautionary markings on (1) battery charger, (2) battery, and (3) product using battery.**
2. **Do not disassemble or tamper with the battery cartridge.** It may result in a fire, excessive heat, or explosion.
3. **If operating time has become excessively shorter, stop operating immediately.** It may result in a risk of overheating, possible burns and even an explosion.
4. **If electrolyte gets into your eyes, rinse them out with clear water and seek medical attention right away.** It may result in loss of your

eyesight.

5. **Do not short the battery cartridge:**
 - (1) **Do not touch the terminals with any conductive material.**
 - (2) **Avoid storing battery cartridge in a container with other metal objects such as nails, coins, etc.**
 - (3) **Do not expose battery cartridge to water or rain.**

A battery short can cause a large current flow, overheating, possible burns and even a breakdown.
6. **Do not store and use the tool and battery cartridge in locations where the temperature may reach or exceed 50 °C (122 °F).**
7. **Do not incinerate the battery cartridge even if it is severely damaged or is completely worn out. The battery cartridge can explode in a fire.**
8. **Do not nail, cut, crush, throw, drop the battery cartridge, or hit against a hard object to the battery cartridge.** Such conduct may result in a fire, excessive heat, or explosion.
9. **Do not use a damaged battery.**
10. **The contained lithium-ion batteries are subject to the Dangerous Goods Legislation requirements.**

For commercial transports e.g. by third parties, forwarding agents, special requirement on packaging and labeling must be observed.
For preparation of the item being shipped, consulting an expert for hazardous material is required.
Please also observe possibly more detailed national regulations.
Tape or mask off open contacts and pack up the battery in such a manner that it cannot move around in the packaging.
11. **When disposing the battery cartridge, remove it from the tool and dispose of it in a safe place. Follow your local regulations relating to disposal of battery.**
12. **Use the batteries only with the products specified by Makita.** Installing the batteries to non-compliant products may result in a fire, excessive heat, explosion, or leak of electrolyte.
13. **If the tool is not used for a long period of time, the battery must be removed from the tool.**
14. **During and after use, the battery cartridge may take on heat which can cause burns or low temperature burns. Pay attention to the handling of hot battery cartridges.**
15. **Do not touch the terminal of the tool immediately after use as it may get hot enough to cause burns.**
16. **Do not allow chips, dust, or soil stuck into the terminals, holes, and grooves of the battery cartridge.** It may cause heating, catching fire, burst and malfunction of the tool or battery cartridge, resulting in burns or personal injury.
17. **Unless the tool supports the use near high-voltage electrical power lines, do not use the battery cartridge near high-voltage electrical power lines.** It may result in a malfunction or breakdown of the tool or battery cartridge.
18. **Keep the battery away from children.**

SAVE THESE INSTRUCTIONS.

CAUTION: Only use genuine Makita batteries. Use of non-genuine Makita batteries, or batteries that have been altered, may result in the battery bursting causing fires, personal injury and damage. It will also void the Makita warranty for the Makita tool and charger.

Tips for maintaining maximum battery life

1. **Charge the battery cartridge before completely discharged. Always stop tool operation and charge the battery cartridge when you notice less tool power.**
2. **Never recharge a fully charged battery cartridge. Overcharging shortens the battery service life.**
3. **Charge the battery cartridge with room temperature at 10 °C - 40 °C (50 °F - 104 °F). Let a hot battery cartridge cool down before charging it.**
4. **When not using the battery cartridge, remove it from the tool or the charger.**
5. **Charge the battery cartridge if you do not use it for a long period (more than six months).**

FUNCTIONAL DESCRIPTION

CAUTION: Always be sure that the tool is switched off and the battery cartridge is removed before adjusting or checking function on the tool.

Installing or removing battery cartridge

CAUTION: Always switch off the tool before installing or removing of the battery cartridge.

CAUTION: Hold the tool and the battery cartridge firmly when installing or removing battery cartridge. Failure to hold the tool and the battery cartridge firmly may cause them to slip off your hands and result in damage to the tool and battery cartridge and a personal injury.

To install the battery cartridge, align the tongue on the battery cartridge with the groove in the housing and slip it into place. Insert it all the way until it locks in place with a little click. If you can see the red indicator as shown in the figure, it is not locked completely.

To remove the battery cartridge, slide it from the tool while sliding the button on the front of the cartridge.

► **Fig.1:** 1. Red indicator 2. Button 3. Battery cartridge

CAUTION: Always install the battery cartridge fully until the red indicator cannot be seen. If not, it may accidentally fall out of the tool, causing injury to you or someone around you.

CAUTION: Do not install the battery cartridge forcibly. If the cartridge does not slide in easily, it is not being inserted correctly.

Tool / battery protection system

The tool is equipped with a tool/battery protection system. This system automatically cuts off the power to extend tool and battery life. The tool will automatically stop during operation if the tool or battery is placed under one of the following conditions:

Overload protection

This protection works when the tool is operated in a manner that causes it to draw an abnormally high current. In this situation, turn the tool off and stop the application that caused the tool to become overloaded. Then turn the tool on to restart.

Overheat protection

When the tool is overheated, the tool stops automatically and the lamps blink. In this situation, let the tool and battery cool before turning the tool on again.

Overdischarge protection

This protection works when the remaining battery capacity gets low. In this situation, remove the battery from the tool and charge the battery.

Protections against other causes

Protection system is also designed for other causes that could damage the tool and allows the tool to stop automatically. Take all the following steps to clear the causes, when the tool has been brought to a temporary halt or stop in operation.





1. Make sure that all switch(es) is/are in the off position, and then turn the tool on again to restart.
2. Charge the battery(ies) or replace it/them with recharged battery(ies).
3. Let the tool and battery(ies) cool down.



















If no improvement can be found by restoring protection system, then contact your local Makita Service Center.

Indicating the remaining battery capacity

Press the check button on the battery cartridge to indicate the remaining battery capacity. The indicator lamps light up for a few seconds.

► Fig.2: 1. Indicator lamps 2. Check button

Indicator lamps			Remaining capacity
Lighted	Off	Blinking	
			75% to 100%
			

Indicator lamps			Remaining capacity
Lighted	Off	Blinking	
			50% to 75%
			
			25% to 50%
			0% to 25%
			Charge the battery.
			The battery may have malfunctioned.
			

NOTE: Depending on the conditions of use and the ambient temperature, the indication may differ slightly from the actual capacity.

NOTE: The first (far left) indicator lamp will blink when the battery protection system works.

Switch action

CAUTION: Before installing the battery cartridge into the tool, always check to see that the switch trigger actuates properly and returns to the "OFF" position when released.

To start the tool, simply pull the switch trigger. Tool speed is increased by increasing pressure on the switch trigger. Release the switch trigger to stop.

► Fig.3: 1. Switch trigger

NOTE: When full speed mode is turned on, the rotation speed becomes fastest even if you do not pull the switch trigger fully.

For detail information, refer to the section of full speed mode.

Reversing switch action

CAUTION: Always check the direction of rotation before operation.

CAUTION: Use the reversing switch only after the tool comes to a complete stop. Changing the direction of rotation before the tool stops may damage the tool.

CAUTION: When not operating the tool, always set the reversing switch lever to the neutral position.

This tool has a reversing switch lever to change the direction of rotation. Move the reversing switch lever to side A for clockwise rotation or to side B for counter-clockwise rotation. When the reversing switch lever is in the neutral position, the switch trigger can be pulled but the motor of the tool does not rotate.

► Fig.4: 1. Reversing switch lever 2. Neutral position



Lighting up the front lamp

CAUTION: Do not look in the light or see the source of light directly.

When the reversing switch lever is on the side A or side B and the switch trigger is pulled, the front lamp turns on. To turn off, release the switch trigger. The front lamp goes out approximately 10 seconds after releasing the switch trigger.

► Fig.5: 1. Front lamp

Changing brightness

To change the brightness, press the button . The brightness has three levels. Every time you press the button , the brightness decreases and finally goes out. When the lamp status is off, the front lamp will not turn on even if the switch trigger is pulled. To turn on the lamp status again, press the button . The brightness will return to the highest.

► Fig.6: 1. Switch panel 2. Button 

NOTE: To confirm the lamp status, pull the switch trigger. When the front lamp lights up by pulling the switch trigger, the lamp status is ON. When the front lamp does not light up, the lamp status is OFF.

NOTE: When the tool is overheated, the front lamp flashes for one minute, and then the lamps on the switch panel go off. In this case, cool down the tool before operating again.

NOTE: Use a dry cloth to wipe the dirt off the lens of the front lamp. Be careful not to scratch the lens of the front lamp, or it may lower the illumination.

NOTE: While pulling the switch trigger, the lamp status cannot be changed.

NOTE: For approximately 10 seconds after releasing the switch trigger, the lamp status can be changed.

Light mode



You can use the tool as a light.

To turn on the light, set the reversing switch lever in the neutral position and pull the switch trigger.

The front lamp keeps lighting up for approximately one hour.

To turn off the light, pull the switch trigger again.

Changing brightness

To change the brightness, press the button . The brightness has three levels. Every time you press the button , the brightness decreases. The brightness will return to the highest when operating in the lowest brightness.

NOTE: You cannot change the application mode while the light mode is on. The lamps on the switch panel do not light up when the light mode is on.

NOTE: You cannot turn on/off the lamp status when the light mode is on.

NOTE: The light mode does not work when the tool/battery protection system activates or the battery capacity is not enough.

Changing the application mode



Changing the impact force

You can change the impact force in four steps: 4 (max), 3 (hard), 2 (medium), and 1 (soft).

This allows a tightening suitable to the work.



The level of the impact force changes every time you press the button .

You can change the impact force within approximately one minute after releasing the switch trigger.

NOTE: You can extend the time to change the impact force approximately one minute if you press the button  or .

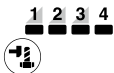
► Fig.7: 1. Button 

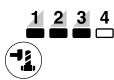
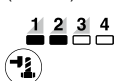
Application mode (Impact force grade displayed on panel)	Maximum blows		Purpose
	TW009G	TW010G	
4 (Max) 	1,750 min ⁻¹ (/min)		Tightening with the maximum force and speed. Tightening when the force and the speed are desired.

Application mode (Impact force grade displayed on panel)	Maximum blows		Purpose
	TW009G	TW010G	
3 (Hard) 	1,500 min ⁻¹ (/min)		Tightening with less force and speed than Max mode (easier to control than Max mode). Tightening when the force and the speed are desired.
2 (Medium) 	1,300 min ⁻¹ (/min)		Tightening when a good finishing is needed. Tightening when you need good control power.
1 (Soft) 	1,200 min ⁻¹ (/min)		Tightening with less force to avoid screw thread breakage. Tightening when you need fine adjustment with small diameter bolts.

: The lamp is on.

NOTE: When none of the lamps on the switch panel is lit, pull the switch trigger once before pressing the button .

NOTE: All lamps on the switch panel go out when the tool is turned off to save the battery power. The impact force grade can be checked by pulling the switch trigger to the extent that the tool does not operate.

Changing the application mode



This tool employs several easy-to-use application modes for driving bolts with good control.

The type of the application mode changes every time you press the button .

You can change the application mode within approximately one minute after releasing the switch trigger.

NOTE: You can extend the time to change the application mode approximately one minute if you press the button  or .

► **Fig.8:** 1. Button 

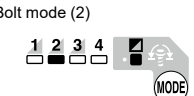
Application mode (Assist type displayed on panel)	Feature	Purpose
Bolt mode 	Clockwise This mode helps to repeat screwdriving continuously with equal torque. This mode also helps to reduce the risk of breakage of bolts/nuts due to overtightening. Counterclockwise This mode helps to prevent a bolt from falling off. When loosening a bolt with the tool driving in counterclockwise rotation, the tool automatically stops or slows down after the bolt/nut gets enough loosened. NOTE: The timing to stop the driving varies depending on the type of the bolt/nut and material to be driven. Make a test driving before using this mode.	Clockwise Preventing overtightening of bolts. Counterclockwise Loosening bolts.
Bolt mode (1) 	Clockwise The impact force is 2. The tool stops automatically as soon as it has started impact blows. Counterclockwise The impact force is 4. The tool stops automatically as soon as it has stopped impact blows.	—
Bolt mode (2) 	Clockwise The impact force is 3. The tool stops automatically approximately 0.5 second later from the moment that the tool has started impact blows. Counterclockwise The impact force is 4. The tool stops automatically approximately 0.2 second later from the moment that the tool has stopped impact blows.	—

Application mode (Assist type displayed on panel)	Feature	Purpose
Bolt mode (3) 	Clockwise The impact force is 4. The tool stops automatically approximately 1 second later from the moment that the tool has started impact blows. Counterclockwise The impact force is 4. The tool slows down the rotation after it has stopped impact blows.	—



: The lamp is on.

NOTE: When none of the lamps on the switch panel is lit, pull the switch trigger once before pressing the button .

NOTE: All lamps on the switch panel go out when the tool is turned off to save the battery power. The type of the application mode can be checked by pulling the switch trigger to the extent that the tool does not operate.

Full speed mode

When full speed mode is turned on, the tool speed becomes fastest even if you do not pull the switch trigger fully. When full speed mode is turned off, the tool speed increases as you increase the pressure on the switch trigger.

To turn on full speed mode, press and hold the button . To turn off full speed mode, press and hold the button  again.

The lamp turns on while full speed mode is on.

► **Fig.9:** 1. Button  2. Lamp

NOTE: Full speed mode continues even after switching the impact force mode/application mode.

Electric brake

This tool is equipped with an electric brake. If the tool consistently fails to quickly stop after the switch trigger is released, have the tool serviced at a Makita service center.

Accidental re-start preventive function

Even if you install the battery cartridge while pulling the switch trigger, the tool does not start.

To start the tool, first release the switch trigger and then pull the switch trigger.

ASSEMBLY

CAUTION: Always be sure that the tool is switched off and the battery cartridge is removed before carrying out any work on the tool.

Selecting correct impact socket

Always use the correct size impact socket for bolts and nuts. An incorrect size impact socket will result in inaccurate and inconsistent fastening torque and/or damage to the bolt or nut.

Installing or removing impact socket

CAUTION: Make sure that the impact socket and the mounting portion are not damaged before installing the impact socket.

CAUTION: After inserting the impact socket, make sure that it is firmly secured. If it comes out, do not use it.

Move the O-ring out of the groove in the impact socket and remove the pin from the impact socket. Fit the impact socket onto the square drive so that the hole in the impact socket is aligned with the hole in the square drive.

Insert the pin through the hole in the impact socket and square drive. Then return the O-ring to the original position in the impact socket groove to retain the pin.

To remove the impact socket, follow the installation procedures in reverse.

► **Fig.10:** 1. Impact socket 2. O-ring 3. Pin

Ring

CAUTION: Before using the ring, always make sure that the bracket and ring are secured and not damaged.

CAUTION: Use the hanging/mounting parts for their intended purposes only. Using for unintended purpose may cause accident or personal injury.

The ring is convenient for hanging the tool with hoist. First, place the rope through the ring. Then hang the tool up to the air with hoist.

If you want to remove the ring, ask your local Makita Service Center.

► **Fig.11:** 1. Bracket 2. Ring 3. Screws

OPERATION

CAUTION: When using the tool in high places, make sure that no one is below you. Dropping your tool from a height may cause serious injuries.

CAUTION: If the tool malfunctions or makes abnormal noises, stop using the tool. then contact your local Makita Service Center.

Angle and position adjustment of the side handle

CAUTION: Always use the side handle to ensure safe operation.

CAUTION: After installing or adjusting the side handle, make sure that the side handle is firmly secured.

The angle of the side handle can be adjusted at 9 steps back and forth in a horizontal direction. The position of the side handle can also be adjusted 360° every 45° around the circumference of the hammer case.

Angle adjustment of the side handle

1. Loosen the clamp nut.
2. Adjust the angle of the side handle back and forth to the desired angle as shown in the figure.
3. Tighten the clamp nut firmly.

► Fig.12: 1. Side handle 2. Clamp nut

Position adjustment of the side handle

1. Loosen the clamp nut.
2. Adjust the position of the side handle to the desired position by rotating the side handle to the left or right as shown in the figure.
3. Tighten the clamp nut firmly.

► Fig.13: 1. Side handle 2. Clamp nut

Tightening bolt

CAUTION: Hold the tool securely to prevent your body from being swung around by the tool when using the tool.

CAUTION: Always insert the battery cartridge all the way until it locks in place. If you can see the red indicator, it is not locked completely. Insert it fully until the red indicator cannot be seen. If not, it may accidentally fall out of the tool, causing injury to you or someone around you.

Hold the tool firmly and place the impact socket over the bolt or nut. Turn the tool on and fasten for the proper fastening time.

► Fig.14

The proper fastening torque may differ depending upon the kind or size of the bolt, the material of the workpiece to be fastened, etc. The relation between fastening

torque and fastening time is shown in the figures.

Proper fastening torque for high tensile bolt with max impact mode (4)

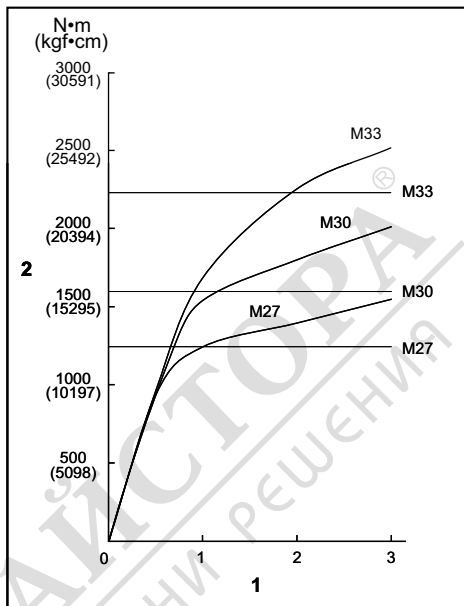

1. Fastening time (second) 2. Fastening torque

NOTE: Hold the tool pointed straight at the bolt or nut.

NOTE: Excessive fastening torque may damage the bolt/nut or impact socket. Before starting your job, always perform a test operation to determine the proper fastening time for your bolt or nut.

NOTE: If the tool is operated continuously until the battery cartridge has discharged, allow the tool to rest for 15 minutes before proceeding with a fresh battery cartridge.

The fastening torque is affected by a wide variety of factors including the following. After fastening, always check the torque with a torque wrench.

1. When the battery cartridge is discharged almost completely, voltage will drop and the fastening torque will be reduced.
2. Impact socket
 - Failure to use the correct size impact socket will cause a reduction in the fastening torque.
 - A worn impact socket (wear on the hex end or square end) will cause a reduction in the fastening torque.
3. Bolt
 - Even though the torque coefficient and the class of bolt are the same, the proper fastening torque will differ according to the diameter of bolt.
 - Even though the diameters of bolts are the same, the proper fastening torque will differ according to the torque coefficient, the class of bolt and the bolt length.
4. The use of the extension bar somewhat reduces

the fastening force of the impact wrench.
Compensate by fastening for a longer period of time.

5. The manner of holding the tool or the material of driving position to be fastened will affect the torque.
6. Operating the tool at low speed will cause a reduction in the fastening torque.

⚠CAUTION: If the tool is operated continuously, do not touch the hammer case and square drive. The hammer case and square drive may be extremely hot and could burn your skin.

► Fig.15: 1. Hammer case 2. Square drive

MAINTENANCE

⚠CAUTION: Always be sure that the tool is switched off and the battery cartridge is removed before attempting to perform inspection or maintenance.

NOTICE: Never use gasoline, benzine, thinner, alcohol or the like. Discoloration, deformation or cracks may result.

To maintain product SAFETY and RELIABILITY, repairs, any other maintenance or adjustment should be performed by Makita Authorized or Factory Service Centers, always using Makita replacement parts.

OPTIONAL ACCESSORIES

⚠CAUTION: These accessories or attachments are recommended for use with your Makita tool specified in this manual. The use of any other accessories or attachments might present a risk of injury to persons. Only use accessory or attachment for its stated purpose.

If you need any assistance for more details regarding these accessories, ask your local Makita Service Center.

- Impact socket
- Extension bar
- Makita genuine battery and charger

NOTE: Some items in the list may be included in the tool package as standard accessories. They may differ from country to country.