

# metabo®

PROFESSIONAL POWER TOOL SOLUTIONS

**RWE 1200**  
**RWEV 1200-2**  
**RWEV 1600-2**

**RW 18 LTX BL 120**  
**RW 18 LTX BL 140-2**



**de** Originalbetriebsanleitung 4  
**en** Original instructions 9  
**fr** Notice originale 13  
**nl** Oorspronkelijke gebruiksaanwijzing 18  
**it** Istruzioni originali 23  
**es** Manual original 28  
**pt** Manual de instruções original 33  
**sv** Bruksanvisning i original 38

**fi** Alkuperäiset ohjeet 42  
**no** Original bruksanvisning 46  
**da** Original brugsanvisning 50  
**pl** Instrukcja oryginalna 54  
**el** Πρωτότυπο οδηγιών χρήσης 59  
**hu** Eredeti használati utasítás 64  
**uk** Оригінальна інструкція з експлуатації 69

# RWE...

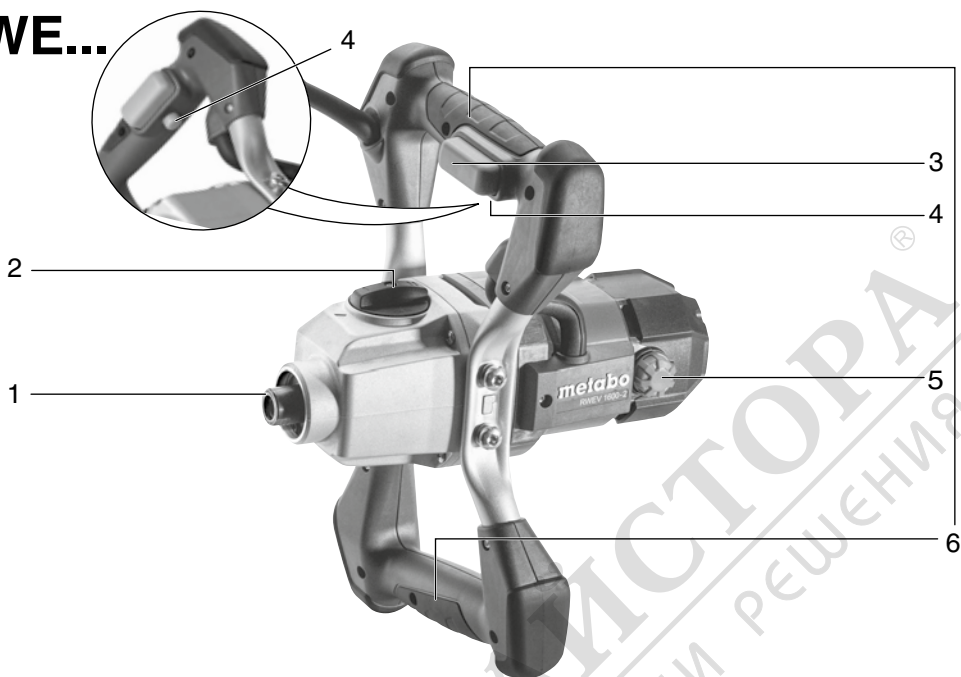

# RW 18...

RW 18 LTX...

Beep

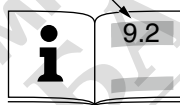

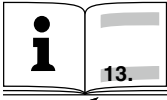
		<b>RWE 1200</b> *1) Serial Number 14048...	<b>RWEV 1200-2</b> *1) Serial Number 14049...	<b>RWEV 1600-2</b> *1) Serial Number 14050...	<b>RW 18 LTX BL 120</b> *1) Serial Number 01164...	<b>RW 18 LTX BL 140-2</b> *1) Serial Number 01165...
		<b>P<sub>1</sub></b>	W	1200	1200	1600
<b>P<sub>2</sub></b>	W	580	580	660	-	-
<b>U</b>	V	-	-	-	18	18
<b>n<sub>0</sub></b>	min <sup>-1</sup> (rpm)	0-900	0-300 0-650		0-820	0-280 0-610
<b>n<sub>1</sub></b>	min <sup>-1</sup> (rpm)	700	300 650		810	610
<b>G</b>	-	M14				
<b>D<sub>R</sub></b>	mm (in)	120 (4 23/32)	140 (5 1/2)	160 (6 5/16)	120 (4 23/32)	140 (5 1/2)
<b>D</b>	mm (in)	50 (1 31/32")				
<b>m</b>	kg (lbs)	3,4 (7.5)	4,3 (9.5)	4,5 (9.9)	4,0 (8.8)	4,8 (10.6)
<b>a<sub>h,D</sub>/K<sub>h,D</sub></b>	m/s <sup>2</sup>	4,72/1,5	3,47/1,5	2,6/1,5	2,8/1,5	<2,5/1,5
<b>L<sub>pA</sub>/K<sub>pA</sub></b>	dB(A)	91/3	88/3	86/3	81/3	80/3
<b>L<sub>WA</sub>/K<sub>WA</sub></b>	dB(A)	99/3	96/3	94/3	89/3	88/3

<b>n<sub>0</sub></b>	<b>RWEV 1200-2</b>		<b>RWEV 1600-2</b>		<b>RW 18 LTX BL 120</b>	<b>RW 18 LTX BL 140-2</b>	
	I	II	I	II	I	I	II
1	150	300	150	300	420	140	300
2	180	370	180	370	500	170	360
3	210	440	210	440	580	200	420
4	240	510	240	510	660	220	480
5	270	580	270	580	740	250	550
6	300	650	300	650	820	280	610



\*2) 2014/30/EU, 2006/42/EC, 2011/65/EU

\*3) EN 62841-1:2015+A11:2022, EN 62841-2-10:2017, EN IEC 63000:2018

2024-04-02, Bernd Fleischmann  
 Direktor Produktentstehung & Qualität (Vice President Product Engineering & Quality)

\*4) Metabowerke GmbH - Metabo-Allee 1 - 72622 Nuertingen, Germany

# Original instructions

## 1. Declaration of Conformity

We, being solely responsible: Hereby declare that these stirrers, identified by type and serial number \*1), meet the requirements of all relevant directives \*2) and standards \*3). Technical documents for \*4) - see page 3.

### For UK only:

**UK** We as manufacturer and authorized person to **CA** compile the technical file, see \*4) on page 3, hereby declare under sole responsibility that these stirrers, identified by type and serial number \*1) on page 3, fulfill all relevant provisions of following UK Regulations S.I. 2016/1091, S.I. 2008/1597, S.I. 2012/3032 and Designated Standards see \*3) on page 3.

## 2. Specified Conditions of Use

The stirrer is intended for stirring of powdery building materials such as mortar, plaster, adhesive as well as solvent-free paints, lacquer and similar substances.

Do not use for drilling.

The user bears sole responsibility for any damage caused by inappropriate use.

Generally accepted accident prevention regulations and the enclosed safety information must be observed.

## 3. General Safety Information



For your own protection and for the protection of your power tool, pay attention to all parts of the text that are marked with this symbol!



**WARNING** – Read the operating instructions to reduce the risk of injury.



**WARNING** – Read all safety warnings, instructions, illustrations and specifications provided with this power tool. Failure to follow all instructions listed below may result in electric shock, fire and/or serious injury.

**Save all warnings and instructions for future reference.**

Always include these documents when passing on your power tool.

## 4. Special Safety Instructions

**a) Hold the tool with both hands at the intended handles.** Loss of control can cause personal injury.

**b) Ensure sufficient ventilation when mixing flammable materials to avoid a hazardous atmosphere.** Developing vapour may be inhaled or be ignited by the sparks the power tool produces.

**c) Do not mix food.** Power tools and their accessories are not designed for processing food.

**d) Keep the cord away from the working area.** The cord may be entangled by the mixer basket.

**e) Ensure that the mixing container is placed in a firm and secure position.** A container that is not properly secured may move unexpectedly.

**f) Ensure that no liquid splashes against the housing of the power tool.** Liquid that has penetrated the power tool can cause damage and lead to electric shock.

**g) Follow the instructions and warnings for the material to be mixed.** Material to be mixed may be harmful.

**h) If the power tool falls into the material to be mixed, unplug the tool immediately and have the power tool checked by a qualified repair person.** Reaching into the bucket with the tool still plugged in can lead to electric shock.

**i) Do not reach into the mixing container with your hands or insert any other objects into it while mixing.** Contact with the stirrer basket may lead to serious personal injury.

**j) Start up and run down the tool in the mixing container only.** The mixer basket may bend or spin in an uncontrolled manner.

### Additional Safety Instructions:

Observe the maximum permitted stirrer basket diameter (see technical data).

There will be reverse torque at the handle. Always hold the machine with both hands on the designated handles, take a secure stance and concentrate on the work.

Secure the stirring container against turning.

Always wear protective goggles, gloves, and a breathing mask when working with the machine.

Wear ear protectors when working for long periods of time. High noise levels over a prolonged period of time may affect your hearing.

Keep hands away from the rotating tool!

Do not mix solvents or materials containing solvents with a flashpoint below 21 °C. Hazardous vapours or explosive mixtures may form during processing.

### Reducing dust exposure:

**WARNING** - Some dust created by power sanding, sawing, grinding, drilling, and other construction activities contains chemicals known to cause cancer, birth defects or other reproductive harm. Some examples of these chemicals are:

- Lead from lead-based paints,
- crystalline silica from bricks and cement and other masonry products, and
- arsenic and chromium from chemically treated lumber.

Your risk from these exposures varies, depending on how often you do this type of work. To reduce your exposure to these chemicals, work in a well-ventilated area, and work with approved safety equipment, such as those dust masks that are specially designed to filter out microscopic particles.

This also applies to dust from other materials, such as some timber types (like oak or beech dust), metals, asbestos. Other known diseases are e.g. allergic reactions, respiratory diseases. Do not let dust enter the body.

Observe the relevant guidelines and national regulations for your material, staff, application and place of application (e.g. occupational health and safety regulations, disposal).

Collect the particles generated at the source, avoid deposits in the surrounding area.

Use suitable accessories for special work. In this way, fewer particles enter the environment in an uncontrolled manner.

Use a suitable extraction unit.

Reduce dust exposure with the following measures:

- do not direct the escaping particles and the exhaust air stream towards yourself or nearby persons or towards dust deposits,
- use an extraction unit and/or an air purifier,
- ensure good ventilation of the workplace and keep it clean using a vacuum cleaner. Sweeping or blowing stirs up dust.
- Vacuum or wash protective clothing. Do not blow, beat or brush protective gear.

#### 4.1 Special safety instructions for mains powered machines:

Pull the plug out of the socket before making any adjustments, changing tools, carrying out maintenance or cleaning.

Avoid inadvertent starts by always unlocking the switch when the plug is removed from the mains socket or whenever the power fails.

#### 4.2 Special safety instructions for cordless machines:

Remove the battery pack from the machine before making any adjustments, changing tools, maintaining or cleaning.

 Protect battery packs from water and moisture!

 Do not expose battery packs to fire!

Do not use faulty or deformed battery packs!  
Do not open battery packs!

Do not touch or short circuit battery pack contacts!

 A slightly acidic, flammable fluid may leak from defective Li-Ion battery packs!

 If battery fluid leaks out and comes into contact with your skin, rinse immediately with plenty of water. If battery fluid leaks out and comes into contact with your eyes, wash them with clean water and seek medical attention immediately!

If the machine is defective, remove the battery pack from the machine.

#### Transport of Li-Ion battery packs:

The shipping of Li-Ion battery packs is subject to laws related to the carriage of hazardous goods (UN

3480 and UN 3481). Inform yourself of the currently valid specifications when shipping Li-Ion battery packs. If necessary, consult your freight forwarder. Certified packaging is available from Metabo.

Only send the battery pack if the housing is intact and no fluid is leaking. Remove the battery pack from the machine for sending. Prevent the contacts from short-circuiting (e.g. by protecting them with adhesive tape).

## 5. Overview

See page 2.

- 1 Spindle
- 2 Thumb-wheel for gear selection \*
- 3 Trigger switch
- 4 Trigger lock (and locking knob for continuous operation for RWEV ... and RW 18 LTX ...)
- 5 Speed preselection wheel \*
- 6 Handles
- 7 Capacity indicator button \*
- 8 Capacity and signal indicator \*
- 9 Battery pack \*
- 10 Battery pack release button \*

\* depending on the model / features

## 6. Initial Operation

### 6.1 For mains powered machines only

 Before commissioning, check that the rated mains voltage and mains frequency stated on the type plate match your power supply.

 Always install an RCD with a maximum trip current of 30 mA upstream.

### 6.2 For cordless machines only

#### Battery pack

Charge the battery pack (9) before use.

Recharge the battery pack if performance diminishes.

Instructions on charging the battery pack can be found in the operating instructions of the Metabo charger.

Battery packs have a capacity and signal indicator (8) (depends on design variant):

- Press the button (7), the LEDs indicate the charge level.
- The battery pack is almost empty and must be recharged if one LED is flashing.

#### Removing and inserting the battery pack

**Remove:** Press the battery pack release button (10) and remove battery pack (9).

**To insert:** Slide the battery pack (9) in until it engages.

## 7. Use

### 7.1 Tool change

#### Attaching the agitator paddle:

Screw the agitator paddle into the spindle (1). Hold the spindle (1) using an open-ended wrench and fix the agitator paddle using a second open-ended wrench.

Note: If needed screw in the supplied extension piece.

#### Remove the tool:

Hold the spindle (1) using an open-ended wrench and remove the agitator paddle using a second open-ended wrench.

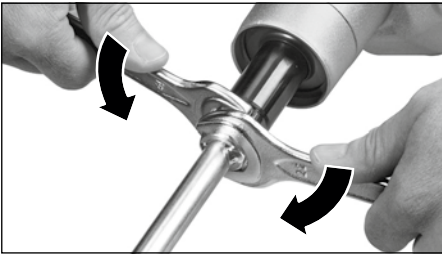

### 7.2 Select the gear (depending on features)

Select the required gear by rotating the thumb wheel (2).

Change speed when the motor is at a standstill or the machine is in the process of running down (briefly switch it on and off).

- I = 1. gear  
(low speed, high torque)
- II = 2. gear  
(high speed)

### 7.3 Adjusting the max. speed (depending on features)

Pre-select the maximum speed on the setting wheel (5) and change while working if needed.

Speed table, see page 3.

### 7.4 Switching On and Off Changing the speed

 Always hold the machine with both hands on the designated handles, take a secure stance and concentrate on the work.

**Switching on, changing the speed:** Press the trigger lock (4) and keep pressed, then press the trigger switch (3). Release the locking button (4).

Press in the trigger switch to increase the rotational speed.

To switch off release the trigger switch (3).

#### Continuous operation (not for RWE 1200):

 RWEV 1200-2, RWEV 1600-2, RW 18 LTX BL 120: When set to continuous operation, the machine will keep running even if it is snatched from the hand.

Switch on the machine and with the trigger (3) pressed, push in the locking button (4) completely and then released the trigger (3). Release the locking button (4).

Press and release the trigger (3) again to switch off.

## 8. Cleaning

Clean the agitator paddle after each use.

Clean the machine regularly.

## 9. Troubleshooting

### 9.1 Mains powered machines:

#### **There is a MAJOR reduction in load speed:**

##### **Overload protection:**

The motor temperature is too high! Allow the machine to run at idle speed until it has cooled down. Use an agitator paddle suited for the application. For RWEV...: set first gear

#### **There is a MINOR reduction in load speed:**

##### **Overload protection:**

The machine is overloaded. Reduce the load before continuing to work. Use an agitator paddle suited for the application. For RWEV...: set first gear

#### **The machine does not start:**

##### **Restart protection**

Restart protection is active. If the mains plug is inserted with the machine switched on or if the power supply is restored following an interruption, the machine does not start up. Switch the machine off and back on again.

### 9.2 Cordless machines:

#### **1 x beep, the machine does not start:**

##### **Restart protection**

Restart protection is active. The machine will not start if the battery pack is inserted while the machine is on. Switch the machine off and back on again.

#### **2 x beep, the machine was switched off automatically:**

##### **Overload protection:**

The machine is overloaded. Reduce the load before continuing to work. For RW 18 LTX BL 140-2: set first gear Use an agitator paddle suited for the application. If the machine is too warm: let run in idle until the machine has cooled down.

#### **3 x beep, the machine was switched off automatically when set to continuous operation (Only for RW 18 LTX BL 140-2):**

##### **Safety stop.**

For safe and clean working: Quick stop in the event of jamming or loss of control. Grasp the machine firmly with both hands on the designated handles, switch it off and then back on, and proceed with normal operation.

## 10. Accessories

Use only original Metabo or CAS (Cordless Alliance System) battery packs and accessories.

Use only accessories that fulfil the requirements and specifications listed in these operating instructions.

**Chargers:** ASC 145, etc.

**Battery packs with different capacities.** Buy battery packs only with voltage suitable for your power tool.

5.5 Ah (LiHD), order no.: 625368000

8.0 Ah (LiHD), order no.: 625369000

10.0 Ah (LiHD), order no.: 625549000  
etc.

4.0 Ah (Li-Power), order no.: 625027000  
etc.

See [www.metabo.com](http://www.metabo.com) or the catalogue for a complete range of accessories.

## 11. Repairs

Repairs to electrical tools must only be carried out by qualified electricians!

A defective mains cable must be replaced only with a special, original mains cable from Metabo available from the Metabo service.

Contact your local Metabo representative if you have Metabo power tools requiring repairs. For addresses see [www.metabo.com](http://www.metabo.com).

You can download a list of spare parts from [www.metabo.com](http://www.metabo.com).

## 12. Environmental Protection

Observe national regulations on environmentally compatible disposal and on the recycling of disused machines, packaging and accessories.

Packaging materials must be disposed of according to their labelling in accordance with municipal guidelines. Further information can be found at [www.metabo.com](http://www.metabo.com) in the "Service" section.

 Only for EU countries: never dispose of power tools in your household waste!  
 According to European Directive 2012/19/EU on Waste from Electric and Electronic Equipment and implementation in national law, used power tools must be collected separately and recycled in an environmentally-friendly manner.

### Special notes regarding cordless machines:

Battery packs may not be disposed of with regular waste. Return faulty or used battery packs to your Metabo dealer!

Do not allow battery packs to come into contact with water!

Discharge the battery pack in the power tool before disposal. Prevent the contacts from short-circuiting (e.g. by protecting them with adhesive tape).

## 13. Technical Specifications

Explanatory notes regarding the specifications on page 3.

Subject to change in accordance with technical progress.

- $P_1$  = Rated input
- $P_2$  = Power output
- $U$  = Voltage of battery pack
- $n_0$  = Idle speed
- $n_1$  = On-load speed
- $G$  = Tool mount (thread)
- $D_R$  = maximum permitted diameter/width of the mixing paddle
- $D$  = Collar diameter
- $m$  = Weight with smallest battery pack/weight (without cord)

Measured values determined in conformity with EN 62841.

Permitted ambient temperature during operation: -20 °C (-4°F) to 50 °C (120°F) (limited performance with temperatures below 0 °C (32°F)). Permitted ambient temperature for storage: 0 °C (32°F) to 30 °C (86°F).

 Machine in protection class II

~ AC Power

== direct current

The technical specifications quoted are subject to tolerances (in compliance with relevant valid standards).

### Emission values

These values make it possible to assess the emissions from the power tool and to compare different power tools. The actual load may be higher or lower depending on operating conditions, the condition of the power tool or the accessories used. Please allow for breaks and periods when the load is lower for assessment purposes. Arrange protective measures for the user, such as organisational measures based on the adjusted estimates.

Vibration total value (vector sum of three directions) determined in accordance with EN 62841:

$a_{h,D}$  = Vibration emission value

$K_{h,D}$  = Uncertainty (vibration)

Typical A-effective perceived sound levels:

$L_{pA}$  = Sound pressure level

$L_{WA}$  = Sound power level

$K_{pA}, K_{WA}$  = Uncertainty

 **Wear ear protectors!**