

Profile Cutters and Limiters
Profilmesser und Begrenzer
Profilové nože a omezovače



Application: shaping, broaching and thickening
Machine: shapers, multilateral profile millers, surfacers and thickeners

Anwendung: Profilieren, Durchziehen und Dickenbearbeitung
Maschine: Unterfräsmaschine, mehrseitige Profilfräsmaschine Abgleich- und Dickenfräsmaschine

Použití: profilování, protahování a tloušťkování
Stroj: spodní frézky, vícestranné profilování frézky, srovnávací a tloušťkovací frézky

Characteristics:

- » width 40 mm, thickness 4 mm
- » knives can operate with limiters (manual shift) or without (machine shift)
- » knife material – tool steel, SP
- » limiter material – structural steel, SP
- » the limiter prevents tool “kicking” at manual feed
- » the limiter has a profile cut 0,8 mm deeper

Charakteristik:

- » Breite 40 mm, Dicke 4 mm
- » die Messer können mit Begrenzer (manueller Vorschub) oder ohne (maschineller Vorschub) arbeiten
- » Messermaterial – Werkzeugstahl, SP
- » Begrenzermaterial – Konstruktionsstahl
- » der Begrenzer verhindert das „Schlagen“ der Maschine bei Handbearbeitung
- » der Begrenzer hat einen um 0,8 mm tieferen Profilschliff

Characteristics:

- » šířka 40 mm, tloušťka 4 mm
- » nože můžou pracovat s omezovači (ruční posuv) nebo bez (strojní posuv)
- » materiál nože - nástrojová ocel, SP
- » materiál omezovače - konstrukční ocel
- » omezovač zabraňuje „kopání“ nástroje při ručním obrábění
- » omezovač má výbrus profilu hlubší o 0,8 mm

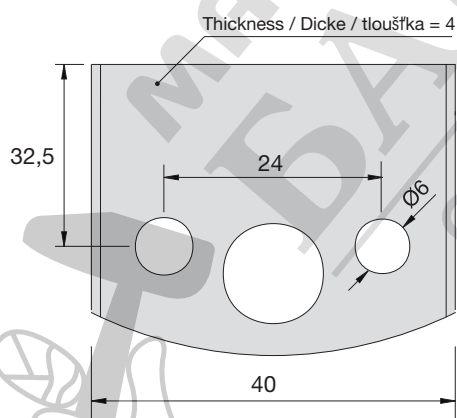
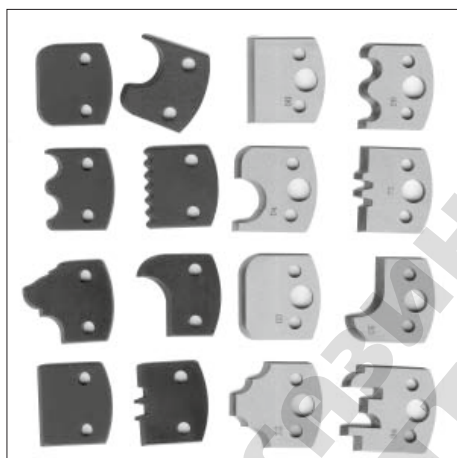

Semiproduks for Profile Cutter Cut

- » Semiproduks of both limiters and profile knives are in the same dimensions
- » For maximum profile depth up to 16 mm

Halbzeuge für Profilmesserschleif

- » Halbzeuge für Begrenzer und Profilmesser haben die gleichen Abmessungen
- » für maximale Profiltiefe bis 16 mm

Polotovary pro výbrus profilového nože

- » Polotovar omezovače i profilového nože mají stejné rozměry
- » Pro maximální hloubku profilu do 16 mm

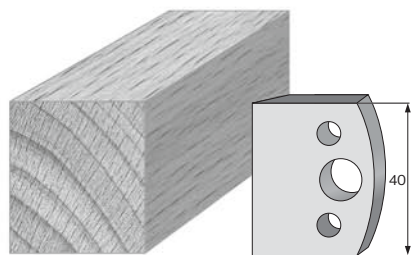

Profile number **00**
 Profilnummer
 Číslo profilu

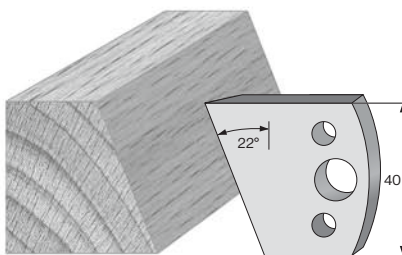

Profile number **01**
 Profilnummer
 Číslo profilu

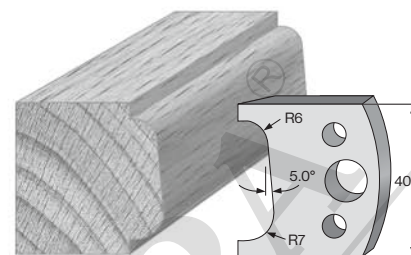

Profile number **02**
 Profilnummer
 Číslo profilu

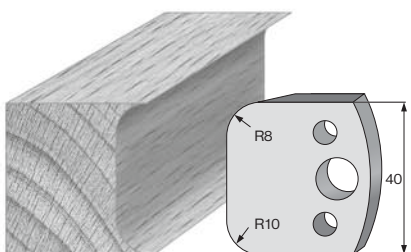

Profile number **03**
 Profilnummer
 Číslo profilu

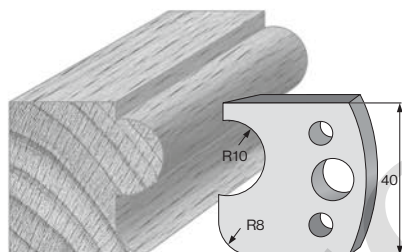

Profile number **04**
 Profilnummer
 Číslo profilu

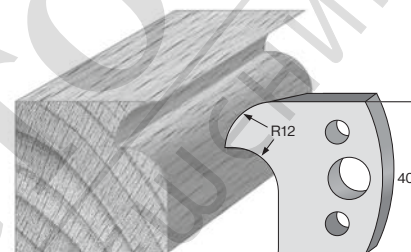

Profile number **05**
 Profilnummer
 Číslo profilu

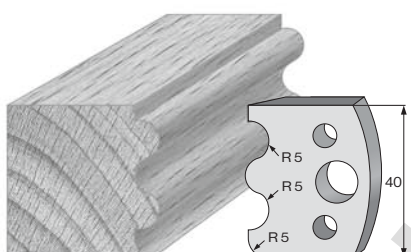

Profile number **06**
 Profilnummer
 Číslo profilu

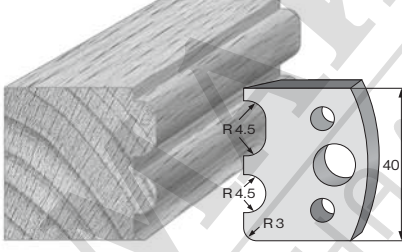

Profile number **07**
 Profilnummer
 Číslo profilu

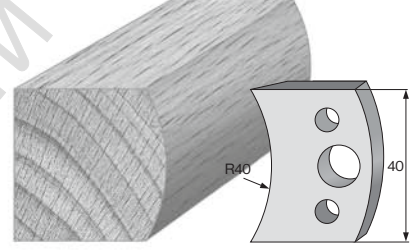

Profile number **08**
 Profilnummer
 Číslo profilu

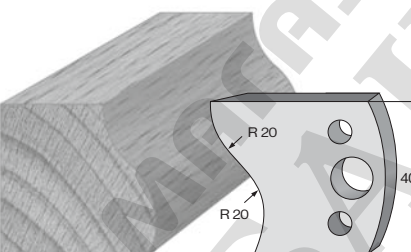

Profile number **09**
 Profilnummer
 Číslo profilu

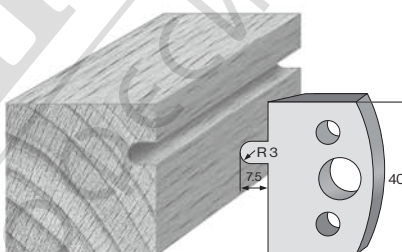

Profile number **10**
 Profilnummer
 Číslo profilu

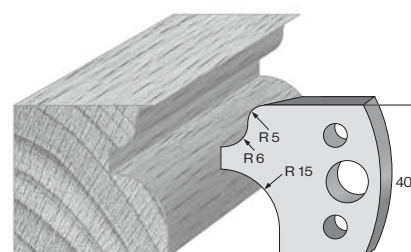

Profile number **11**
 Profilnummer
 Číslo profilu

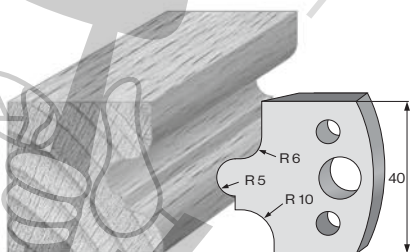

Profile number **12**
 Profilnummer
 Číslo profilu

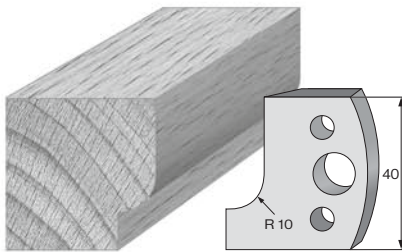

Profile number **13**
 Profilnummer
 Číslo profilu

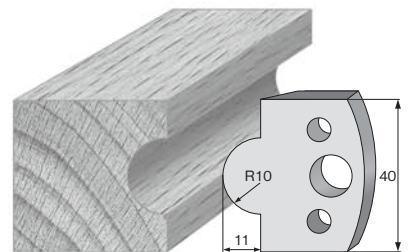

Profile number **14**
 Profilnummer
 Číslo profilu

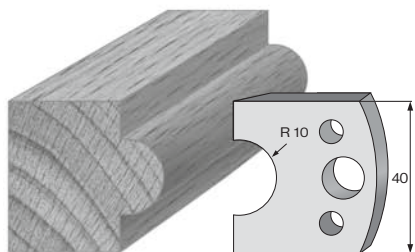

Profile number **15**
 Profilvernummer
 Číslo profilu

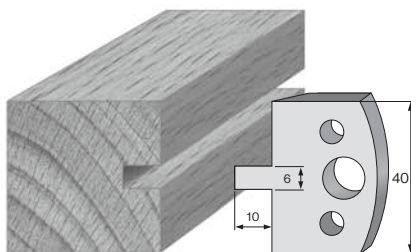

Profile number **16**
 Profilvernummer
 Číslo profilu

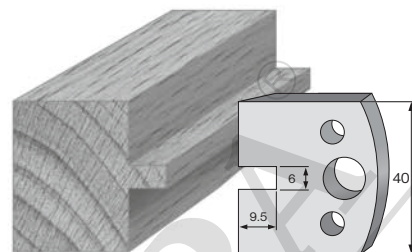

Profile number **17**
 Profilvernummer
 Číslo profilu

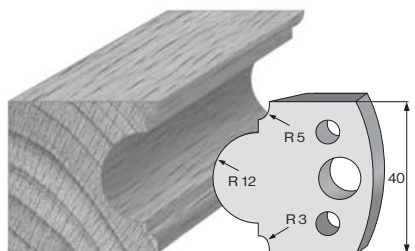

Profile number **18**
 Profilvernummer
 Číslo profilu

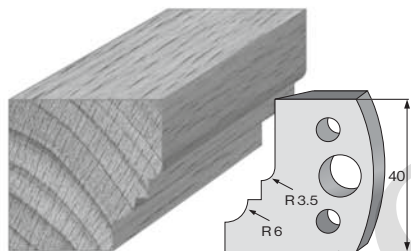

Profile number **19**
 Profilvernummer
 Číslo profilu

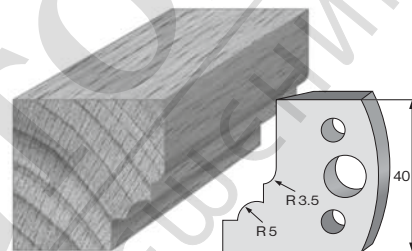

Profile number **20**
 Profilvernummer
 Číslo profilu

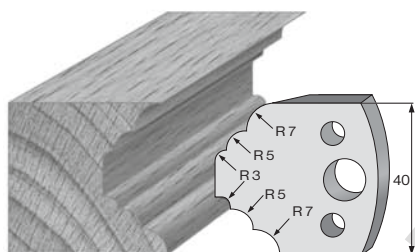

Profile number **21**
 Profilvernummer
 Číslo profilu

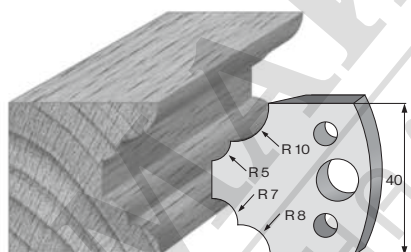

Profile number **22**
 Profilvernummer
 Číslo profilu

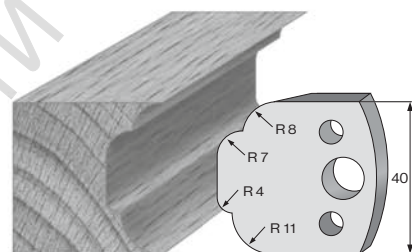

Profile number **23**
 Profilvernummer
 Číslo profilu

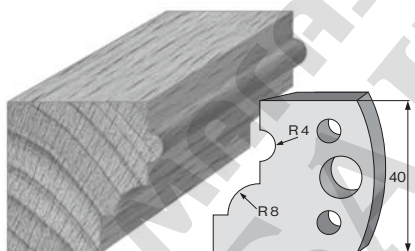

Profile number **24**
 Profilvernummer
 Číslo profilu

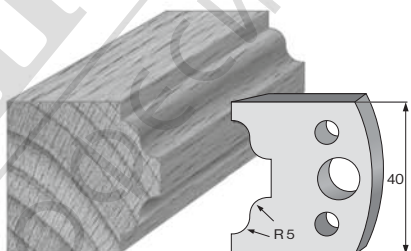

Profile number **25**
 Profilvernummer
 Číslo profilu

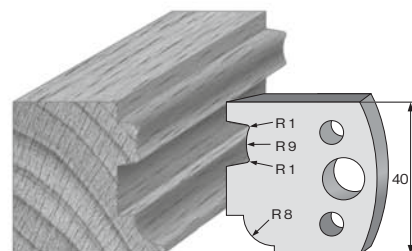

Profile number **26**
 Profilvernummer
 Číslo profilu

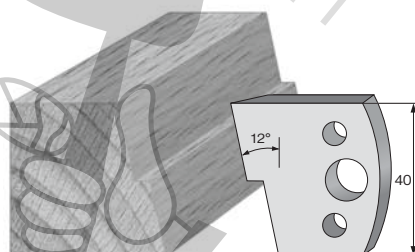

Profile number **27**
 Profilvernummer
 Číslo profilu

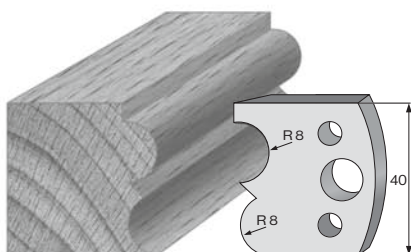

Profile number **28**
 Profilvernummer
 Číslo profilu

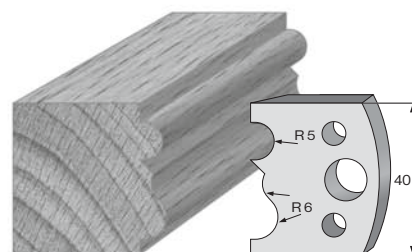

Profile number **29**
 Profilvernummer
 Číslo profilu

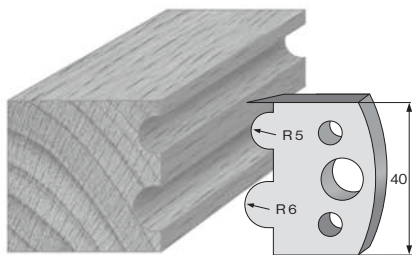

Profile number **30**
 Profilnummer
 Číslo profilu

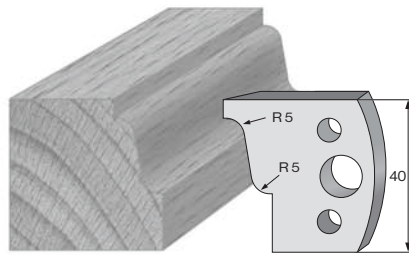

Profile number **31**
 Profilnummer
 Číslo profilu

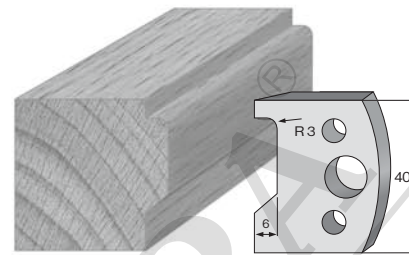

Profile number **32**
 Profilnummer
 Číslo profilu

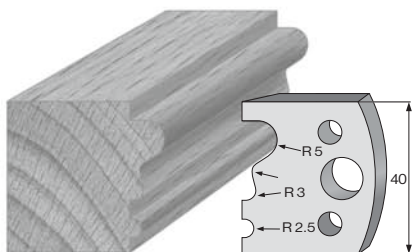

Profile number **33**
 Profilnummer
 Číslo profilu

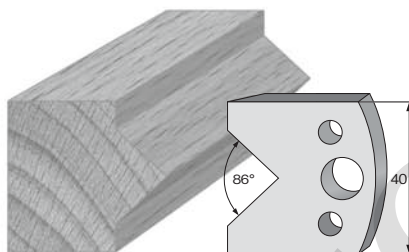

Profile number **34**
 Profilnummer
 Číslo profilu

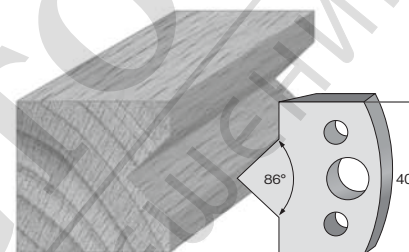

Profile number **35**
 Profilnummer
 Číslo profilu

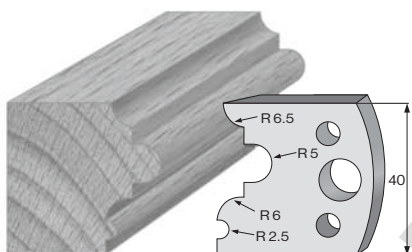

Profile number **36**
 Profilnummer
 Číslo profilu

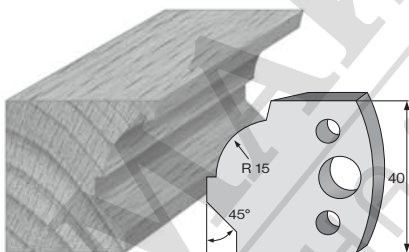

Profile number **37**
 Profilnummer
 Číslo profilu

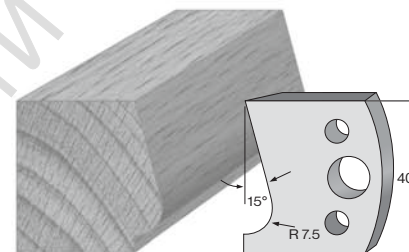

Profile number **38**
 Profilnummer
 Číslo profilu

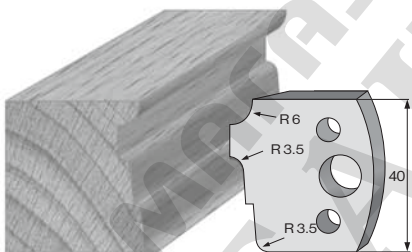

Profile number **39**
 Profilnummer
 Číslo profilu

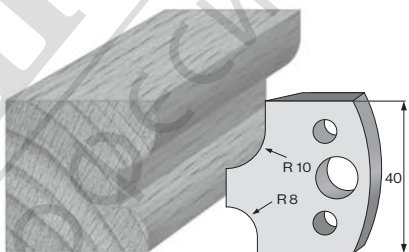

Profile number **40**
 Profilnummer
 Číslo profilu

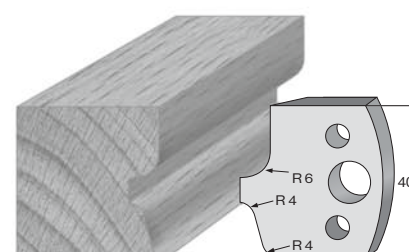

Profile number **41**
 Profilnummer
 Číslo profilu

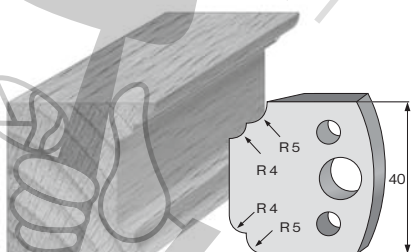

Profile number **42**
 Profilnummer
 Číslo profilu

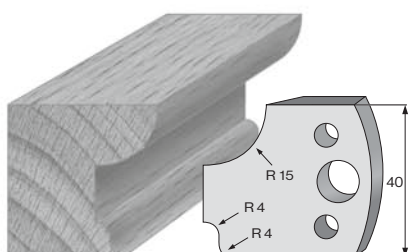

Profile number **43**
 Profilnummer
 Číslo profilu

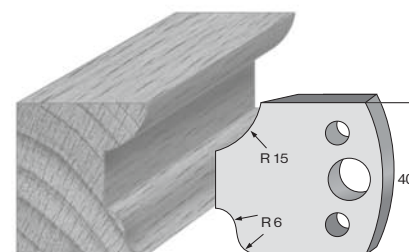

Profile number **44**
 Profilnummer
 Číslo profilu

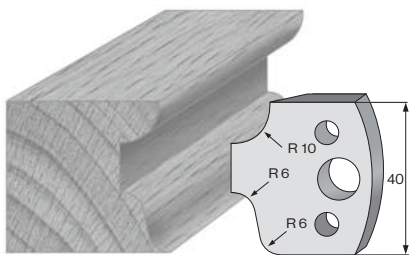

Profile number **45**
 Profilvernummer
 Číslo profilu

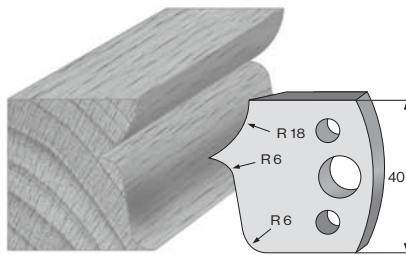

Profile number **46**
 Profilvernummer
 Číslo profilu

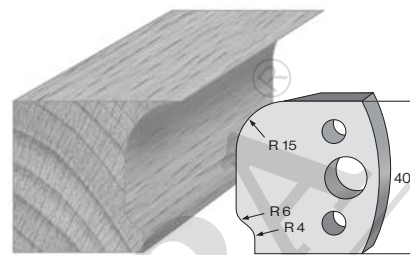

Profile number **47**
 Profilvernummer
 Číslo profilu

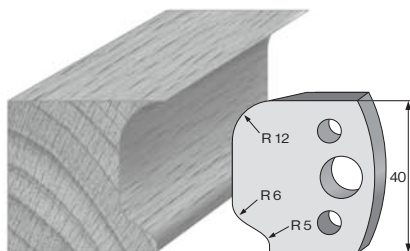

Profile number **48**
 Profilvernummer
 Číslo profilu

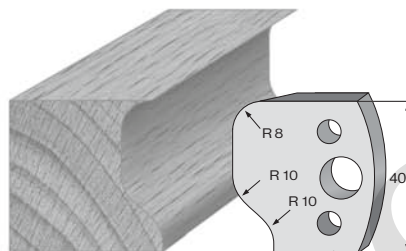

Profile number **49**
 Profilvernummer
 Číslo profilu

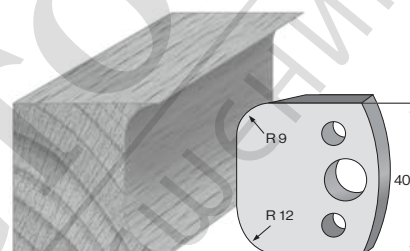

Profile number **50**
 Profilvernummer
 Číslo profilu

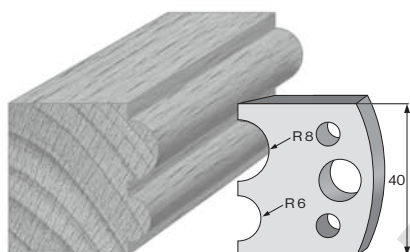

Profile number **51**
 Profilvernummer
 Číslo profilu

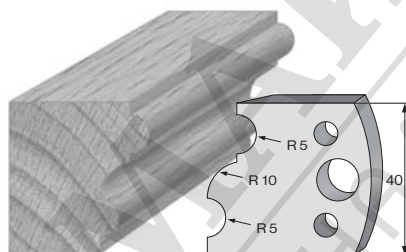

Profile number **52**
 Profilvernummer
 Číslo profilu

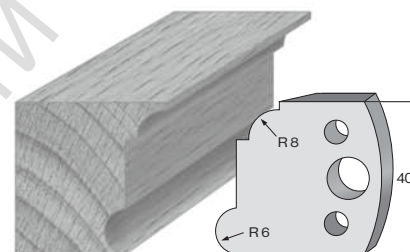

Profile number **53**
 Profilvernummer
 Číslo profilu

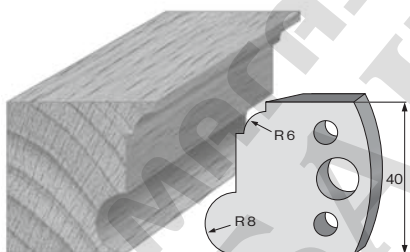

Profile number **54**
 Profilvernummer
 Číslo profilu

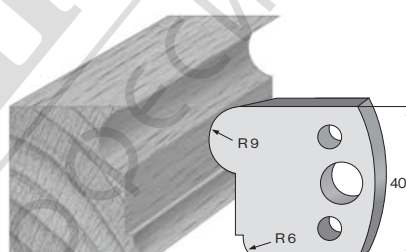

Profile number **55**
 Profilvernummer
 Číslo profilu

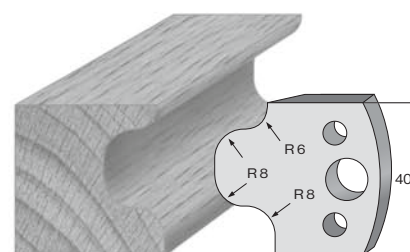

Profile number **56**
 Profilvernummer
 Číslo profilu

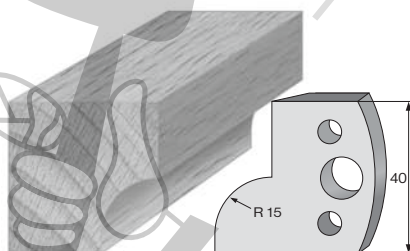

Profile number **57**
 Profilvernummer
 Číslo profilu

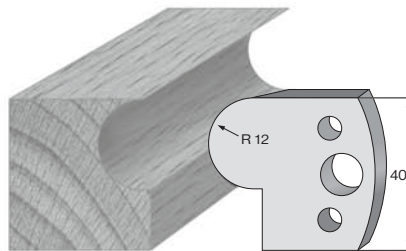

Profile number **58**
 Profilvernummer
 Číslo profilu

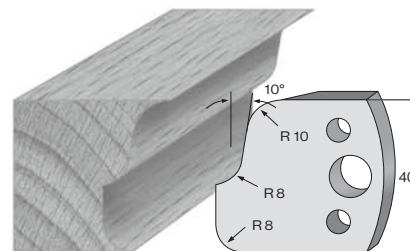

Profile number **59**
 Profilvernummer
 Číslo profilu

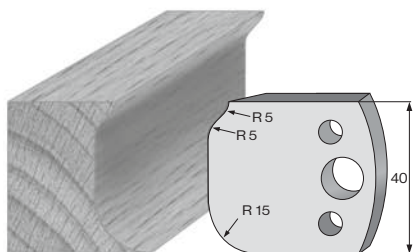

Profile number **60**
 Profilnummer
 Číslo profilu

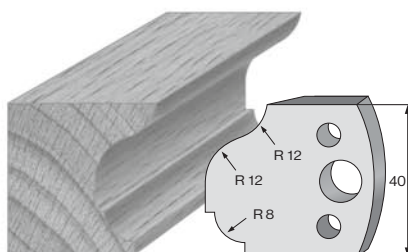

Profile number **61**
 Profilnummer
 Číslo profilu

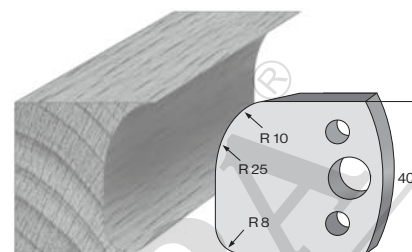

Profile number **62**
 Profilnummer
 Číslo profilu

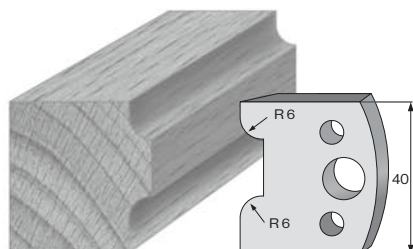

Profile number **63**
 Profilnummer
 Číslo profilu

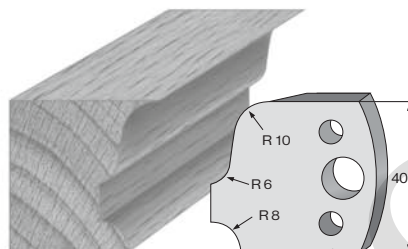

Profile number **64**
 Profilnummer
 Číslo profilu

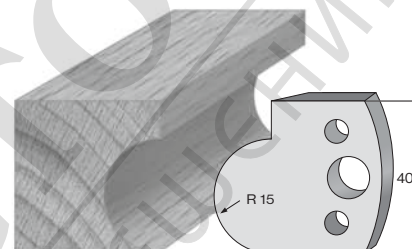

Profile number **65**
 Profilnummer
 Číslo profilu

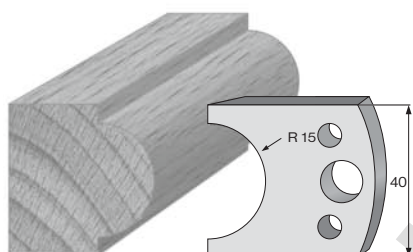

Profile number **66**
 Profilnummer
 Číslo profilu

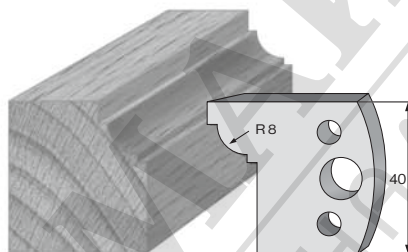

Profile number **67**
 Profilnummer
 Číslo profilu

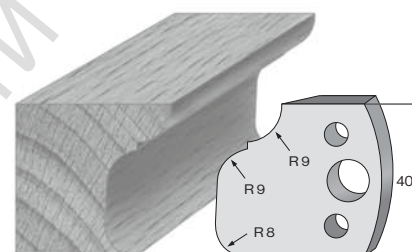

Profile number **68**
 Profilnummer
 Číslo profilu

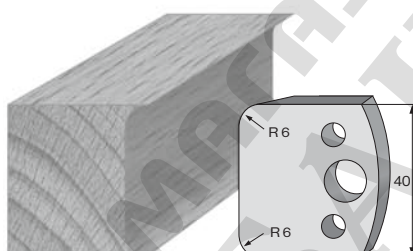

Profile number **69**
 Profilnummer
 Číslo profilu

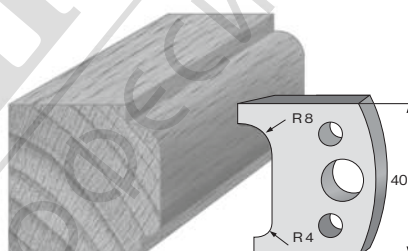

Profile number **70**
 Profilnummer
 Číslo profilu

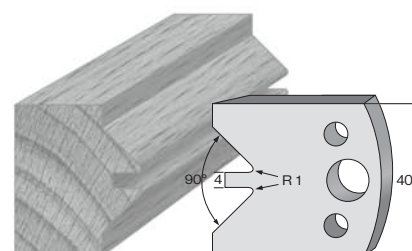

Profile number **71**
 Profilnummer
 Číslo profilu

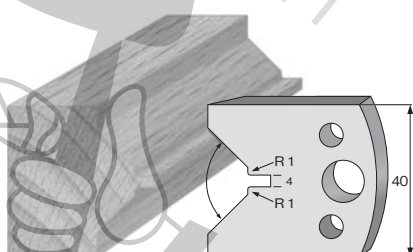

Profile number **72**
 Profilnummer
 Číslo profilu

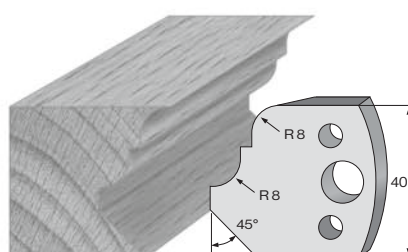

Profile number **73**
 Profilnummer
 Číslo profilu

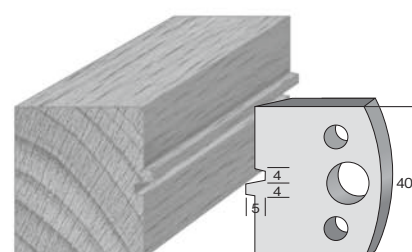

Profile number **74**
 Profilnummer
 Číslo profilu

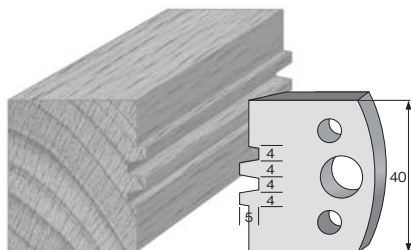

Profile number | **75**
 Profilnummer
 Číslo profilu

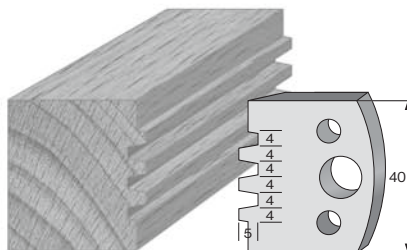

Profile number | **76**
 Profilnummer
 Číslo profilu

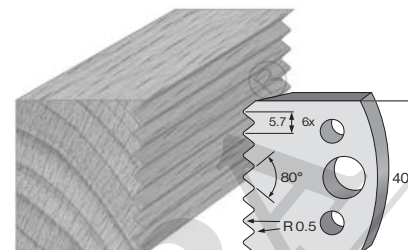

Profile number | **77**
 Profilnummer
 Číslo profilu

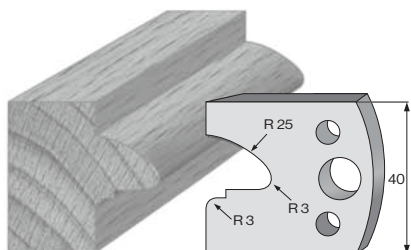

Profile number | **78**
 Profilnummer
 Číslo profilu

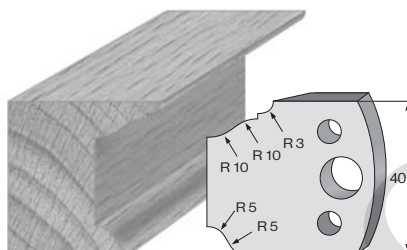

Profile number | **79**
 Profilnummer
 Číslo profilu

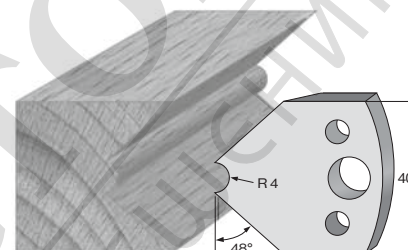

Profile number | **80**
 Profilnummer
 Číslo profilu

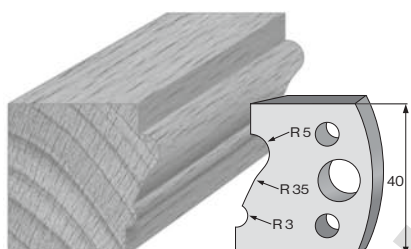

Profile number | **81**
 Profilnummer
 Číslo profilu

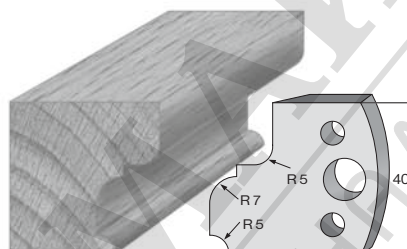

Profile number | **82**
 Profilnummer
 Číslo profilu

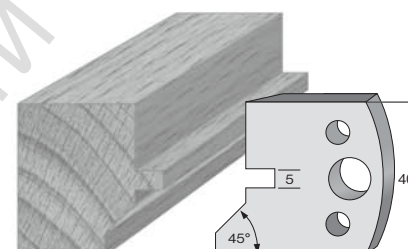

Profile number | **83**
 Profilnummer
 Číslo profilu

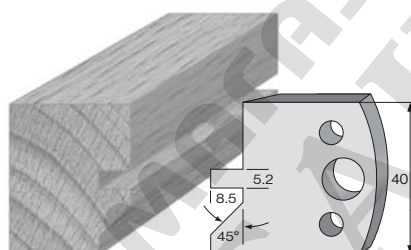

Profile number | **84**
 Profilnummer
 Číslo profilu

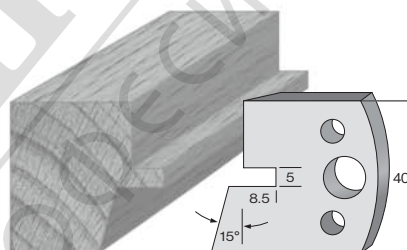

Profile number | **85**
 Profilnummer
 Číslo profilu

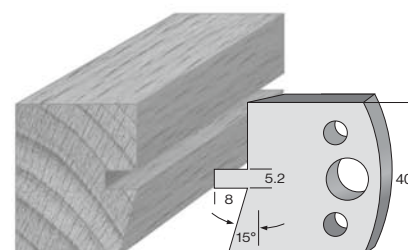

Profile number | **86**
 Profilnummer
 Číslo profilu

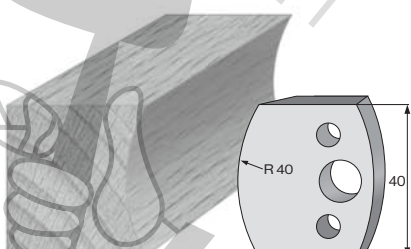

Profile number | **87**
 Profilnummer
 Číslo profilu

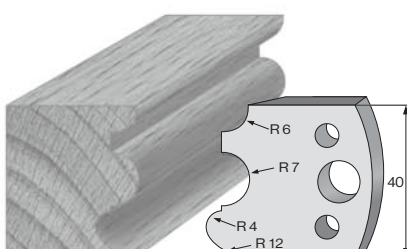

Profile number | **88**
 Profilnummer
 Číslo profilu

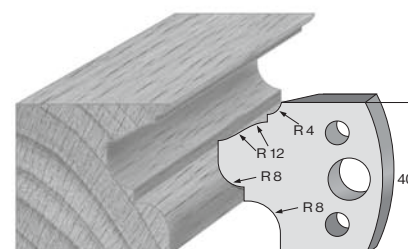

Profile number | **89**
 Profilnummer
 Číslo profilu



Profile Cutters and Limiters
Profilmesser und Begrenzer
Profilové nože a omezovače

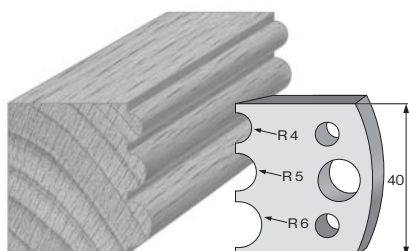

Profile number **90**
 Profilnummer
 Číslo profilu

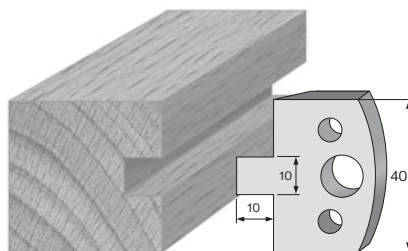

Profile number **91**
 Profilnummer
 Číslo profilu

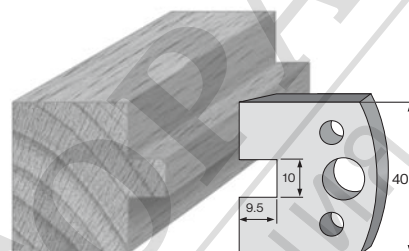

Profile number **92**
 Profilnummer
 Číslo profilu

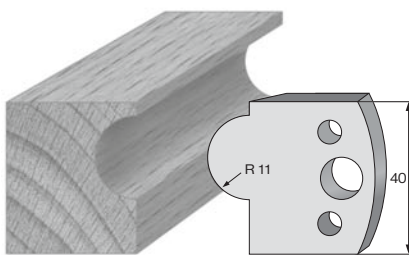

Profile number **93**
 Profilnummer
 Číslo profilu

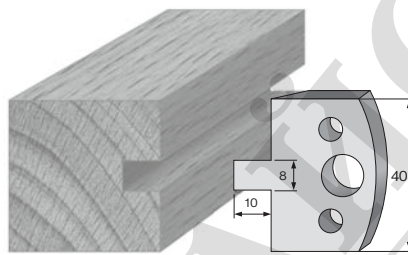

Profile number **94**
 Profilnummer
 Číslo profilu

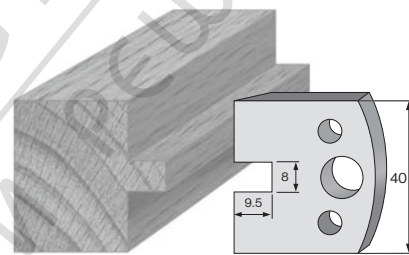

Profile number **95**
 Profilnummer
 Číslo profilu

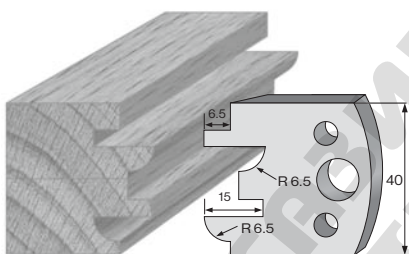

Profile number **96**
 Profilnummer
 Číslo profilu

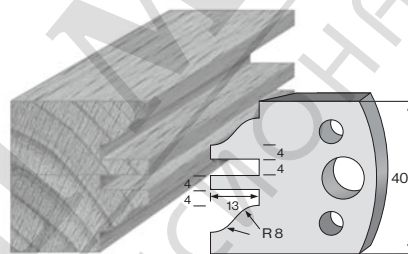

Profile number **97**
 Profilnummer
 Číslo profilu

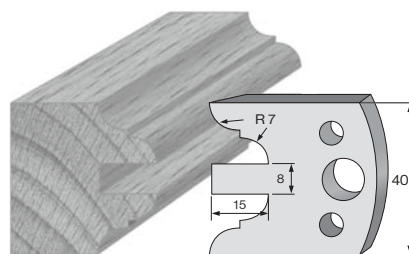

Profile number **98**
 Profilnummer
 Číslo profilu

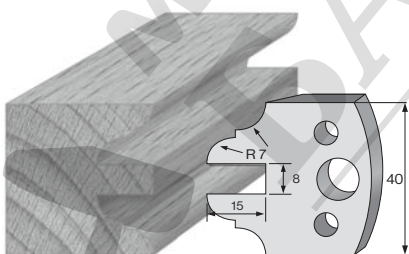

Profile number **99**
 Profilnummer
 Číslo profilu

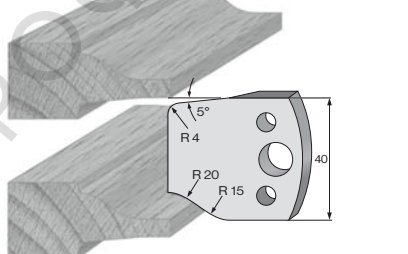

Profile number **100**
 Profilnummer
 Číslo profilu